



## User Guide

### Enterprise Router

This guide is for reference only and does not imply that the product supports all functions in the guide. The functions may differ with product models. The actual product prevails.

## Copyright statement

Copyright © 2023-2024 IP-COM Networks Co., Ltd. All rights reserved.

**IP-COM** is the registered trademark of IP-COM Networks Co., Ltd. Other brand and product names mentioned herein are trademarks or registered trademarks of their respective holders. Copyright of the whole product as integration, including its accessories and software, belongs to IP-COM Networks Co., Ltd. No part of this publication can be reproduced, transmitted, transcribed, stored in a retrieval system, or translated into any language in any form or by any means without the prior written permission of IP-COM Networks Co., Ltd.

## Disclaimer

Pictures, images and product specifications herein are for references only. To improve internal design, operational function, and/or reliability, IP-COM reserves the right to make changes to the products described in this document without obligation to notify any person or organization of such revisions or changes. IP-COM does not assume any liability that may occur due to the use or application of the product or circuit layout(s) described herein. Every effort has been made in the preparation of this document to ensure accuracy of the contents, but all statements, information and recommendations in this document do not constitute a warranty of any kind, express or implied.

# Preface

Thank you for choosing IP-COM. Please read this user guide before you start.

## Applicable models

This user guide is applicable to the IP-COM Enterprise Routers. All screenshots herein, unless otherwise specified, are taken from M30V3.0.

## Conventions

This guide is for reference only and does not imply that the product supports all functions in the guide. The functions supported by different models or different versions of the same model may differ. The actual product prevails.

The product figures and screenshots in this guide are for examples only. They may be different from the actual products you purchased, but do not affect the normal use.

If the function or parameter is displayed in gray on the product UI interface, the product model is not supported or cannot be modified.



In this guide, unless otherwise specified:

- The screenshots use the router mode as an example. For other working modes, the actual product prevails.
- The system version V1.5.6 of the ProFi cloud management is used as an example. The actual operation and UI interface of the system version prevail.
- The iOS system is used for illustration here.

The typographical elements that may be found in this document are defined as follows.

Item	Presentation	Example
Cascading menus	>	Choose <b>System</b> > <b>Live Users</b> .
Parameter and value	Bold	Set <b>User Name</b> to <b>Tom</b> .
Variable	Italic	Format: <i>XX:XX:XX:XX:XX:XX</i>
UI control	Bold	On the <b>Policy</b> page, click the <b>OK</b> button.

The symbols that may be found in this document are defined as follows.

Symbol	Meaning
 Note	This format is used to highlight information of importance or special interest. Ignoring this type of note may result in ineffective configurations, loss of data or damage to the device.
 Tip	This format is used to highlight a procedure that will save time or resources.

## For more documents

Go to our website at [www.ip-com.com.cn](http://www.ip-com.com.cn) and search for the latest documents for this product.

## Technical support

Contact us if you need more help. We will be glad to assist you as soon as possible.

Email address: [info@ip-com.com.cn](mailto:info@ip-com.com.cn)

Website: [www.ip-com.com.cn](http://www.ip-com.com.cn)

## Revision history

IP-COM is constantly searching for ways to improve its products and documentation. The following table indicates any changes that might have been made since the user guide was released.

Version	Date	Description
V2.2	2024-04-03	<ul style="list-style-type: none"><li>– Added the description of <a href="#">Wi-Fi optimization</a>, <a href="#">Wireless MAC filtering</a> and <a href="#">User filtering</a> function.</li><li>– Optimized the description of <a href="#">Login to the web UI in router mode</a>, <a href="#">Example of configuring the VLAN</a>, <a href="#">System status</a>, <a href="#">AP management</a> and <a href="#">Authentication</a>.</li><li>– Optimized sentence expression.</li></ul>
V2.1	2024-01-18	<ul style="list-style-type: none"><li>– Added the description of <a href="#">Authentication</a>, <a href="#">User group</a>, <a href="#">VPN access permission</a> and <a href="#">Network diagnosis</a> function.</li><li>– Optimized the description of <a href="#">View network info</a>, <a href="#">AP management</a>, <a href="#">Cloud maintenance</a> and <a href="#">VPN</a> function.</li><li>– Optimized sentence expression.</li></ul>
V1.1	2023-07-10	<ul style="list-style-type: none"><li>– Added <a href="#">model description</a> about M20-8G-PoE/M20-PoE.</li></ul>

Version	Date	Description
		– Added function description about <a href="#">VPN client</a> and <a href="#">connecting the router to the internet in pure AC mode</a> .
V1.0	2023-01-29	Original publication.

# Contents

<b>1 Operating mode .....</b>	<b>1</b>	4.6 View WAN real-time rate (Router mode) .....	22
1.1 Router mode.....	2	4.7 View number of online clients (Pure AC mode).....	23
1.1.1 Overview.....	2	<b>5 Network .....</b>	<b>24</b>
1.1.2 Set the router to operate in router mode.....	3	5.1 Internet settings.....	24
1.2 Pure AC mode.....	4	5.1.1 No. of WAN ports.....	24
1.2.1 Overview.....	4	5.1.2 Set the internet.....	25
1.2.2 Set the router to operate in pure AC mode.....	5	5.1.3 Check connection status.....	31
<b>2 Login and logout.....</b>	<b>6</b>	5.2 LAN settings .....	33
2.1 Login .....	6	5.3 LAN configuration information .....	35
2.1.1 LAN login.....	6	5.4 VLAN settings.....	36
2.1.2 Remote login.....	12	5.4.1 Overview.....	36
2.2 Logout.....	13	5.4.2 Example of configuring the VLAN .	38
<b>3 Web UI.....</b>	<b>14</b>	5.5 DHCP settings.....	46
3.1 Web layout.....	14	5.5.1 Overview.....	46
3.2 Common buttons.....	15	5.5.2 DHCP server .....	47
<b>4 System status .....</b>	<b>16</b>	5.5.3 DHCP reservation.....	49
4.1 View network information .....	16	5.5.4 DHCP list.....	51
4.2 View system resource information.....	17	<b>6 AP management .....</b>	<b>52</b>
4.3 View running quality monitoring.....	18	6.1 Overview .....	52
4.4 View statistics of terminals.....	19	6.2 Configuration wizard.....	53
4.5 View port information .....	20	6.3 AP management mode .....	54
		6.4 Wireless policy.....	56

6.4.1 SSID policy .....	56	7.4.3 Email .....	113
6.4.2 RF policy.....	59	7.4.4 Account.....	115
6.4.3 VLAN policy.....	63	7.4.5 No authentication.....	116
6.4.4 Advanced policy.....	65	7.4.6 PPPoE .....	117
6.5 AP group policy.....	70	7.4.7 Random code .....	119
6.6 AP list and maintenance .....	72	7.5 Configure guest policy .....	120
6.6.1 Overview.....	72	7.6 Account .....	122
6.6.2 Deliver policies to APs .....	75	7.6.1 User list .....	122
6.6.3 Batch settings .....	76	7.6.2 Account management.....	123
6.6.4 Set AP cloud maintenance.....	78	7.6.3 Charging policy.....	128
6.7 Wireless user information .....	81	7.6.4 Authentication-free policy .....	130
6.8 Exmample of configuring fat APs.....	83	7.6.5 Random code account .....	132
6.9 IPTV.....	90	7.7 Example of authentication for rented flats .....	134
6.9.1 Overview.....	90	7.7.1 Networking requirements.....	134
6.9.2 Watch IPTV programs (scenario 1)91		7.7.2 Solution.....	134
6.9.3 Watch IPTV programs (scenario 2)93		7.7.3 Configuration procedure.....	135
6.10 Wi-Fi optimization .....	97	7.7.4 Verification .....	140
6.10.1 Optimize wireless network.....	97	<b>8 Bandwidth limit .....</b>	<b>144</b>
6.10.2 Schedule optimization .....	98	8.1 WAN bandwidth.....	144
6.10.3 View Wi-Fi optimization record 100		8.2 Group limit.....	145
<b>7 Authentication .....</b>	<b>101</b>	8.3 Single user limit .....	146
7.1 Overview.....	101	8.3.1 Overview.....	146
7.2 Configuration wizard .....	103	8.3.2 Configure single user limit .....	148
7.3 Configure authentication templates ...	104	8.4 Example of configuring group speed limit .....	149
7.3.1 Image template.....	104	<b>9 Behavior&amp;Audit .....</b>	<b>152</b>
7.3.2 Text template .....	107	9.1 Group policy.....	152
7.4 Configure authentication type .....	110	9.1.1 Time group.....	152
7.4.1 Overview.....	110	9.1.2 IP group.....	154
7.4.2 SMS.....	111		

9.1.3 User group .....	155	10.3.1 Remote web management .....	229
9.2 Filtering.....	157	10.3.2 Security settings.....	232
9.2.1 IP address filtering.....	157	10.3.3 Cloud maintenance.....	233
9.2.2 MAC address filtering .....	161	10.3.4 Remote debugging.....	241
9.2.3 Port filtering.....	165	10.4 VPN .....	246
9.2.4 URL filtering .....	169	10.4.1 Overview.....	246
9.2.5 Wireless MAC filtering.....	174	10.4.2 PPTP/L2TP .....	247
9.2.6 User filtering.....	176	10.4.3 Example of configuring a PPTP/L2TP VPN .....	252
9.2.7 VPN access permission .....	180	10.4.4 Example of configuring an L2TP over IPSec VPN.....	258
9.3 Log auditing .....	184	10.4.5 IPSec.....	269
9.3.1 Audit settings.....	184	10.4.6 Example of configuring an IPSec VPN .....	282
9.3.2 Log storage .....	185	10.5 IPv6 .....	286
<b>10 More .....</b>	<b>186</b>	10.5.1 Overview.....	286
10.1 Advanced routing .....	186	10.5.2 Internet .....	286
10.1.1 WAN parameters .....	186	10.5.3 LAN.....	291
10.1.2 Multi-WAN policy .....	188	<b>11 System maintenance .....</b>	<b>293</b>
10.1.3 Static routing .....	192	11.1 System time .....	293
10.1.4 Routing table .....	198	11.1.1 Sync time with network time....	293
10.1.5 Policy routing.....	199	11.1.2 Set system time manually.....	294
10.2 Virtual service.....	204	11.2 Diagnostic tool .....	295
10.2.1 DMZ .....	204	11.2.1 Ping .....	295
10.2.2 DDNS.....	209	11.2.2 Tracert.....	296
10.2.3 DNS hijacking.....	214	11.2.3 Packet capture tool .....	297
10.2.4 IP hijacking.....	217	11.2.4 AP diagnosis.....	300
10.2.5 UPnP .....	220	11.2.5 System diagnosis.....	301
10.2.6 Port mirroring .....	221	11.2.6 Interface info.....	302
10.2.7 Port mapping .....	223	11.3 Log center .....	303
10.2.8 DNS cache .....	228		
10.3 Maintenance service .....	229		



11.3.1 System log.....	303	11.6 Reboot services.....	312
11.3.2 Operating log.....	303	11.6.1 Reboot.....	312
11.3.3 Running log.....	304	11.6.2 Scheduled reboot.....	312
11.4 Maintenance.....	305	11.7 Network diagnosis .....	314
11.4.1 Device information .....	305	11.7.1 Configure network diagnosis ....	314
11.4.2 Restore & Backup .....	305	11.7.2 Client detection .....	314
11.4.3 Factory settings restore .....	307	11.7.3 WAN port diagnosis .....	315
11.5 Upgrade service.....	309	11.7.4 Network monitoring logs.....	316
11.5.1 Overview.....	309	11.8 System account.....	317
11.5.2 System firmware upgrade .....	310	<b>Appendix.....</b>	<b>318</b>
11.5.3 Feature-Library upgrade .....	311		

# 1 Operating mode



The operating mode of the router may vary with models.

- For M20-PoE, only the router mode is allowed.
- For M20-8G-PoE/M30, the router mode and pure AC mode can be used.

---

Choose the appropriate mode according to the actual situation. The text description takes router mode as an example.

- [Router Mode](#): The device is used as a router and wireless controller, providing internet access, routing forward, AP management, behavior & audit and other functions. In this mode, the device needs to process both control packets and data packets.
- [Pure AC Mode](#): The device is used as a wireless controller to provide functions such as AP management, behavior & audit. Refer to the page display. In this mode, data packets no longer pass through the device, and the device only needs to process control packets.

# 1.1 Router mode

## 1.1.1 Overview

In router mode, the device is used as a router and wireless controller, which is generally deployed at the egress gateway to proxy the LAN to access the internet.

The application scenarios are as follows.

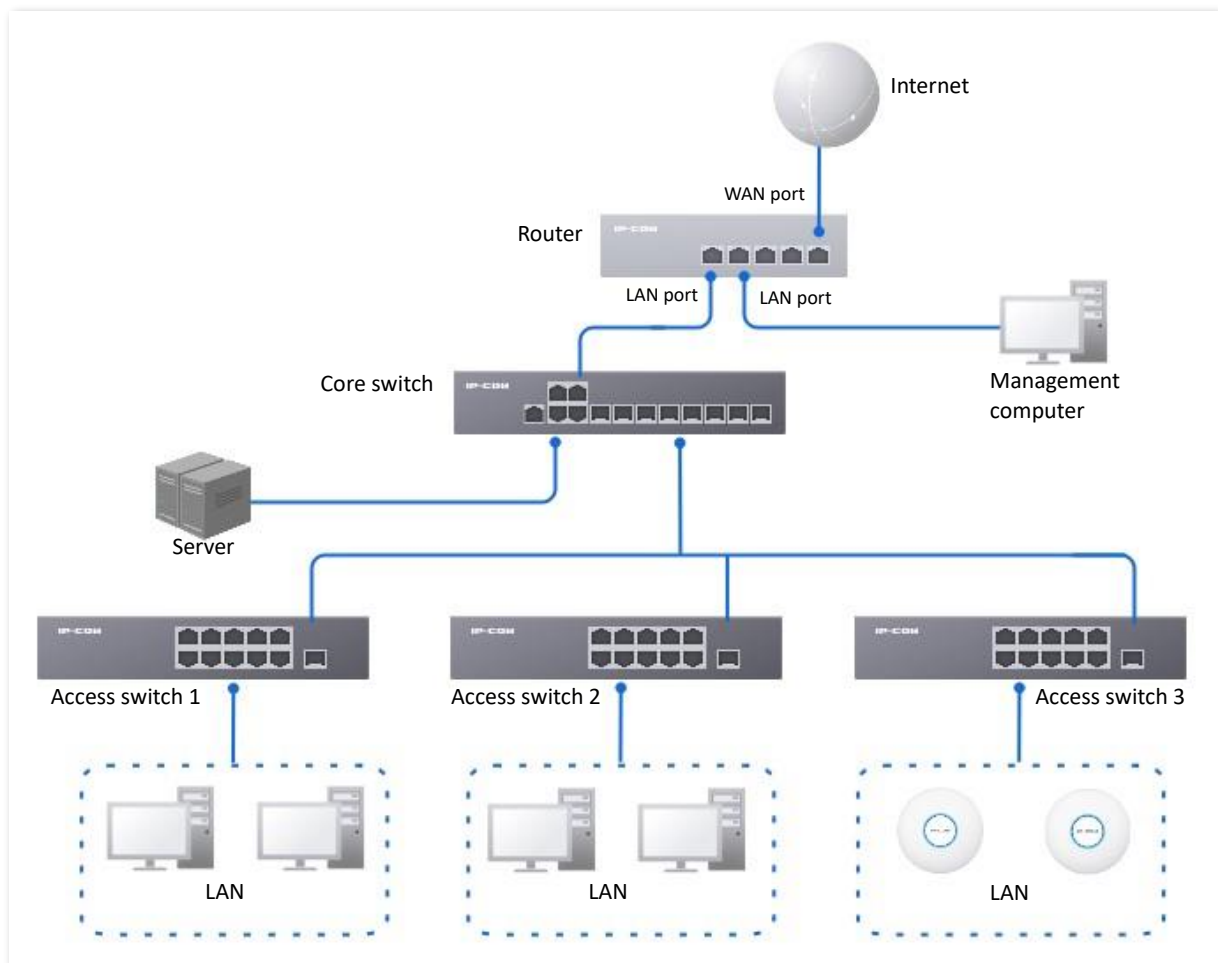

## 1.1.2 Set the router to operate in router mode

1. [Log in to the web UI of the router](#), and select **Router Mode** from the mode selection drop-down menu at the top right of the page. The following figure is for reference only.

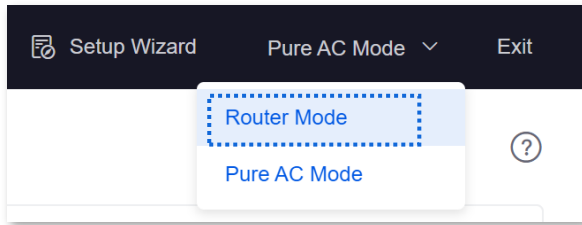

2. Confirm the prompt information and click **OK**.

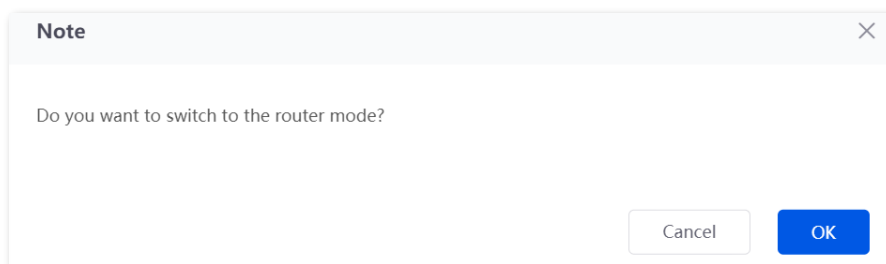

----End

## 1.2 Pure AC mode

### 1.2.1 Overview

In pure AC mode, the device is used as a wireless controller, which can be deployed under the core switch. Only some functions are supported.

The application scenarios are as follows.

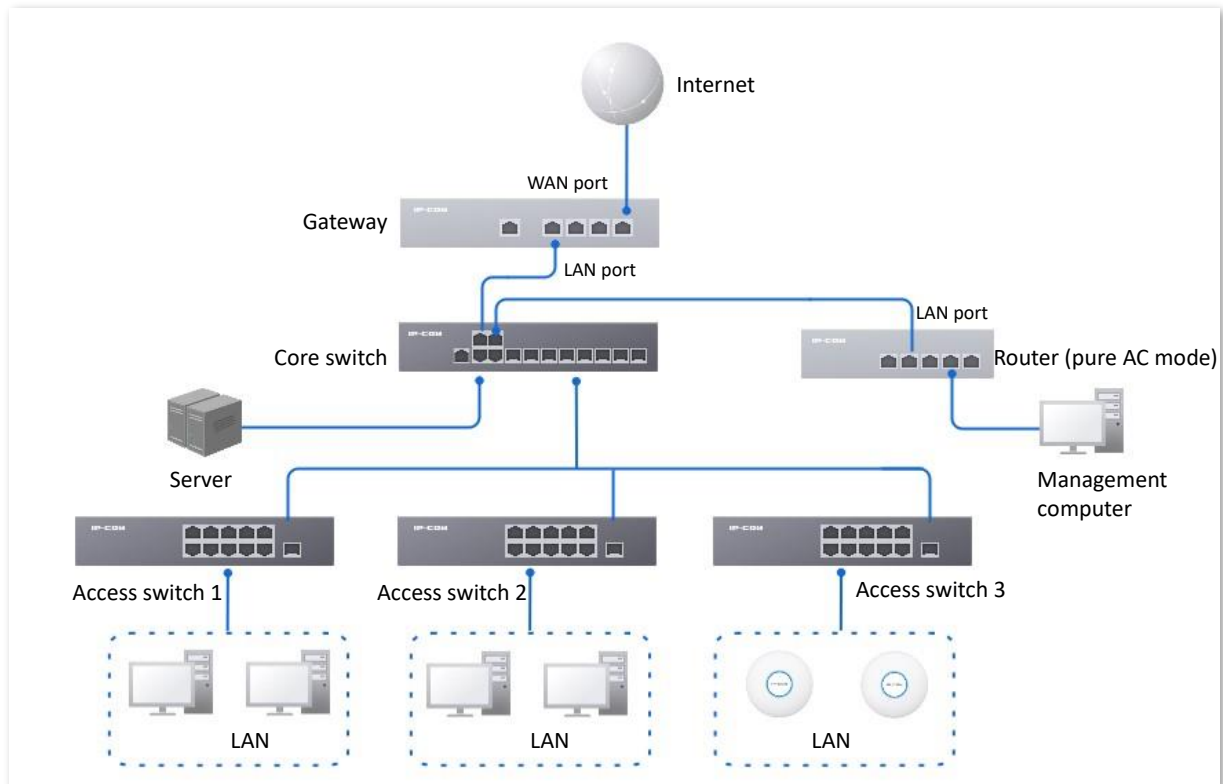

- The pure AC mode is supported by M20-8G-PoE and M30.
- In pure AC mode, if you want to use the [remote web management](#), [cloud maintenance](#), and [remote debugging](#) functions of the router, connect the router to the internet first. For details, refer to [Connect the router to the internet in Pure AC mode](#).

## 1.2.2 Set the router to operate in pure AC mode

1. [Log in to the web UI of the router](#), and select **Pure AC Mode** from the mode selection drop-down menu at the top right of the page. The following figure is for reference only.

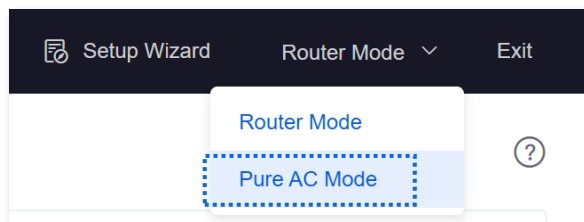

2. Confirm the prompt information and click **OK**.

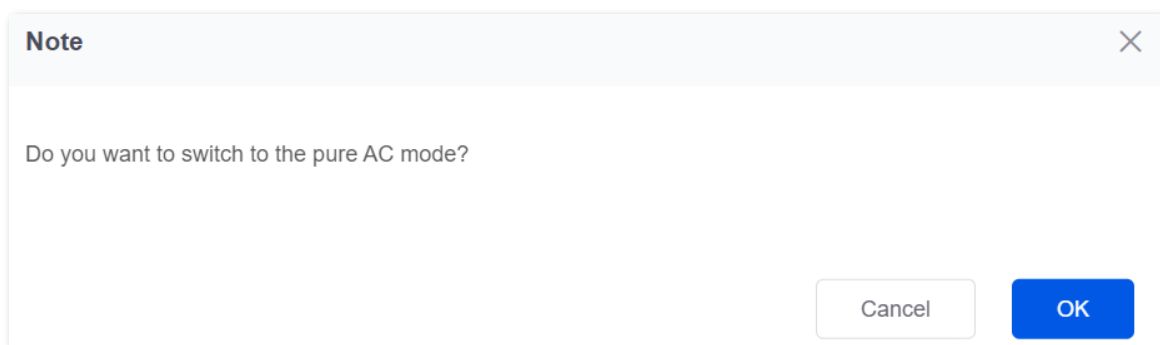

----End

# 2 Login and logout

## 2.1 Login

Upon your first use or reset of the router, you can set up the router by referring to the router's quick installation guide (visit [www.ip-com.com.cn](http://www.ip-com.com.cn) to download).

If you want to log in to the web UI of the router, follow the procedures below.

### 2.1.1 LAN login

#### Log in to the web UI in router mode

##### Login with computer

1. Use an Ethernet cable to connect the management computer to the LAN port of the router, or a switch connected to the LAN port of the router.
2. Start a web browser (such as Chrome) on your computer, and enter **ipcwifi.com** in the address bar to log in to the web UI.

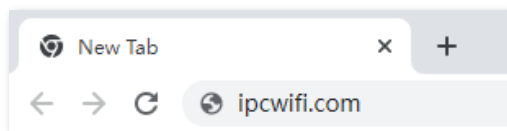

3. Enter the login password, and click **Log in**.

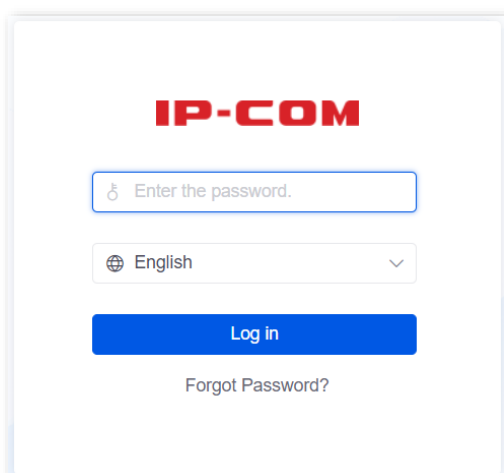

Or

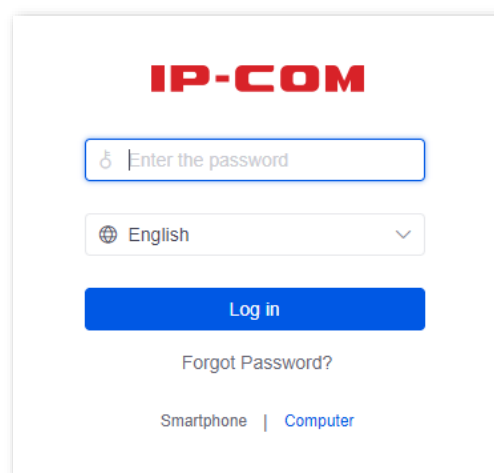



If the **Wrong password** is displayed on the page, try the following solutions:

- When you set up the router for the first time, the system will synchronize the wireless password as the login password by default. If you are not sure whether the login password has been set, enter the wireless password and try again.
- [Restore the router to factory settings](#) and retry. Note that the router must be connected to the internet again after restoration.

----End



If the above page does not appear, try the following solutions:

- Ensure that the management computer is properly connected and the Ethernet cable is not loose.
- Set your computer to **Obtain an IP address automatically** and **Obtain DNS server address automatically**.
- [Restore the router to factory settings](#) and retry. Note that the router must be connected to the internet again after restoration.

If the following page is displayed, you have logged in to the web UI successfully.

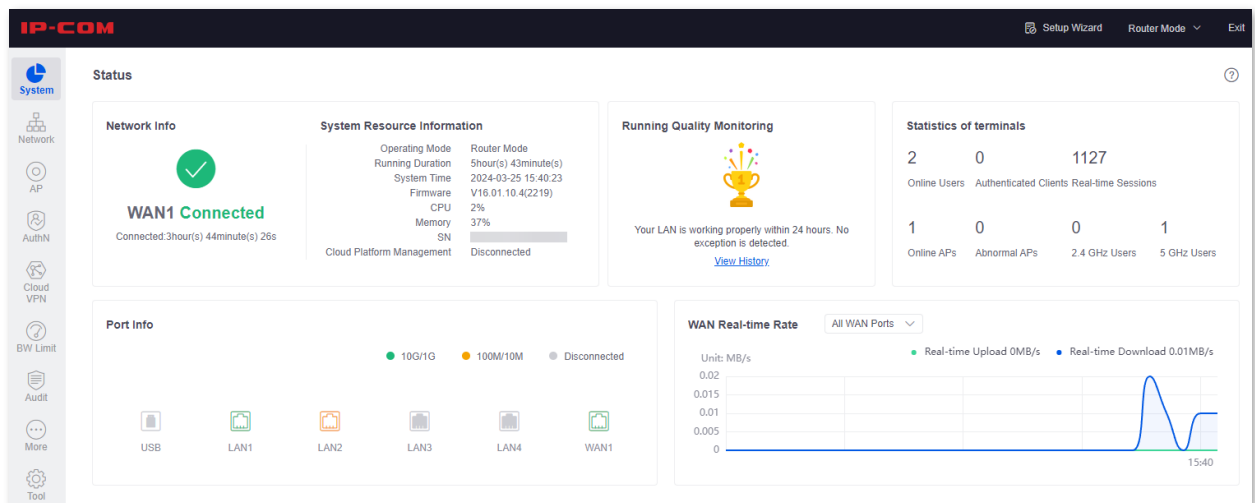



### Login with smartphone (Example: M30V3.1)

It is suitable for the router LAN port (PoE power supply supported) is connected to the AP or the PoE switch on the LAN side of the router is connected to the AP.

1. Connect a WiFi-enabled device such as a smartphone to the AP's wireless network.
  - APs that have been managed by the router: The SSID (wireless name) and wireless password have been set by you. If not, the default SSID is IP-COM\_XXXXXX (XXXXXX is the last six digits of the router's MAC address on the label of the router. No password by default).
  - APs that have not been managed by the router: The SSID and wireless password is the existing SSID and wireless password of the AP.
2. Start a browser on your smartphone, and enter **ipcwifi.com** in the address bar to log in to the web UI.
3. Enter the login password, and click **Log in**.

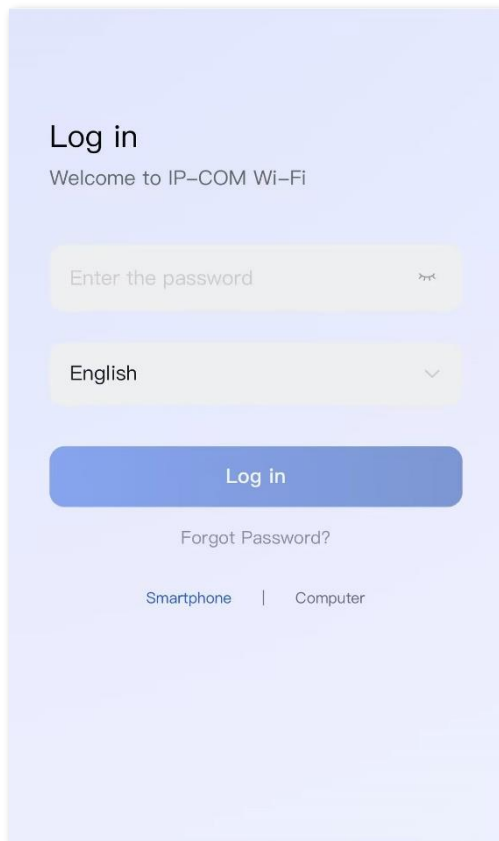



If the **Wrong password** is displayed on the page, try the following solutions:

- When you set up the router for the first time, the system will synchronize the wireless password as the login password by default. If you are not sure whether the login password has been set, enter the wireless password and try again.
- [Restore the router to factory settings](#) and retry. Note that the router must be connected to the internet again after restoration.

----End



If the above page does not appear, try the following solutions:

- Ensure that the AP is working properly and the smartphone is connected to the correct wireless network.
- When logging in using your smartphone, ensure that the cellular network (mobile data) of the device is disabled.
- [Restore the router to factory settings](#) and retry. Note that the router must be connected to the internet again after restoration.

If the following page is displayed, you have logged in to the web UI successfully.

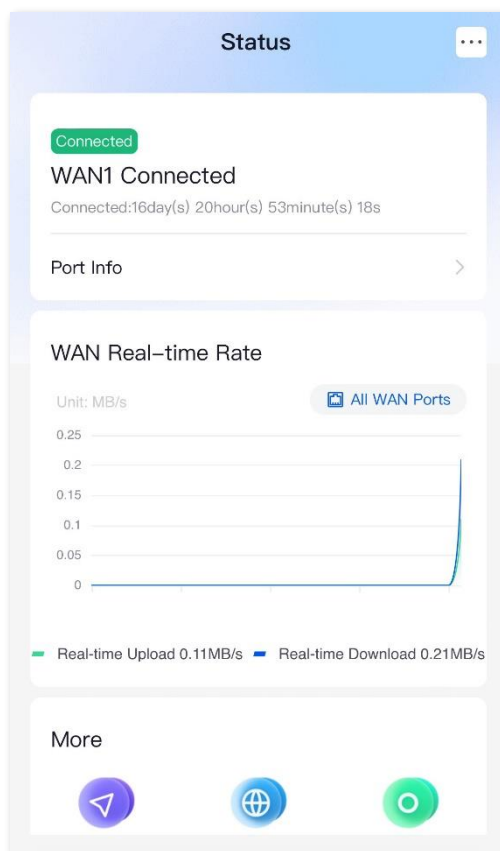

## Log in to the web UI in pure AC mode

1. Use an Ethernet cable to connect the management computer to the LAN port of the router, or a switch connected to the LAN port of the router.
2. Configure the IP address of the management computer to one in the same network segment as the router.

For example, if the IP address of the router is **192.168.0.252**, you can set the IP address of the computer to **192.168.0.X** (X ranges from 2 to 251 and is not occupied by other devices), and subnet mask to **255.255.255.0**.

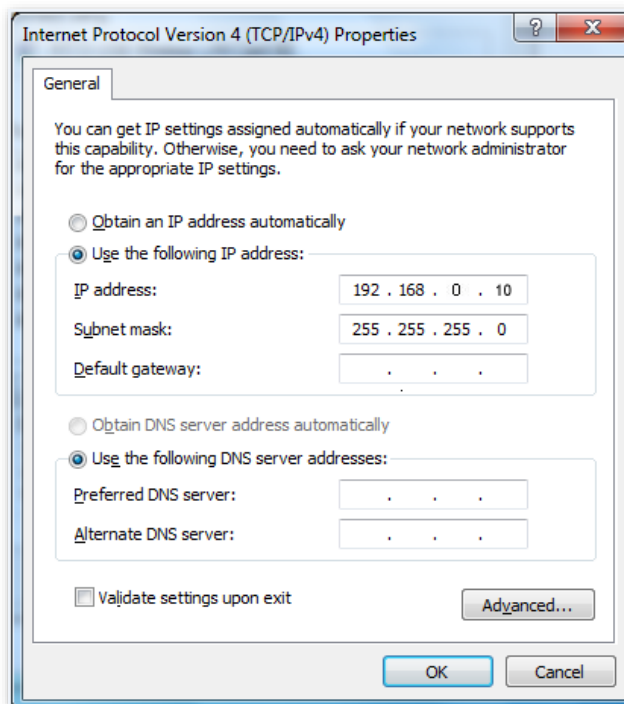

3. Start a browser on the computer and visit the IP address (**192.168.0.252** by default) of the router.

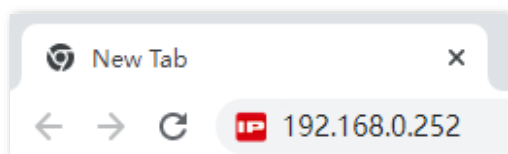

4. Enter the login password, and click **Log in**.

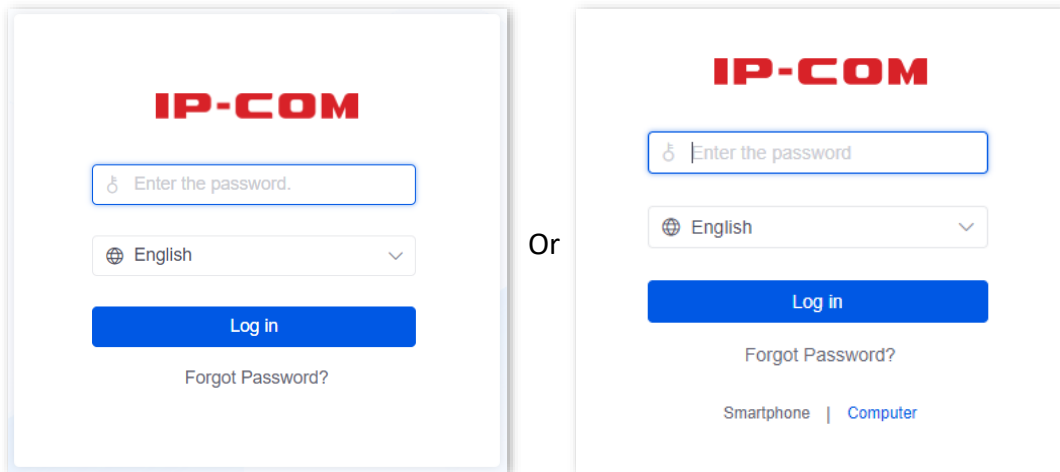

---End



- The pure AC mode is supported by M20-8G-PoE and M30.
- If the above page does not appear, ensure that the Ethernet port of the router is connected to the computer correctly and securely.

If the following page is displayed, you have logged in to the web UI successfully.

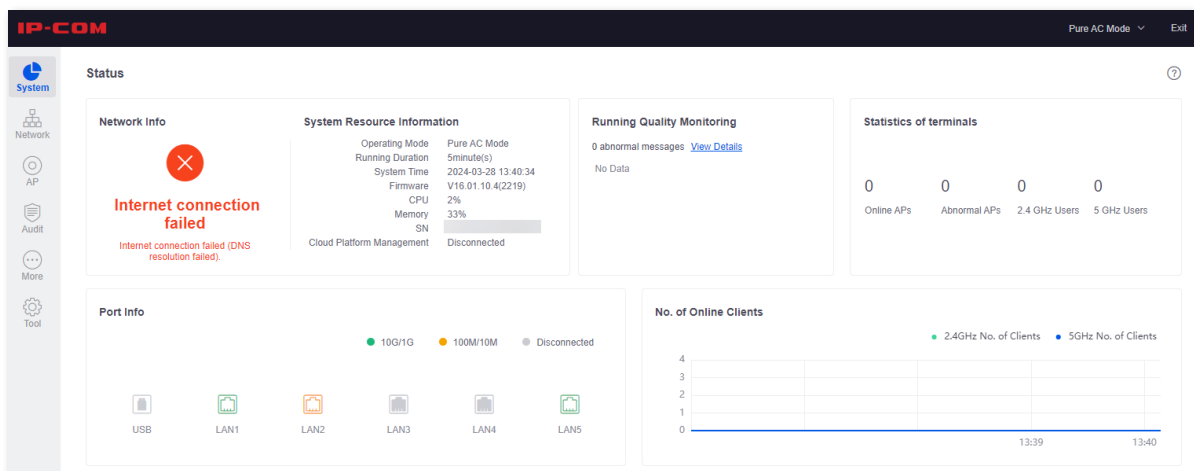

## 2.1.2 Remote login

The login mode is applicable when the router has enabled the [Remote Web Management](#) function.



Before using this mode to log in, ensure that your client has been allowed to remotely access the router.

1. Start a web browser (such as Chrome) on a client connected to the internet, and access the router's [remote management address](#). The following figure is for reference only.

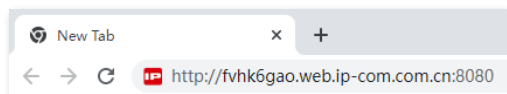

2. Enter the login password, and click **Log in**.

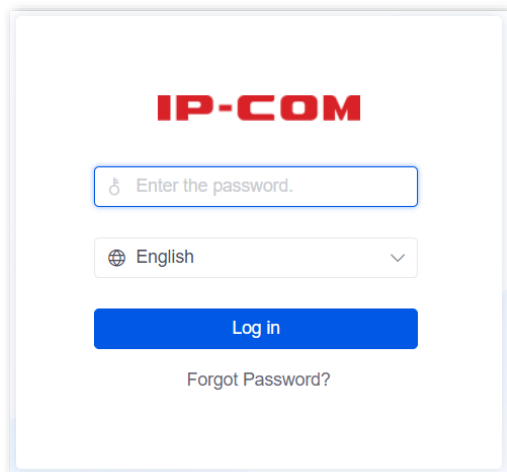

----End

If the following page is displayed, you have logged in to the web UI successfully.

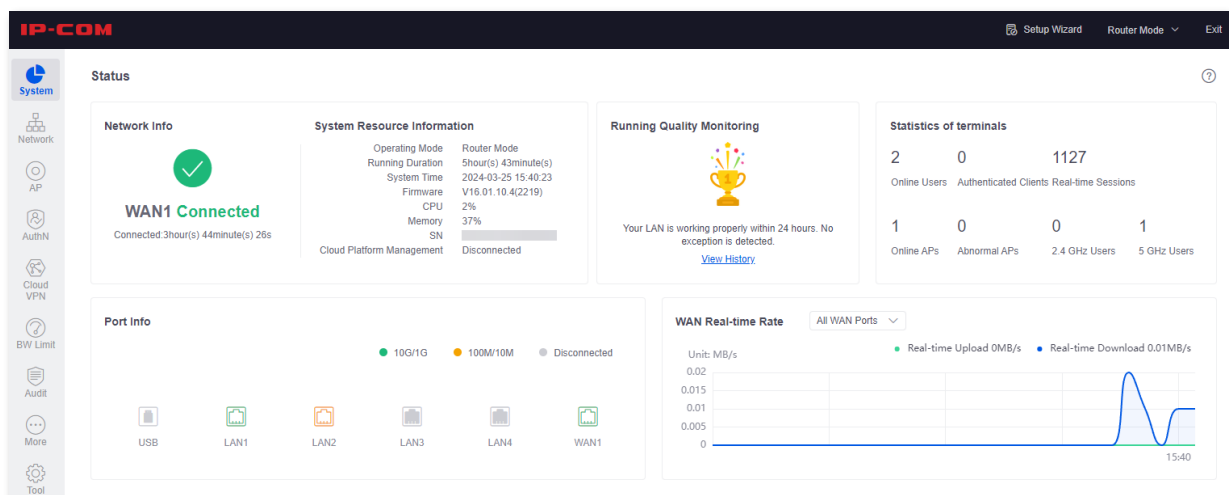

## 2.2 Logout

After you log in to the web UI of the router, the system will automatically log you out if there is no operation within the [Login Timeout](#). Alternatively, you can directly click **Exit** in the upper right corner to exit the web UI.

# 3 Web UI

## 3.1 Web layout

The web UI of the router consists of four sections, including the level-1 navigation bar, level-2 navigation bar, level-3 navigation bar and the configuration area. See the following figure.

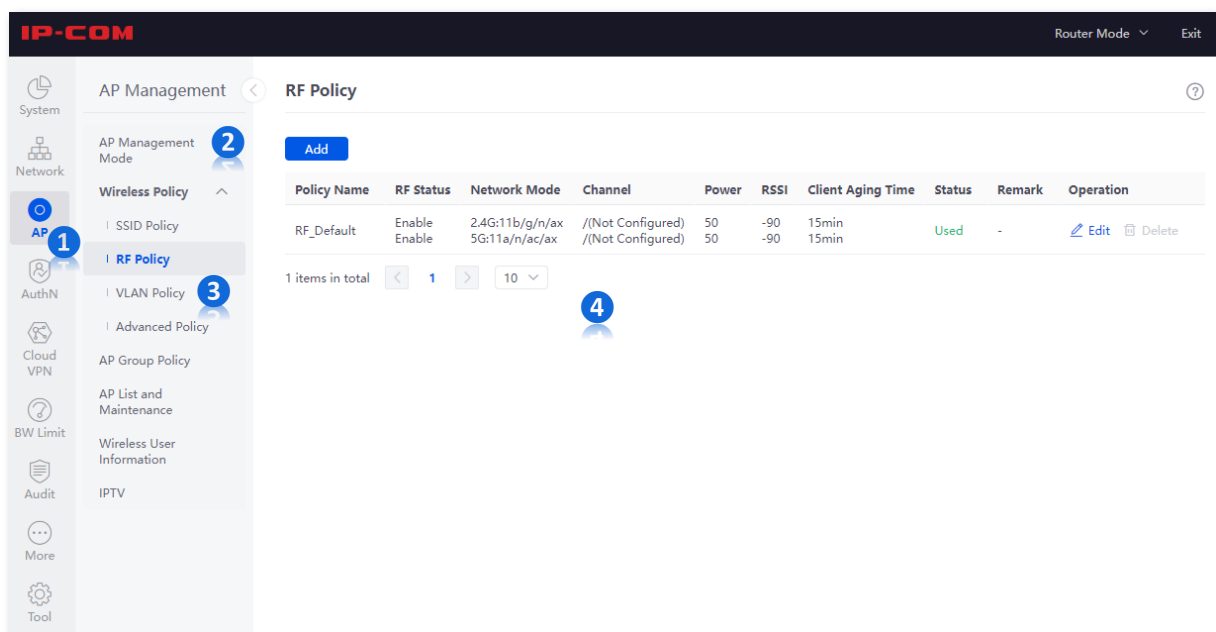







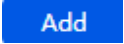

Features and parameters in gray indicate that they are not available or cannot be changed under the current condition.

NO.	Name	Description
1	Level-1 navigation bar	
2	Level-2 navigation bar	Used to display the function menu of the router. Users can select functions in the navigation bars and the configuration appears in the configuration area.
3	Level-3 navigation bar	
4	Configuration area	Used to view and modify the configuration.

## 3.2 Common buttons

The following table describes the common buttons available on the web UI of the device.

Common buttons	Description
	Used to add new rules on the current page.
	Used to save the configuration on the current page and enable the configuration to take effect.
	Used to restore the original configuration without saving the configuration on the current page.
	Used to edit the rules, policies or information.
	Used to delete the rules on the current page.
	Used to view the help information for the current page.
	Used to view the help information of the corresponding setting.
	Used to customize the list parameters to be displayed, or restore the list parameters display to the default state.



# 4 System status

## 4.1 View network information

[Log in to the web UI of the router](#), and click **System** to enter the page.

In the **Network Info** module, you can quickly view the WAN port network status and connection duration of the router. For details, refer to [Check connection status](#).

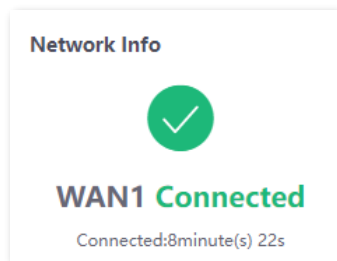

If an error message is displayed, you can click  to redirect to the [Internet Settings](#) page and check it. The following figure is for reference only.

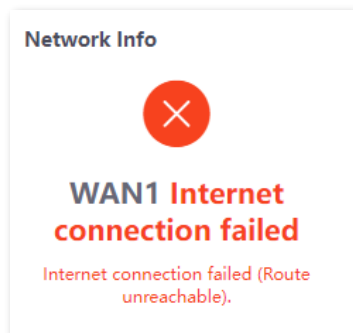

## 4.2 View system resource information

[Log in to the web UI of the router](#), and click **System** to enter the page.

In the **System Resource Information** module, you can view the system information of the router. The following figure is for reference only.

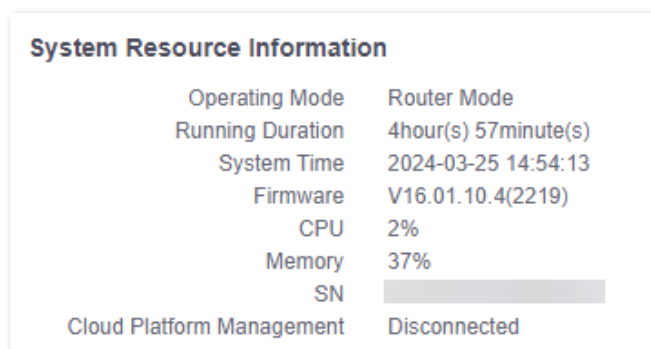

### Parameter description

Parameter	Description
Operating Mode	Specifies the current operating mode of the router.
Running Duration	Specifies the time during which this router is operating since the last reboot.
System Time	Specifies the current system time of the router.
Firmware	Specifies the current firmware version of the router.
CPU	Specifies the CPU usage of the router.
Memory	Specifies the memory usage of the router.
SN	Specifies the serial number of the router, which is a unique identifier of the router. It can generally be found on the label of the router.
Cloud Platform Management	Specifies whether the router is connected to the cloud platform.

## 4.3 View running quality monitoring

[Log in to the web UI of the router](#), and click **System** to enter the page.

In the **Running Quality Monitoring** module, you can view the abnormal logs of the router. A maximum of 10 latest logs will be displayed. For details, click **View Details** to redirect to [Network Monitoring Logs](#) page.

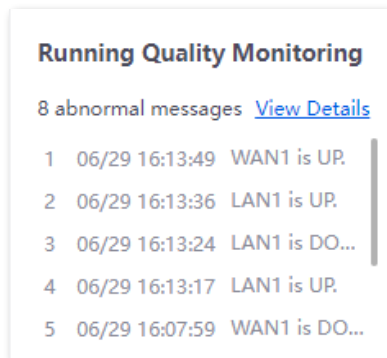

## 4.4 View statistics of terminals

[Log in to the web UI of the router](#), and click **System** to enter the page.

In the **Statistics of terminals** module, you can view the basic information of the number of users and sessions connected to the router, the number of online and offline APs managed by the router, the number of users currently connected to the 2.4 GHz and 5 GHz network.

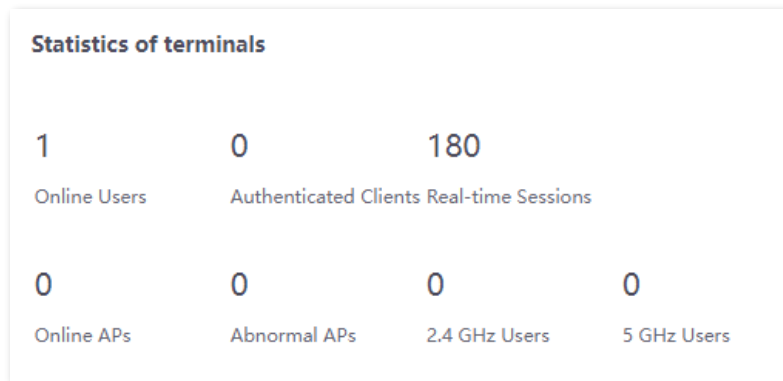

### Parameter description

Parameter	Description
Online Users	Specifies the total number of current online users.
Authenticated Clients	Specifies the number of online devices that have been authenticated and connected to the router.
Real-time Sessions	Specifies the number of concurrent connections of the router.
Online APs	Specifies the number of online APs. For details, refer to <a href="#">AP list and maintenance</a> .
Abnormal APs	Specifies the number of offline APs. For details, refer to <a href="#">AP list and maintenance</a> .
2.4 GHz Users	Specifies the number of users connected to the 2.4 GHz network. For details, refer to <a href="#">Wireless user information</a> .
5 GHz Users	Specifies the number of users connected to the 5 GHz network. For details, refer to <a href="#">Wireless user information</a> .



## 4.5 View port information

[Log in to the web UI of the router](#), and click **System** to enter the page.

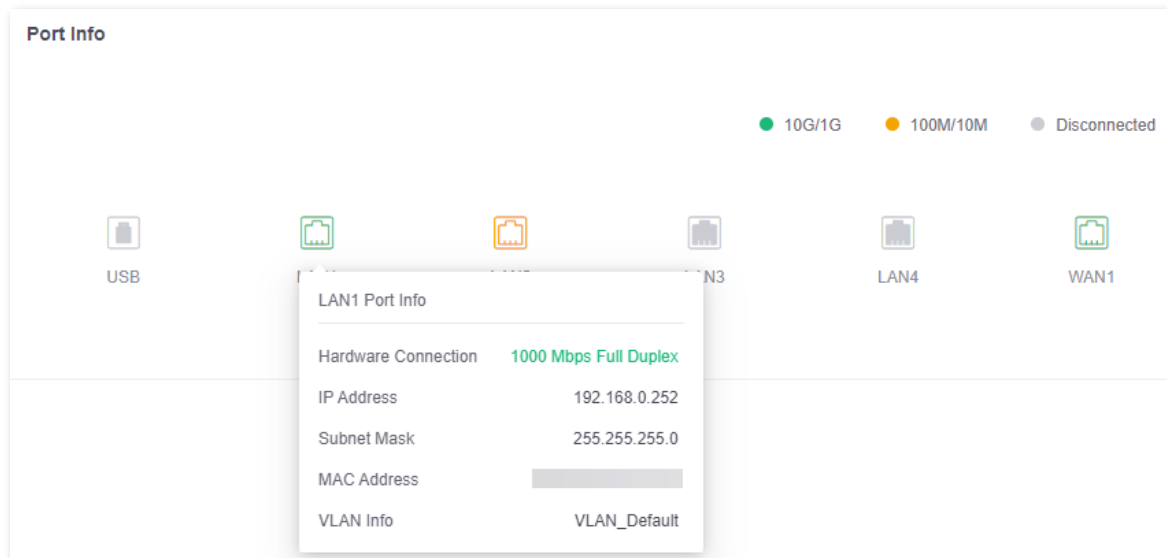
In the **Port Info** module, you can view the basic status of each port of the router. Hover the mouse over the port icon to view the physical connection status, IP address and other information of each port.



### Parameter description

Parameter	Description
Ports	<p>Specifies the roles and connection status of each port of the router. Only M30 has a USB port and supports USB devices insertion.</p> <p> : Green means connected, and the rate is 10 Gbps/1 Gbps.</p> <p> : Orange means connected, and the rate is 100 Mbps/10 Mbps.</p> <p> : Grey means disconnected.</p>
LAN Port Info	<p>Specifies the connection status of the LAN port.</p> <ul style="list-style-type: none"> <li><b>Connection not detected</b> in red indicates that the Ethernet cable is not properly connected.</li> <li><b>Connected</b> indicates that the Ethernet cable is properly connected and the rate is being negotiated.</li> </ul>
IP Address	Specifies the IPv4 address of the LAN port.
Subnet Mask	Specifies the subnet mask of the LAN port.
MAC Address	Specifies the MAC address of the LAN port.

Parameter	Description
VLAN Info	Specifies the VLAN of the LAN port.
WAN Port Info	Specifies the <a href="#">connection status</a> of the WAN port.

## 4.6 View WAN real-time rate (Router mode)

[Log in to the web UI of the router](#), and click **System** to enter the page.

In the **WAN Real-time Rate** module, you can view the upload and download rates of all WAN ports or a certain WAN port of the router.

Click the drop-down box next to **WAN Real-time Rate** to select a certain WAN port of the router.

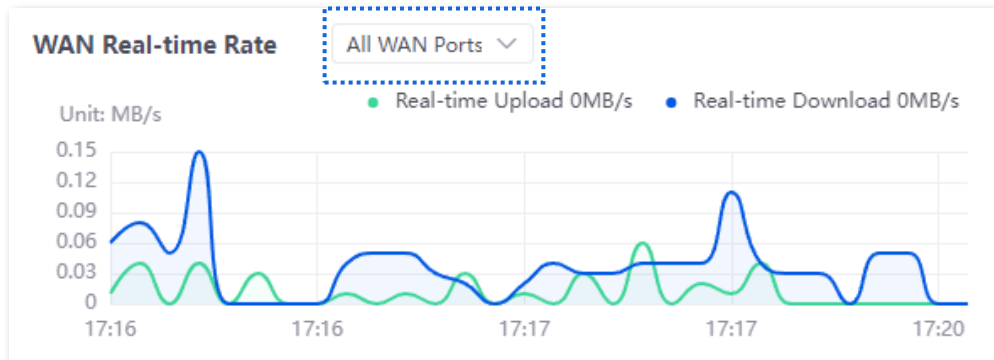

## 4.7 View number of online clients (Pure AC mode)

[Log in to the web UI of the router](#), and click **System** to enter the page.

In the **No. of Online Clients** module, you can view the real-time changes in the number of users connected to the AP's 2.4 GHz and 5 GHz network.

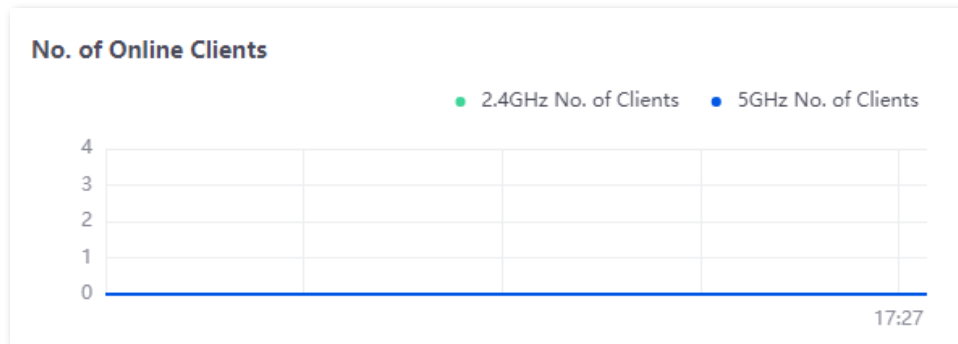



# 5 Network

## 5.1 Internet settings

Here, you can configure the internet access parameters of the WAN port of the router, so that multiple devices in the LAN can share the broadband service.

### 5.1.1 No. of WAN ports

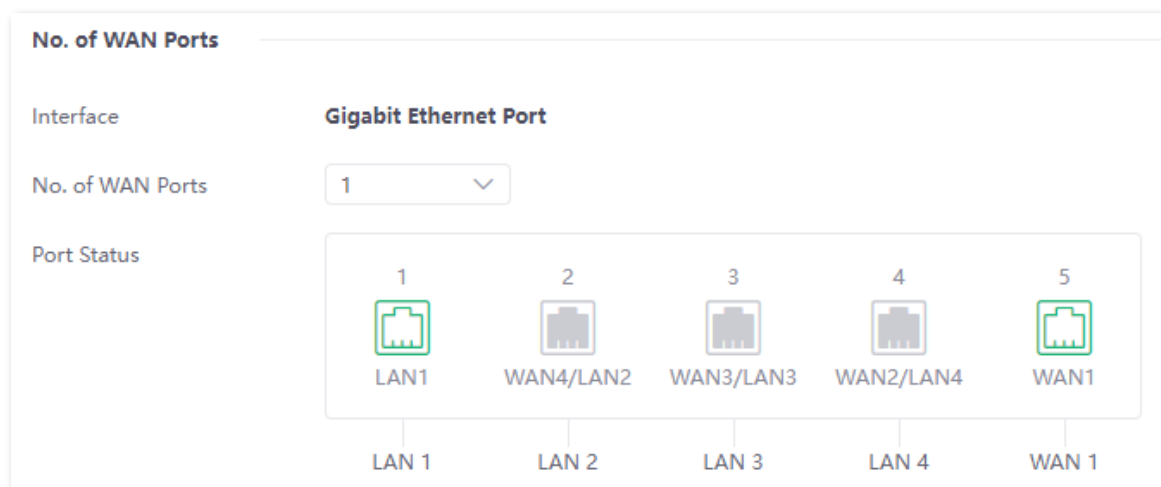

[Log in to the web UI of the router](#), and navigate to **Network > Internet Settings** to enter the page.

In the **No. of WAN Ports** module, you can view the rate type of the WAN port and set the number of WAN ports. You can also view the connection status and the properties of each Ethernet port. The following figure is for reference only.



#### Parameter description

Parameter	Description
Interface	Specifies the rate type of the port.
No. of WAN Ports	Specifies the number of WAN ports. The number of default WAN ports varies according to router models. You can change the WAN port number as required.

Parameter	Description
	Specifies the port type and the connection status.
Port Status	 : The port is connected properly.
	 : The port is disconnected or not connected properly.

## 5.1.2 Set the internet

[Log in to the web UI of the router](#), and navigate to **Network > Internet Settings** to enter the page.

In the **Connection Settings** module, you can set the internet parameters of the WAN port. Connection types of the router include [PPPoE](#), [Dynamic IP Address](#) and [Static IP Address](#).



- The number of default WAN ports varies according to router models. WAN1 is used as an example, and configurations for other WAN ports are similar.
- All internet parameters for accessing the internet are provided by your ISP. If you are not sure, contact your ISP for help.

### PPPoE

If the ISP provides you with a PPPoE user name and password, you can choose this connection type to access the internet.

#### Configuration procedure

1. [Log in to the web UI of the router](#), and navigate to **Network > Internet Settings**.
2. Set the **ISP Type**, which is **Normal** in this example.
3. Select **PPPoE** for **Connection Type**.
4. Enter the PPPoE user name and password provided by the ISP.
5. Click **Connect**.

The screenshot shows a 'Connection Settings' dialog box. It has the following fields and options:

- ISP Type: Normal (dropdown)
- Connection Type: PPPoE (dropdown)
- PPPoE User Name: [text input]
- PPPoE Password: [password input with eye icon]
- Server Name: [text input] Optional
- Service Name: [text input] Optional
- Primary DNS: [IP input] (Optional)
- Secondary DNS: [IP input] (Optional)



At the bottom, there are two buttons: 'Connect' (blue) and 'Disconnect' (white).

----End

Wait for a moment. You can view related internet information in the [Connection Status](#) module.

### Parameter description

Parameter	Description
ISP Type	<p>Specifies the type of your ISP, such as <b>Normal</b>, <b>Russia</b>, <b>Unifi</b>, <b>Maxis</b> and <b>Manual</b>. Parameters required for each option may differ.</p> <p>Refer to the following to choose your connection type:</p> <ul style="list-style-type: none"><li>- <b>Normal</b>: It specifies a common ISP type. Select this option by default.</li><li>- <b>Unifi</b> and <b>Maxis</b>: Select these options when your ISP provides specific parameters such as Internet VLAN ID and IPTV VLAN ID. Internet VLAN ID and IPTV VLAN ID cannot be changed.</li><li>- <b>Russia</b>: It is the access type provided by Russia. Select this option when your ISP provides dual access information.</li><li>- <b>Manual</b>: Select this option when your ISP provides VLAN ID information. You can configure the Internet VLAN ID and IPTV VLAN ID as required.</li></ul> <p>If you are not sure, contact your ISP for help.</p>

Parameter	Description
Connection Type	<p>Specifies how your router connects to the internet, including:</p> <ul style="list-style-type: none"> <li>- <b>PPPoE:</b> Select this type if you access the internet using the PPPoE user name and PPPoE password.</li> <li>- <b>Dynamic IP Address:</b> Select this type if you can access the internet by simply plugging in an Ethernet cable.</li> <li>- <b>Static IP Address:</b> Select this type if you want to access the internet using fixed IP information.</li> <li>- <b>Russia PPPoE, Russia PPTP and Russia L2TP:</b> They are available only when you set <b>ISP Type</b> to <b>Russia</b>. The specific configuration is completed according to the requirements of the ISP.</li> </ul>
PPPoE User name	Specify the PPPoE user name and password provided by the ISP.
PPPoE Password	
Server Name	<p>Specifies the name of the PPPoE server, also called the AC name. Used by the router to verify the validity of the PPPoE server.</p> <p>The <b>Server Name</b> is optional.</p> <p> <b>Note</b></p> <p>To avoid dialing failures, do not set this parameter if your ISP does not provide the server name.</p>
Service Name	<p>Specifies the name of the PPPoE service. Used by the PPPoE server to verify the validity of the router.</p> <p>The <b>Service Name</b> is optional.</p> <p> <b>Note</b></p> <p>To avoid dialing failures, do not set this parameter if your ISP does not provide the service name.</p>
Primary DNS	<p>Manually enter primary or secondary DNS servers.</p> <p>When the DNS server obtained automatically cannot resolve the URL normally, you can manually enter the correct primary or secondary DNS server here.</p>
Secondary DNS	The <b>Primary DNS</b> and <b>Secondary DNS</b> are optional.

## Dynamic IP address

If the ISP dynamically assigns you the IP address information, you can choose this connection type to access the internet.

### Configuration procedure

1. [Log in to the web UI of the router](#), and navigate to **Network > Internet Settings**.
2. Set the **ISP Type**, which is **Normal** in this example.
3. Select **Dynamic IP Address** for **Connection Type**.
4. Click **Connect**.

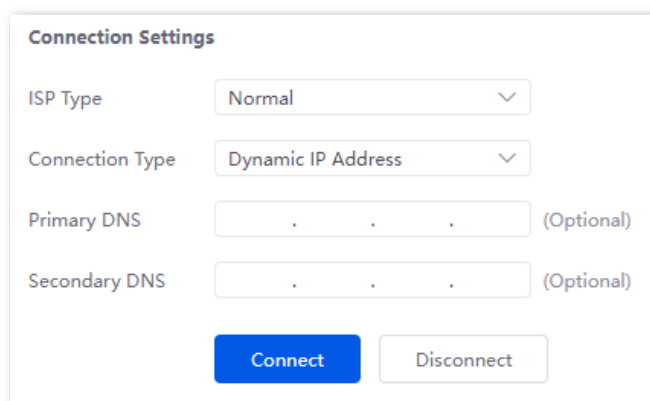

**Connection Settings**

ISP Type: Normal

Connection Type: Dynamic IP Address

Primary DNS: . . . (Optional)

Secondary DNS: . . . (Optional)

Connect Disconnect

----End

Wait for a moment. You can view related internet information in the [Connection Status](#) module.

### Parameter description

Parameter	Description
ISP Type	<p>Specifies the type of your ISP, such as <b>Normal</b>, <b>Russia</b>, <b>Unifi</b>, <b>Maxis</b> and <b>Manual</b>. Parameters required for each option may differ.</p> <p>Refer to the following to choose your connection type:</p> <ul style="list-style-type: none"><li>- <b>Normal</b>: It specifies a common ISP type. Select this option by default.</li><li>- <b>Unifi</b> and <b>Maxis</b>: Select these options when your ISP provides specific parameters such as Internet VLAN ID and IPTV VLAN ID. Internet VLAN ID and IPTV VLAN ID cannot be changed.</li><li>- <b>Russia</b>: It is the access type provided by Russia. Select this option when your ISP provides dual access information.</li><li>- <b>Manual</b>: Select this option when your ISP provides VLAN ID information. You can configure the Internet VLAN ID and IPTV VLAN ID as required.</li></ul> <p>If you are not sure, contact your ISP for help.</p>

Parameter	Description
Connection Type	<p>Specifies how your router connects to the internet, including:</p> <ul style="list-style-type: none"><li>– <b>PPPoE:</b> Select this type if you access the internet using the PPPoE user name and PPPoE password.</li><li>– <b>Dynamic IP Address:</b> Select this type if you can access the internet by simply plugging in an Ethernet cable.</li><li>– <b>Static IP Address:</b> Select this type if you want to access the internet using fixed IP information.</li><li>– <b>Russia PPPoE, Russia PPTP and Russia L2TP:</b> They are available only when you set <b>ISP Type</b> to <b>Russia</b>. The specific configuration is completed according to the requirements of the ISP.</li></ul>
Primary DNS	<p>Manually enter primary or secondary DNS servers.</p>
Secondary DNS	<p>When the DNS server obtained automatically cannot resolve the URL normally, you can manually enter the correct primary or secondary DNS server here.</p> <p>The <b>Primary DNS</b> and <b>Secondary DNS</b> are optional.</p>

## Static IP address

If the ISP provides you with the fixed IP address, subnet mask, default gateway and DNS server information, you can choose this connection type to access the internet.

### Configuration procedure

1. [Log in to the web UI of the router](#), and navigate to **Network > Internet Settings**.
2. Set the **ISP Type**, which is **Normal** in this example.
3. Select **Static IP Address** for **Connection Type**.
4. Enter the **IP Address**, **Subnet Mask**, **Default Gateway**, **Primary DNS** and **Secondary DNS** provided by the ISP.
5. Click **Connect**.

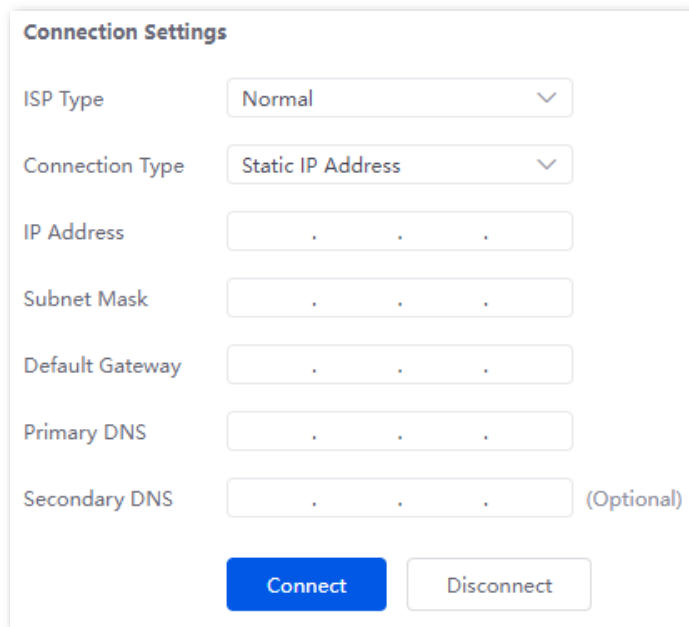

**Connection Settings**

ISP Type: Normal

Connection Type: Static IP Address

IP Address: . . .

Subnet Mask: . . .

Default Gateway: . . .

Primary DNS: . . .

Secondary DNS: . . . (Optional)

**Connect**    Disconnect

----End

Wait for a moment. You can view related internet information in the [Connection Status](#) module.

## Parameter description

Parameter	Description
ISP Type	<p>Specifies the type of your ISP, such as <b>Normal</b>, <b>Russia</b>, <b>Unifi</b>, <b>Maxis</b> and <b>Manual</b>. Parameters required for each option may differ.</p> <p>Refer to the following to choose your connection type:</p> <ul style="list-style-type: none"> <li>- <b>Normal</b>: It specifies a common ISP type. Select this option by default.</li> <li>- <b>Unifi</b> and <b>Maxis</b>: Select these options when your ISP provides specific parameters such as Internet VLAN ID and IPTV VLAN ID. Internet VLAN ID and IPTV VLAN ID cannot be changed.</li> <li>- <b>Russia</b>: It is the access type provided by Russia. Select this option when your ISP provides dual access information.</li> <li>- <b>Manual</b>: Select this option when your ISP provides VLAN ID information. You can configure the Internet VLAN ID and IPTV VLAN ID as required.</li> </ul> <p>If you are not sure, contact your ISP for help.</p>
Connection Type	<p>Specifies how your router connects to the internet, including:</p> <ul style="list-style-type: none"> <li>- <b>PPPoE</b>: Select this type if you access the internet using the PPPoE user name and PPPoE password.</li> <li>- <b>Dynamic IP Address</b>: Select this type if you can access the internet by simply plugging in an Ethernet cable.</li> <li>- <b>Static IP Address</b>: Select this type if you want to access the internet using fixed IP information.</li> <li>- <b>Russia PPPoE</b>, <b>Russia PPTP</b> and <b>Russia L2TP</b>: They are available only when you set <b>ISP Type</b> to <b>Russia</b>. The specific configuration is completed according to the requirements of the ISP.</li> </ul>
IP Address	
Subnet Mask	Enter the <b>IP Address</b> , <b>Subnet Mask</b> , <b>Default Gateway</b> , <b>Primary DNS</b> and <b>Secondary DNS</b> provided by the ISP.
Default Gateway	 <b>Tip</b>
Primary DNS	If the ISP only provides one DNS address, the <b>Secondary DNS</b> is not required.
Secondary DNS	

### 5.1.3 Check connection status

[Log in to the web UI of the router](#), and navigate to **Network > Internet Settings** to enter the page.

In the **Connection Status** module, you can view the network status of the corresponding WAN port IPv4, including the Ethernet port connection rate and duplex mode, connection status, duration and IP address. The following figure is for reference only.



Connection Status	
Hardware Connection	100 Mbps Full Duplex
Status	Connected
Duration	40minute(s) 59s
IP Address	192.168.99.42
Subnet Mask	255.255.255.0
Default Gateway	192.168.99.1
Primary DNS	192.168.108.110
Secondary DNS	192.168.108.108

### Parameter description

Parameter	Description
Hardware Connection	<p>Specifies the negotiation rate and duplex mode of the WAN port.</p> <p>If the display is abnormal, you can troubleshoot based on the information on the page and the current environment.</p>
Status	<p>Specifies the connection status of the WAN port of the router.</p> <ul style="list-style-type: none"> <li>- <b>Connected:</b> The WAN port of the router has been plugged into the Ethernet cable, and the IPv4 address information has been obtained.</li> <li>- <b>Connecting...:</b> The router is connecting to the upstream network device.</li> <li>- <b>Disconnected:</b> If it is not connected or fails to connect, check the Ethernet cable connection status and internet settings, or contact the corresponding ISP for help.</li> </ul> <p>If other status information is displayed, take corresponding measures according to the network status prompt information.</p>
Duration	Specifies the latest duration of the WAN port access to the network.
IP Address	Specifies the IPv4 address of the WAN port.
Subnet Mask	Specifies the subnet mask of the WAN port.
Default Gateway	Specifies the IPv4 gateway address of the WAN port.
Primary DNS	Specify the primary or secondary DNS server address of the WAN port.
Secondary DNS	

## 5.2 LAN settings

[Log in to the web UI of the router](#), and navigate to **Network > LAN Settings** to enter the page. You can view the router's LAN port connection status and configuration information on this page. You can also set the IPv4 address information of the router's **VLAN\_Default**.

**LAN Port Status**

No. of LAN Ports 4

Port Status

1  
  
LAN1

2  
  
WAN4/LAN2

3  
  
WAN3/LAN3

4  
  
WAN2/LAN4

5  
  
WAN1

LAN 1
LAN 2
LAN 3
LAN 4
WAN 1

---

**Configure IP Address**

IP Address



Subnet Mask

MAC Address

Default VLAN Info Management VLAN: 1

[Save](#)

### Parameter description

Parameter	Description
No. of LAN Ports	Specifies the number of current LAN ports.
LAN Port Status	Specifies the connection status of the port.
Port Status	 : The port is connected properly.  : The port is disconnected or not connected properly.

Parameter	Description
IP Address	Specifies the IPv4 address of the <a href="#">VLAN Default</a> . Devices connected to the <b>VLAN_Default</b> can access the IPv4 address to log in to the web UI of the router through the <b>http</b> (default) or <b>https</b> protocol. The default address is <b>192.168.0.252</b> .
Configure IP Address	 Tip
	You need to disable the network adapter of the computer first and then enable the network adapter to obtain the IP address again.
	Subnet Mask Specifies the subnet mask of the <a href="#">VLAN Default</a> .
	MAC Address Specifies the MAC address of the <a href="#">VLAN Default</a> .
Default VLAN Info	Specifies the VLAN ID of the <a href="#">VLAN Default</a> of the router.

## 5.3 LAN configuration information

[Log in to the web UI of the router](#), and navigate to **Network > LAN Configuration Info** to enter the page. On this page, you can view the configuration of the LAN port.

LAN Configuration Info <span style="float: right;">?</span>			
Interface	Hardware Connection	DHCP Configuration Info	VLAN Configuration Info
LAN1	1000 Mbps Full Duplex	192.168.0.2-192.168.0.254 10.10.96.2-10.10.127.254	1
LAN2	100 Mbps Full Duplex	192.168.0.2-192.168.0.254 10.10.96.2-10.10.127.254	1
LAN3	100 Mbps Full Duplex	192.168.0.2-192.168.0.254 10.10.96.2-10.10.127.254	1
LAN4	Connection not detected	192.168.0.2-192.168.0.254 10.10.96.2-10.10.127.254	1

### Parameter description

Parameter	Description
Interface	Specifies the LAN port of the router.
Hardware Connection	<p>Specifies the connection status of the LAN port.</p> <ul style="list-style-type: none"> <li>- <b>Connection not detected</b> in red indicates that the Ethernet cable is not properly connected.</li> <li>- The description in green indicates that the Ethernet cable is properly connected.</li> <li>- <b>Obtaining</b> in yellow indicates that the Ethernet cable is connected and the rate is being negotiated.</li> </ul>
DHCP Configuration Info	<p>Specifies the IP address range that the DHCP server of the LAN port allocates to its clients.</p> <p>You can modify the IP address range in <b>Network &gt; DHCP Settings &gt; <a href="#">DHCP Server</a></b>.</p>
VLAN Configuration Info	Specifies the VLAN to which the LAN port belongs.

## 5.4 VLAN settings

### 5.4.1 Overview

VLAN, abbreviated for Virtual Local Area Network, is a technology that divides LAN devices into different network segments logically rather than physically to create virtual work groups. It is used to divide the workstations in the switch-formed network into logical groups among which the broadcast is isolated. Workstations in a group belong to the same VLAN and can communicate like they are connected to the same network segment no matter where they physically are. However, due to the isolation of broadcast packets, the VLAN cannot communicate with each other and packets must be forwarded by a router or other layer 3 packet forwarding devices.

Compared with the traditional Ethernet, VLAN has the following advantages:

- Control the range of broadcast domain: Broadcast messages in the LAN are restricted in a VLAN, which saves bandwidth and improves network processing capability.
- Enhance the security of the LAN: Because messages are isolated in the data link layer by the broadcast domain divided by VLAN, the host in each VLAN cannot directly communicate with each other and messages have to be forwarded by a router or other layer 3 network devices.
- Create virtual work groups freely: Users can create virtual work groups irrespective of physical network range with VLAN. Users can still access the network without having to change network configurations as long as they remain within the virtual work group even if his or her physical location changes.

[Log in to the web UI of the router](#), and navigate to **Network > VLAN Settings** to enter the page. On this page, you can configure VLAN rules.



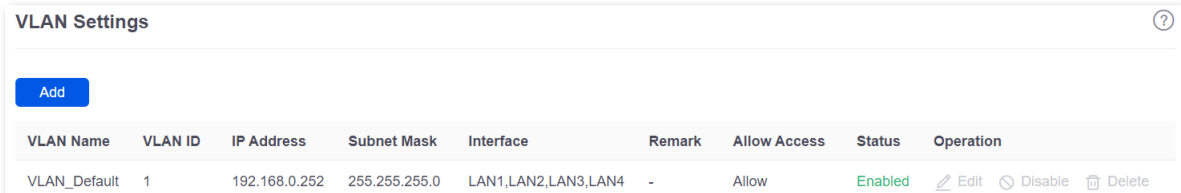

By default, the router has created a VLAN named **VLAN\_Default**, and its VLAN ID is **1**, which cannot be deleted. If VLAN=1, there is no VLAN information, only the data of the LAN port without VLAN is processed. If VLAN≠1, only the data of the LAN port with VLAN is processed.



VLAN Name	VLAN ID	IP Address	Subnet Mask	Interface	Remark	Allow Access	Status	Operation
VLAN_Default	1	192.168.0.252	255.255.255.0	LAN1,LAN2,LAN3,LAN4	-	Allow	Enabled	Edit Disable Delete

#### Parameter description

Parameter	Description
VLAN Name	Specifies the name of each added VLAN ID.

Parameter	Description
VLAN ID	<p>Specifies the identifier of virtual local area network (VLAN) and is used to separate subordinate LANs inside a LAN. Each ID represents a LAN.</p> <p> <b>Tip</b></p> <p>If the VLAN ID is <b>1</b>, it means that there is no VLAN information, and only data without Tag is processed.</p>
IP Address	Specifies the VLAN IP address. Devices connecting to the port can log in to the web UI of the router using the IP address.
Subnet Mask	Specifies the subnet mask of the VLAN.
Interface	Specifies the physical ports that belong to the VLAN. Select at least one port.
Remark	Specifies the introduction of the VLAN.
Allow Access	<p>Specifies whether clients from other VLANs can access services of this VLAN.</p> <ul style="list-style-type: none"> <li>- <b>Allow</b> indicates that clients from other VLANs can access services of this VLAN.</li> <li>- <b>Forbid</b> indicates that clients from other VLANs cannot access the services of this VLAN.</li> </ul>
Status	Specifies the current status of the VLAN, including <b>Enabled</b> and <b>Disabled</b> .
Operation	<p>Used to edit, enable, disable or delete the VLAN.</p> <ul style="list-style-type: none"> <li> <b>Edit</b>: Used to modify the VLAN.</li> <li> <b>Enable</b>: Used to enable the VLAN.</li> <li> <b>Disable</b>: Used to disable the VLAN.</li> <li> <b>Delete</b>: Used to delete the VLAN.</li> </ul>

## 5.4.2 Example of configuring the VLAN

### Networking requirements

An enterprise uses the enterprise router and fat AP to set up a network. The enterprise has the following requirements:

Visitors, departments and staff are required to access networks that are isolated from each other and have different network permissions.

- Guests can only access the internet and are isolated from other networks when accessing the wireless network.
- Staff of the Financial Department support access to wired and wireless networks, which can only access the intranet and are isolated from other networks.
- Staff of the R&D Department support access to wired networks and wireless networks, which can only access the intranet and are isolated from other networks.

### Solution

- Successfully manage the AP on the router, and deliver different wireless policies to the AP.
- Configure the SSID policy for guest connection. The SSID is **internet**. The wireless password is **UmXmL9UK**, and the VLAN ID is **20**.
- Configure the SSID policy for staff of the Financial Department. The SSID is **Financial**. The wireless password is **CetTLb8T**, and the VLAN ID is **30**.
- Configure the SSID policy for staff of the R&D Department. The SSID is **R&D**. The wireless password is **ZeFtub6m**, and the VLAN ID is **40**.
- Divide the wired network connected by the staff of the Financial Department into **VLAN30**.
- Divide the wired network connected by the staff of the R&D Department into **VLAN40**.
- Configure VLAN forwarding rules on the switch.
- Configure VLAN forwarding rules on the router and the internal server.

The application scenarios are as follows.

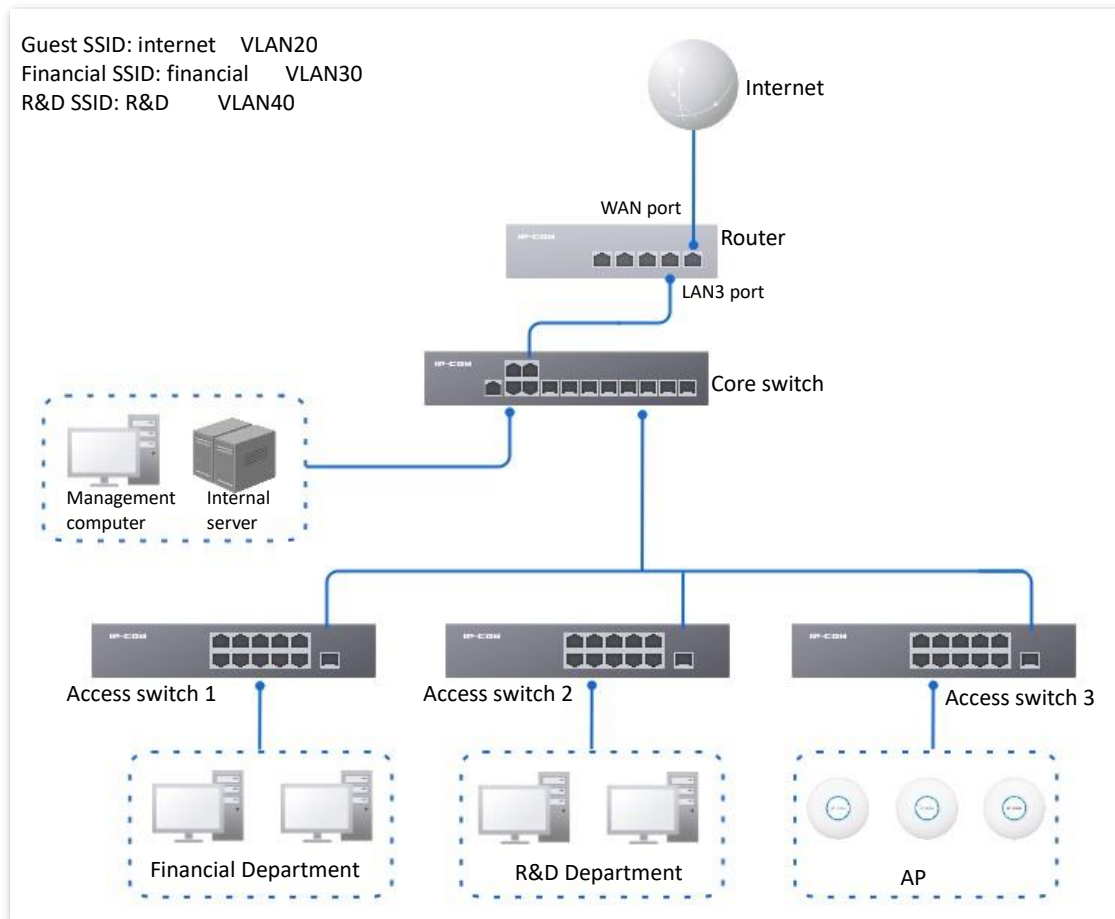

## Configuration procedure

Configure the router

Configure the core switch

Configure the internal server

### I. Configure the router.

1. [Log in to the web UI of the router.](#)
2. Manage the AP (Skip if performed).
  - 1) Navigate to **AP > AP Management Mode**.
  - 2) Enable the **AP Management Mode** and **Configuration Auto Delivery** function.
  - 3) Click **Add** to add the DHCP policy for the management port. By default, the system has created a DHCP policy for the management port. The following figure is for reference only.



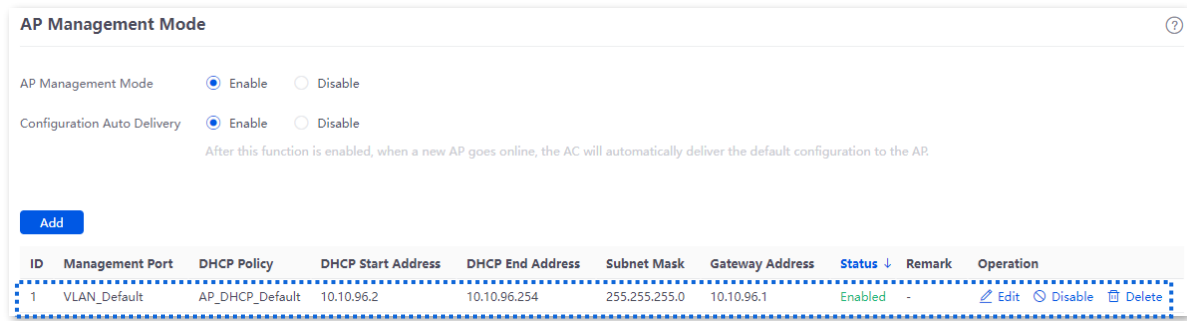

Navigate to **AP > AP List and Maintenance**, you can view whether the router successfully manages the AP.

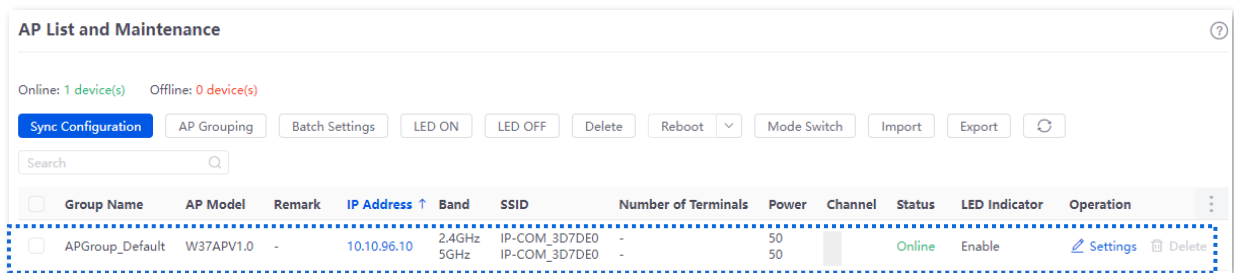

**3. Add the VLAN and configure the DHCP server.**

Examples of VLAN parameters are shown in the table below.

VLAN Name	VLAN ID	IP Address/Network Segment	Interface
Guest	20	192.168.20.1/24	LAN3

Examples of DHCP server parameters for the VLAN are shown in the following table.

Policy Name	Application Interface	DHCP Type	DHCP Configuration
Guest	<a href="#">Guest</a>	User DHCP	IP Address Pool: 192.168.20.100 to 192.168.20.200 Subnet Mask: 255.255.255.0 Gateway: 192.168.20.1 Primary DNS: 192.168.20.1
Guest1	<a href="#">Guest</a>	AP DHCP	IP Address Pool: 10.10.20.100 to 10.10.20.200 Subnet Mask: 255.255.255.0 Gateway: 10.10.20.1 Primary DNS: 10.10.20.1

**1) Add the VLAN.**

Navigate to **Network > VLAN Settings**, click **Add** to configure related parameters of the VLAN, and click **Save**.

VLAN Name	VLAN ID	IP Address	Subnet Mask	Interface	Remark	Allow Access	Status	Operation
VLAN_Default	1	192.168.0.252	255.255.255.0	LAN1,LAN2,LAN3,LAN4	-	Allow	Enabled	<a href="#">Edit</a> <a href="#">Disable</a> <a href="#">Delete</a>
Guest	20	192.168.20.1	255.255.255.0	LAN3	-	Allow	Enabled	<a href="#">Edit</a> <a href="#">Disable</a> <a href="#">Delete</a>

2) Configure the DHCP server for the VLAN.

Navigate to **Network > DHCP Settings > DHCP Server**, click **Add** to configure related parameters of the user DHCP server and AP DHCP server for the VLAN Guest, and click **Save**.

Policy Name	DHCP Type	Interface	Client Address	Subnet Mask	Gateway	Primary DNS	Lease	Status	Remark	Operation
User_DHCP_Default	User DHCP	VLAN_Default	192.168.0.2-192.168.0.254	255.255.255.0	192.168.0.252	192.168.0.252	30min	Enabled	-	<a href="#">Edit</a> <a href="#">Disable</a> <a href="#">Delete</a>
AP_DHCP_Default	AP DHCP	VLAN_Default	10.10.96.2-10.10.96.254	255.255.255.0	10.10.96.1	10.10.96.1	30min	Enabled	-	<a href="#">Edit</a> <a href="#">Disable</a> <a href="#">Delete</a>
Guest	User DHCP	Guest	192.168.20.100-192.168.20.200	255.255.255.0	192.168.20.1	192.168.20.1	30min	Enabled	-	<a href="#">Edit</a> <a href="#">Disable</a> <a href="#">Delete</a>
Guest1	AP DHCP	Guest	10.10.20.100-10.10.20.200	255.255.255.0	10.10.20.1	10.10.20.1	30min	Enabled	-	<a href="#">Edit</a> <a href="#">Disable</a> <a href="#">Delete</a>

4. Deliver the AP DHCP policy to the Guest VLAN interface.

- 1) Navigate to **AP > AP Management Mode**.
- 2) Click **Add** to add the AP DHCP policy for the LAN3 port.

AP Management Mode:  Enable  Disable

Configuration Auto Delivery:  Enable  Disable

After this function is enabled, when a new AP goes online, the AC will automatically deliver the default configuration to the AP.

ID	Management Port	DHCP Policy	DHCP Start Address	DHCP End Address	Subnet Mask	Gateway Address	Status	Remark	Operation
1	Guest	Guest1	10.10.20.100	10.10.20.200	255.255.255.0	10.10.20.1	Enabled	-	<a href="#">Edit</a> <a href="#">Disable</a> <a href="#">Delete</a>
2	VLAN_Default	AP_DHCP_Default	10.10.96.2	10.10.96.254	255.255.255.0	10.10.96.1	Enabled	-	<a href="#">Edit</a> <a href="#">Disable</a> <a href="#">Delete</a>

Navigate to **AP > AP List and Maintenance**, you can view that the IP address of the AP connected to the LAN3 port of the router belongs to the client address segment of the AP DHCP policy of the Guest VLAN.

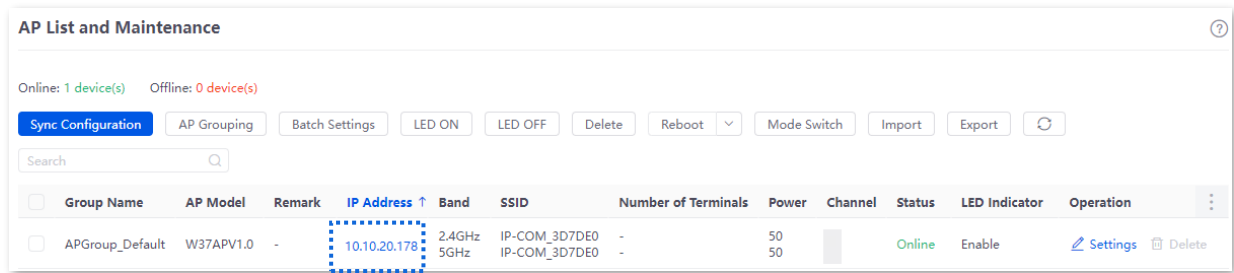

## 5. Configure the AP policy.

The following table provides examples of AP policy parameters. Retain default values for other parameters that are not mentioned.

SSID Policy	RF Policy	VLAN Policy	AP Group Policy
Policy Name: Guest SSID SSID: internet Security Mode/Encryption: WPA2-PSK/AES Password: UmXmL9UK VLAN ID: 20 Maximum Number of Clients: 40			Policy Name: Enterprise No. of SSIDs: 3 2.4G/5G SSID1 Policy: <a href="#">Guest SSID</a> 2.4G/5G SSID2 Policy: <a href="#">Financial SSID</a> 2.4G/5G SSID3 Policy: <a href="#">R&amp;D SSID</a> RF Policy: RF_Default VLAN Policy: AP VLAN
Policy Name: Financial SSID SSID: Financial Security Mode/Encryption: WPA2-PSK/AES Password: CetTLb8T VLAN ID: 30 Maximum Number of Clients: 40	RF_Default	Policy Name: AP VLAN AP VLAN: Enabled Trunk port: LAN0	
Policy Name: R&D SSID SSID: R&D Security Mode/Encryption: WPA2-PSK/AES Password: ZeFtub6m VLAN ID: 40 Maximum Number of Clients: 40			

### 1) Configure the SSID policy.

Navigate to **AP > Wireless Policy > SSID Policy**, click **Add** to configure related parameters of the SSID policy, and click **Save**.



The maximum number of clients supported by the AP is 128. If multiple SSID policies need to be delivered to the same AP, you should plan the maximum number of clients appropriately to ensure that the sum of the maximum number of clients for each SSID policy does not exceed 128.

Policy Name	SSID	Guest Network	Max. No. of Clients	Security Mode	Password	Hide SSID	Client Isolation	VLAN ID	Schedule Disable	Status	Remark	Operation
SSID1_Default	IP-COM_3D7DE0	Disable	48	None	-	Disable	Disable	1000	Disable	Used	-	<a href="#">Edit</a> <a href="#">Delete</a>
Guest SSID	internet	Disable	40	WPA2-PSK	UmXmL9UK	Disable	Disable	20	Disable	Not in Use	-	<a href="#">Edit</a> <a href="#">Delete</a>
Financial SSID	Financial	Disable	40	WPA2-PSK	CeTLb8T	Disable	Disable	30	Disable	Not in Use	-	<a href="#">Edit</a> <a href="#">Delete</a>
R&D SSID	R&D	Disable	40	WPA2-PSK	ZeFlub6m	Disable	Disable	40	Disable	Not in Use	-	<a href="#">Edit</a> <a href="#">Delete</a>

## 2) Configure VLAN policy.

Navigate to **AP > Wireless Policy > VLAN Policy**, click **Add**, enable the **AP VLAN** function and set **Trunk Port** to **LAN0**, and click **Save**.

Policy Name	AP VLAN	PVID	Management VLAN	Trunk Port	LAN Port	Status	Remark	Operation
AP VLAN	Enable	1	1	LAN0	LAN1:1	Not in Use	-	<a href="#">Edit</a> <a href="#">Delete</a>

## 3) Configure the AP group policy.

Navigate to **AP > AP Group Policy**, click **Add** to configure related parameters of the AP group policy, and click **Save**.

Group Name	SSID Policy	Band	RF Policy	VLAN Policy	Maintenance Policy	Alarm Policy	Password Policy	Remark	Operation
APGroup_Default	SSID1_Default SSID1_Default	2.4G 5G	RF_Default	-	-	-	-	-	<a href="#">Edit</a> <a href="#">Delete</a>
Enterprise	Guest SSID Financial SSID R&D SSID Guest SSID Financial SSID R&D SSID	2.4G 2.4G 2.4G 5G 5G 5G	RF_Default	AP VLAN	-	-	-	-	<a href="#">Edit</a> <a href="#">Delete</a>

## 6. Deliver the AP group policy.

- 1) Navigate to **AP > AP List and Maintenance**, select the AP to which the AP group policy is to be delivered, and click **AP Grouping**.

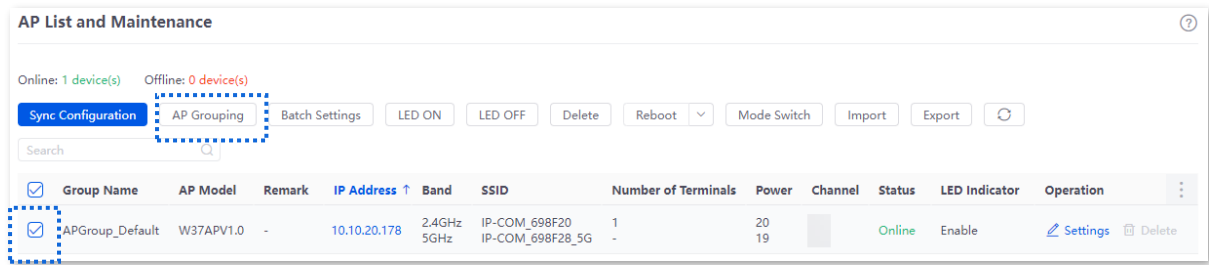

2) Select the AP group policy, and click **Save**. The following figure is for reference only.

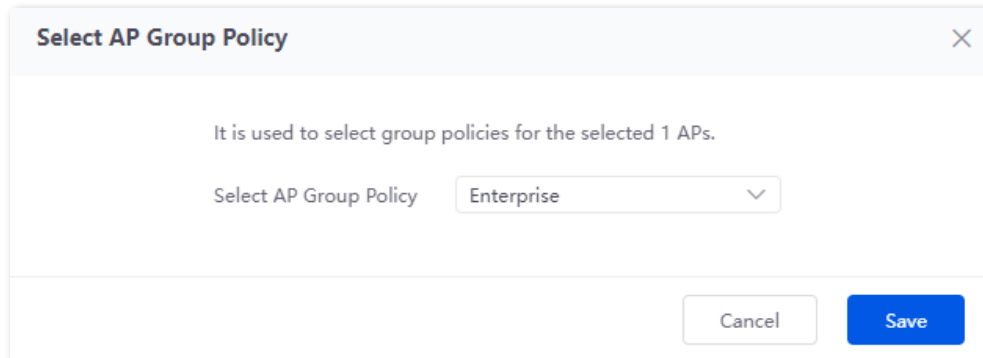

## II. Configure the core switch.

Divide the IEEE 802.1Q VLAN on the core switch as follows.

Port Connected to	VLAN ID (VLAN Allowed to Pass)	Port Property	PVID
Router	20	Access	1
Internal Server	30,40	Trunk	1
Switch1 (Financial Department)	30	Access	30
Switch2 (R&D Department)	40	Access	40
Switch3 (AP)	20,30,40	Trunk	1

Retain the default settings for other ports that are not mentioned. For details about how to configure the switch, see the user guide of the switch.

## III. Configure the internal server.

Add VLANs for ports connected to the switch and configure the DHCP server.

1. Add VLANs. The parameters in the following table are for reference only.

VLAN Name	VLAN ID	IP Address/Network Segment	Physical Port
Financial	30	192.168.30.1/24	LAN

VLAN Name	VLAN ID	IP Address/Network Segment	Physical Port
R&D	40	192.168.40.1/24	LAN

- Configure the user DHCP server for the VLAN. The parameters in the following table are for reference only.

Policy Name	User DHCP
Financial	Client Address: 192.168.30.100 - 192.168.30.200
	Subnet Mask: 255.255.255.0
	Gateway: 192.168.30.1
	Primary DNS: 192.168.30.1
R&D	Client Address: 192.168.40.100 - 192.168.40.200
	Subnet Mask: 255.255.255.0
	Gateway: 192.168.40.1
	Primary DNS: 192.168.40.1

- Set the VLAN of the port connected to the switch.

Port Connected to	VLAN ID (VLAN Allowed to Pass)	Port Property	PVID
Switch	30,40	Trunk	1

For details about how to configure the device, see the user guide of the corresponding device.

----End

## Verification

- When the guests connect to the wireless network **internet**, enter the wireless password **UmXmL9UK** to access the internet and be isolated from other networks.
- When the staff of the Financial Department connect to the wireless network **Financial**, enter the wireless password **CetTLb8T** to access the intranet and be isolated from other networks.
- When the staff of the R&D Department connect to the wireless network **R&D**, enter the wireless password **ZeFtub6m** to access the intranet and be isolated from other networks.
- When the staff of the Financial Department access the wired network, they can access the intranet and are isolated from other networks.
- When the staff of the R&D Department access the wired network, they can access the intranet and are isolated from other networks.

## 5.5 DHCP settings

### 5.5.1 Overview

When users have the following network requirements, the IP address configuration of the network device can be completed through the DHCP server.

- The network scale is large, and the workload of manually configuring network parameters for each network device is also large.
- The number of devices on the network is far greater than the number of IP addresses that can be used by the network, while the number of devices accessing the internet at the same time is less.
- Only a few hosts in the network need fixed IP addresses.

The router provides a DHCP server, which can automatically assign IP address information to DHCP clients.

### DHCP server

The IP address allocation mechanism is as follows:

- 1) When the router receives an IP address allocation request sent by the DHCP client, it queries the DHCP static allocation table according to the MAC address of the DHCP client. If the DHCP client is in the static allocation table, the corresponding IP address is assigned to the DHCP client. Otherwise, the router will take the next step.
- 2) The router identifies the DHCP client type (user or AP) and the VLAN to which it belongs from the request message, and then selects the type of DHCP server policy corresponding to the VLAN according to the identified information to assign an IP address.

### DHCP reservation

With the DHCP Reservation function, you can make the specified client always obtain the preset IP address, and avoid functions such as **Internet Speed Control** and **Port Mapping** that take effect based on the IP address from becoming invalid due to the change of the client IP address.



The DHCP Reservation function is mainly for users. If the AP is added to the DHCP reservation, the AP may obtain an IP address abnormally. To ensure the normal operation of the AP, do not add the AP to the DHCP reservation.

---

## 5.5.2 DHCP server

[Log in to the web UI of the router](#), and navigate to **Network > DHCP Settings > DHCP Server** to enter the page.

On this page, you can configure the DHCP server based on the VLAN. You can click  to select parameters to be displayed.

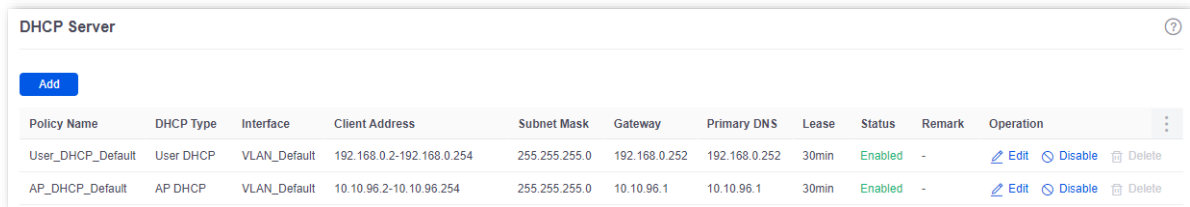

Policy Name	DHCP Type	Interface	Client Address	Subnet Mask	Gateway	Primary DNS	Lease	Status	Remark	Operation
User_DHCP_Default	User DHCP	VLAN_Default	192.168.0.2-192.168.0.254	255.255.255.0	192.168.0.252	192.168.0.252	30min	Enabled	-	<a href="#">Edit</a> <a href="#">Disable</a> <a href="#">Delete</a>
AP_DHCP_Default	AP DHCP	VLAN_Default	10.10.96.2-10.10.96.254	255.255.255.0	10.10.96.1	10.10.96.1	30min	Enabled	-	<a href="#">Edit</a> <a href="#">Disable</a> <a href="#">Delete</a>

By default, the router has created two DHCP server policies named **User\_DHCP\_Default** and **AP\_DHCP\_Default**. You can click **Add** to add a new DHCP server policy.

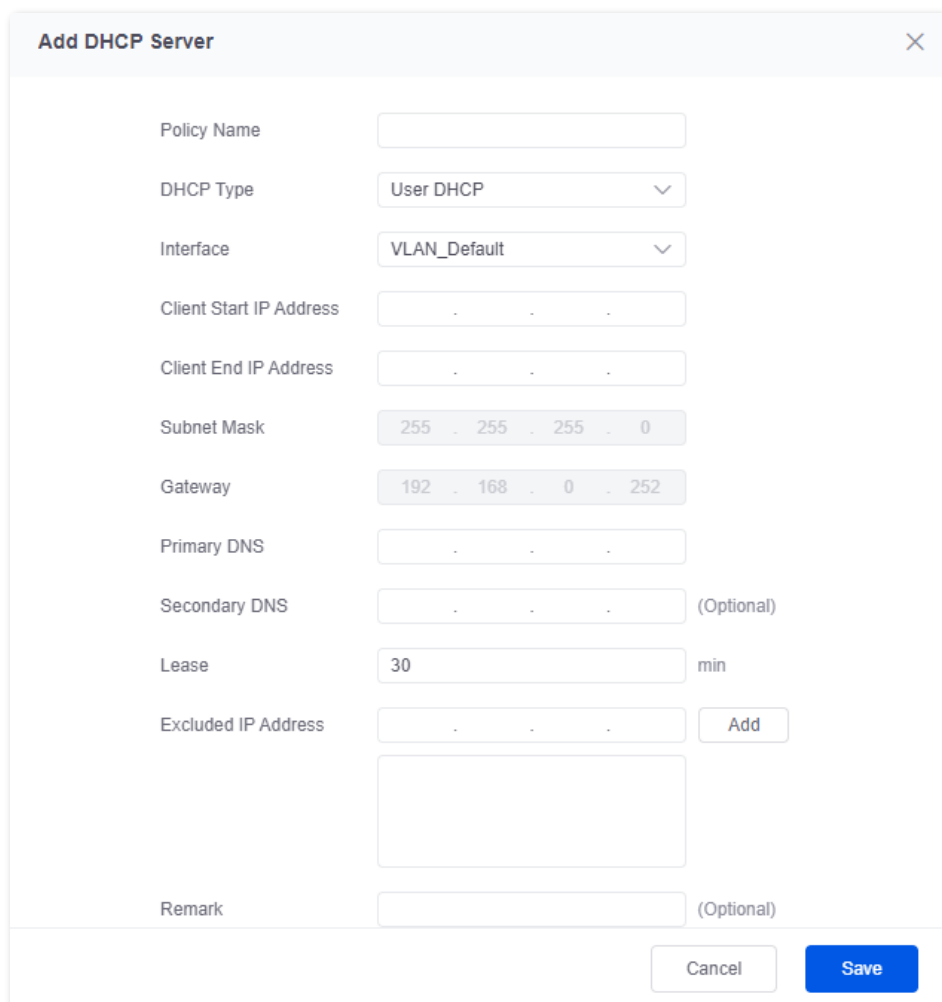

**Add DHCP Server**

Policy Name:

DHCP Type:

Interface:

Client Start IP Address:

Client End IP Address:

Subnet Mask:

Gateway:

Primary DNS:

Secondary DNS:    (Optional)

Lease:  min

Excluded IP Address:

Remark:  (Optional)



## Parameter description

Parameter	Description
Policy Name	Specifies the name of the DHCP policy.
DHCP Type	Specifies the DHCP type of the router. The router supports two types of DHCP: User DHCP and AP DHCP. <ul style="list-style-type: none"><li>– <b>User DHCP</b>: Used to assign IP address to clients.</li><li>– <b>AP DHCP</b>: Used to assign IP addresses to IP-COM APs.</li></ul>
Interface	Specifies the VLAN for which the DHCP server rule takes effect. You can configure the VLAN on the <a href="#">VLAN settings</a> page.
Client Address	Specifies the range of the DHCP address pool (range of IP addresses assigned by the DHCP server to its clients).
Client Start IP Address	Specifies the start IP address of the DHCP IP address pool.
Client End IP Address	Specifies the end IP address of the DHCP IP address pool.
Subnet Mask	Specifies the subnet mask that the DHCP server assigns to its clients.
Gateway	Specifies the gateway address that the DHCP server assigns to its clients.
Primary DNS	Specify the IP addresses of the primary or secondary DNS servers that are assigned to the device in the LAN by the DHCP server.
Secondary DNS	 <b>Note</b> For the LAN devices to access the internet properly, ensure that the primary or secondary DNS you entered is the correct IP address of the DNS server or proxy. Secondary DNS can be left blank.
Lease	Specifies the validity period of the IP address the DHCP server assigns to clients. <ul style="list-style-type: none"><li>– When the IP address of a client expires but the client is still connected to the router, auto-renewal happens and the client continues to occupy that IP address.</li><li>– If the client is disconnected (turned off, Ethernet cable disconnected or wireless network disconnected) from the router, the router will release the IP address and make it available for other clients in case they request IP address information as well.</li></ul>
Excluded IP Address	Specifies the IP address assigned to clients does not include the excluded address.
Status	Specifies the status of the DHCP server, including <b>Enabled</b> , <b>Disabled</b> and <b>Expired</b> .
Remark	Specifies the introduction of the DHCP server policy.

### 5.5.3 DHCP reservation

[Log in to the web UI of the router](#), and navigate to **Network > DHCP Settings > DHCP Reservation** to enter the page.

On this page, you can configure the DHCP static assignment rules and also import or export static IP address lists.

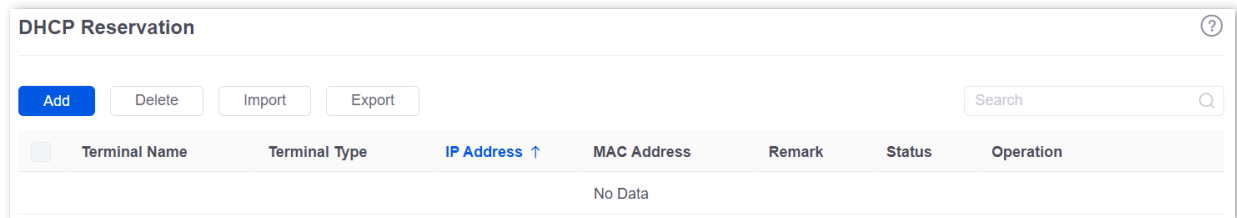

You can click **Add** to add a new DHCP reservation policy.

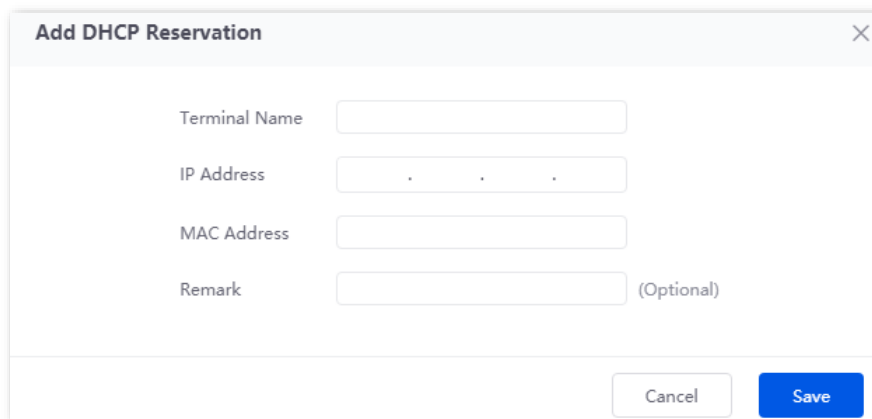

#### Parameter description

Parameter	Description
Terminal Name	Specifies the name of the client.
Terminal Type	Specifies the client types such as smartphone, PAD and PC. If the client type is not recognized, <b>Others</b> will be displayed.
IP Address	Specifies the fixed IP address to be assigned to the client.
MAC Address	Specifies the MAC address of the client. A MAC address can be specified in the following format: 00:23:24:E8:14:5A, 00-23-24-E8-14-5A or 002324E8145A.
Remark	Specifies the introduction of the assigned static IP address.
Status	Specifies the status of the DHCP reservation, including <b>Enabled</b> , <b>Disabled</b> and <b>Expired</b> .

Parameter	Description
Import	Used to import CSV files for adding DHCP static assignment rules.
Export	Used to export DHCP static assignment rules to your local computer as a CSV file.  Tip To modify the exported file, open the file as a txt file.

## 5.5.4 DHCP list

[Log in to the web UI of the router](#), and navigate to **Network > DHCP Settings > DHCP List** to enter the page.

On this page, you can perform the following operations on the client that obtains the IP address from this router:

- To view device information such as the client name and obtained IP address of the device.
- The clients with assigned IP addresses can be added to the static allocation list individually or in batches, so that the DHCP server always assigns the same IP address to the clients.

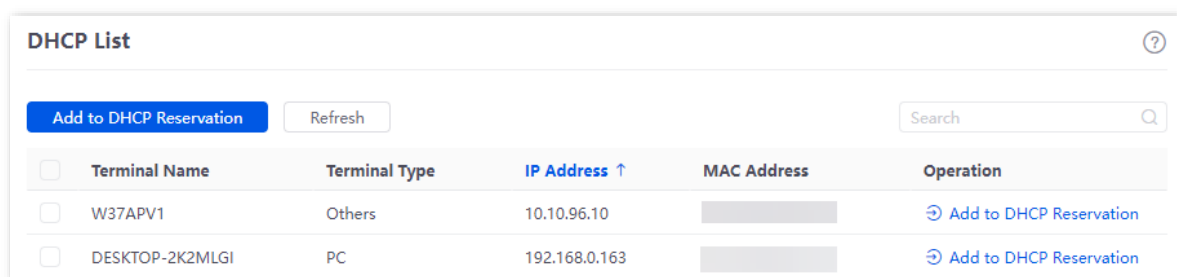

<input type="checkbox"/>	Terminal Name	Terminal Type	IP Address ↑	MAC Address	Operation
<input type="checkbox"/>	W37APV1	Others	10.10.96.10		<a href="#">Add to DHCP Reservation</a>
<input type="checkbox"/>	DESKTOP-2K2MLGI	PC	192.168.0.163		<a href="#">Add to DHCP Reservation</a>

### Parameter description

Parameter	Description
Terminal Name	Specifies the name of the client.
Terminal Type	Specifies the client types such as smartphone, PAD and PC. If the client type is not recognized, <b>Others</b> will be displayed.
IP Address	Specifies the IP address of the client.
MAC Address	Specifies the MAC address of the client.
Operation	Used to add to DHCP reservation. <a href="#">Add to DHCP Reservation</a> : Used to assign the current IP address as a static IP address to the client. After added successfully, the client will appear in the <a href="#">DHCP reservation</a> list.

# 6 AP management

## 6.1 Overview

The router integrates the functions of wireless controller to manage IP-COM fat APs, configure wireless networks for APs and maintain APs in batches. The workload of managing large-scale wireless networks can be greatly reduced.

### To add an AP to the router

To be managed by the router, the AP needs to be found and added to the router. When the router is used as the primary router, the AP can be added to the router as follows.

1. Enable the AP to obtain its IP address.

IP-COM fat APs support the DHCP client function. When the AP is enabled, the AP automatically obtains its own IP address, gateway IP address and IP address of the DNS server.

2. Enable the AP to obtain the IP address of the router.

The router periodically broadcasts its IP address on the network. By monitoring the broadcast, the AP can obtain the IP address of the router.

3. Enable the AP to send a join request to the router.

After obtaining the IP address of the router, the AP sends a join request to the IP address.

4. Enable the router to respond to the join request.

After the router responds to the join request, the AP joins the router successfully.

## 6.2 Configuration wizard

Procedure	Task	Description
1	<a href="#">Configure network</a>	Optional. By default, the router has created a VLAN interface named <b>VLAN_Default</b> . The default IP address of this interface is <b>192.168.0.252</b> , and the <a href="#">User DHCP Default</a> and <a href="#">AP DHCP Default</a> policies are configured.
2	<a href="#">Set AP management mode</a>	Optional. By default, the AP management mode and configuration auto delivery function of the router have been enabled, and the <b>AP_DHCP_Default</b> policy has been added to the <b>VLAN_Default</b> interface.
3	<a href="#">Configure wireless policies</a>	Optional. By default, the router has created an SSID policy named <b>SSID1_Default</b> , and an RF policy named <b>RF_Default</b> .
4	<a href="#">Configure AP group policy</a>	Optional. By default, the router has created an AP group policy named <b>APGroup_Default</b> .
5	<a href="#">Separate APs to AP groups</a>	Optional. By default, the router has separated the managed APs to <b>APGroup_Default</b> . You can modify them based on the actual situation.

## 6.3 AP management mode

[Log in to the web UI of the router](#), and navigate to **AP > AP Management Mode** to enter the page.

On this page, you can set the AP management mode, configure the auto delivery function and add the AP DHCP policy for the VLAN. The router only supports IP-COM fat APs.

M30V3.1 is used as an example. The AP management mode and configuration auto delivery functions are enabled by default.

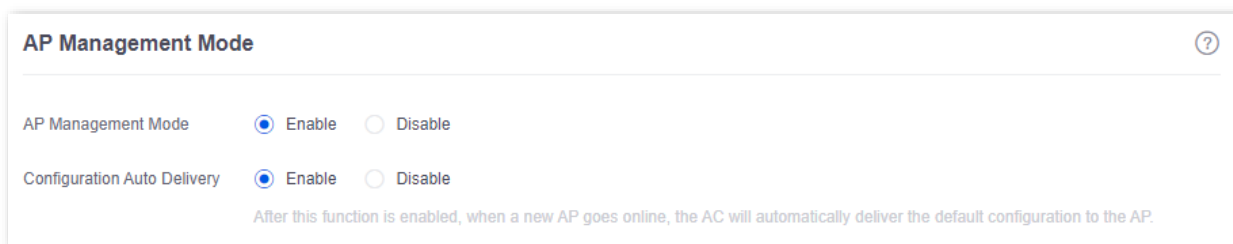



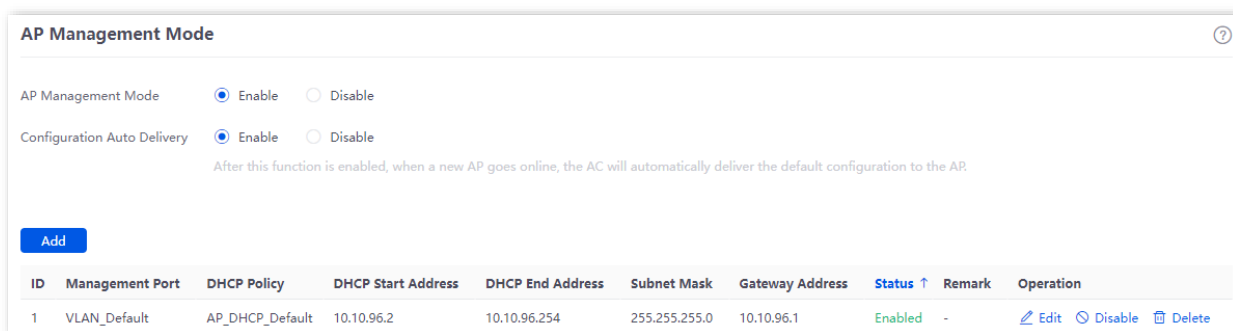

M30V3.0 is used as an example. The AP management mode and configuration auto delivery functions are enabled by default. and **AP\_DHCP\_Default** policy is added to **VLAN\_Default** port. If a new [VLAN](#) is added and the AP DHCP policy is configured for the new VLAN interface on the [DHCP Server](#) page, you need to click **Add** to manually apply the AP DHCP policy for the new VLAN to make the AP DHCP policy take effect and assign an IP address to the AP.



### Parameter description

Parameter	Description
AP Management Mode	Used to enable or disable the AP management function.
Configuration Auto Delivery	After this function is enabled, when a new AP goes online, or an offline AP goes online, the router will automatically add the AP to <b>APGroup_Default</b> , that is, deliver the default configuration to the AP.
ID	Specifies the number of the policy.
Management Port	Specifies the VLAN. Only APs connected to the management port can be managed.

Parameter	Description
DHCP Policy	<p>Specifies the DHCP policy delivered to the managed AP.</p> <p> <b>Tip</b></p> <p>If it is a new VLAN, you need to add an AP DHCP policy in <a href="#">DHCP Server</a>.</p>
DHCP Start Address	Specify the start or end address of the DHCP address pool delivered to the AP.
DHCP End Address	
Subnet Mask	Specifies the subnet mask of the DHCP.
Gateway Address	Specifies the gateway address of the DHCP.
Status	Specifies the current AP DHCP policy status, including <b>Enabled</b> , <b>Disabled</b> and <b>Expired</b> .
Remark	Specifies the introduction to the AP DHCP policy. The remark is optional.
Operation	<p>Used to edit, enable, disable or delete the AP DHCP policy.</p> <p> <b>Edit</b> : Used to modify the AP DHCP policy.</p> <p> <b>Enable</b> : Used to enable the AP DHCP policy.</p> <p> <b>Disable</b> : Used to disable the AP DHCP policy.</p> <p> <b>Delete</b> : Used to delete the AP DHCP policy.</p>



## 6.4 Wireless policy

On this page, you can configure policies for APs to be used in [AP Group Policy](#) in advance. The policies include the SSID policy, RF policy, VLAN policy and advanced policy.

### 6.4.1 SSID policy

[Log in to the web UI of the router](#), and navigate to **AP > Wireless Policy > SSID Policy** to enter the page.

SSID policy is used to configure the SSID-related parameters of the AP.

You can click  to select parameters to be displayed.

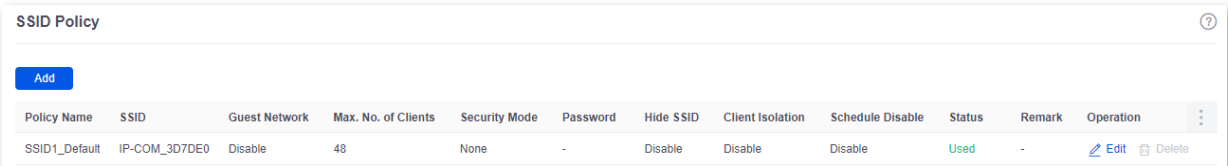

Policy Name	SSID	Guest Network	Max. No. of Clients	Security Mode	Password	Hide SSID	Client Isolation	Schedule Disable	Status	Remark	Operation
SSID1_Default	IP-COM_3D7DE0	Disable	48	None	-	Disable	Disable	Disable	Used	-	<a href="#">Edit</a> <a href="#">Delete</a>

By default, the router has created an SSID policy named **SSID1\_Default**. You can click **Add** to add a new SSID policy.

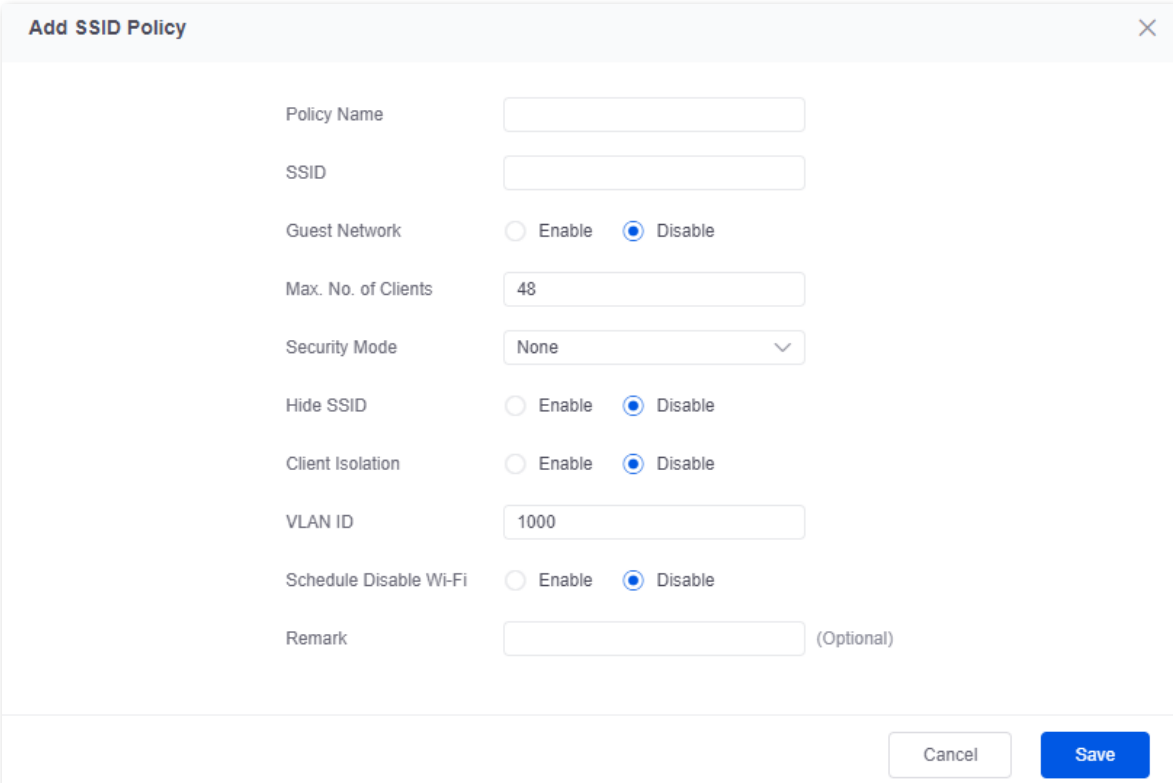

**Add SSID Policy**

Policy Name:

SSID:

Guest Network:  Enable  Disable

Max. No. of Clients:

Security Mode:

Hide SSID:  Enable  Disable



Client Isolation:  Enable  Disable



VLAN ID:

Schedule Disable Wi-Fi:  Enable  Disable

Remark:  (Optional)

## Parameter description

Parameter	Description
Policy Name	Specifies the name of the SSID policy.
SSID	Specifies the name of the wireless network.
Guest Mode	After enabling, the SSID is used as guest network. Users connected to the SSID can only access the internet, but cannot access each other or LAN.
Max No. of Clients	<p>Specifies the maximum number of clients allowed to connect to the wireless network.</p> <p> <b>Tip</b></p> <p>Generally, the maximum number of IP-COM clients is <b>128</b>. If you want to deliver multiple SSID policies to the same AP, you need to plan the maximum number of clients of each policy in advance. Ensure the sum of maximum number of clients of the SSID policies does not exceed 128.</p>
Security Mode	<p>Specifies the security modes of the SSID policy.</p> <ul style="list-style-type: none"> <li>- <b>None:</b> It indicates that the wireless network has no password. For the security of the network, this option is not recommended.</li> <li>- <b>WPA-PSK and WPA2-PSK:</b> They indicate that WPA pre-shared keys are used for network authentication, which is ideal for individual and domestic scenarios.</li> <li>- <b>WPA3-SAE and WPA3-SAE/WPA2-PSK:</b> They indicate that the wireless network is authenticated with a WPA pre-shared key, which is more secure than WPA2. Some smartphones do not support WPA3, so <b>WPA3-SAE/WPA2-PSK</b> is recommended.</li> <li>- <b>WPA and WPA2:</b> They indicate that 802.1x is used for network authentication and generating root keys to encrypt data, which is suitable for scenarios with high-security requirements such as enterprises.</li> </ul>
Encryption	<p>Specifies the encryption when the security mode is WPA-PSK, WPA2-PSK, WPA3-SAE, WPA3-SAE/WPA2-PSK, WPA and WPA2.</p> <ul style="list-style-type: none"> <li>- <b>AES:</b> Specifies the Advanced Encryption Standard.</li> <li>- <b>TKIP:</b> Specifies the Temporal Key Integrity Protocol. Under <b>TKIP</b> mode, the AP can only use a lower rate (maximum 54 Mbps) than under <b>AES</b> mode.</li> <li>- <b>TKIP&amp;AES:</b> Specifies that both the <b>AES</b> and <b>TKIP</b> are compatible.</li> </ul> <p> <b>Tip</b></p> <p><b>WPA3-SAE</b> only supports <b>AES</b>.</p>
Password	Specifies the pre-shared keys when the security modes are WPA-PSK, WPA2-PSK, WPA3-SAE and WPA3-SAE/WPA2-PSK. The users need to enter the wireless password when connecting to the SSID.

Parameter	Description
Key Update Interval	Specifies the key update interval when the security mode is WPA-PSK, WPA2-PSK, WPA3-SAE and WPA3-SAE/WPA2-PSK. A short key update interval can enhance the security of WPA data. 0 means no update.
Radius Server Address	
Authentication Key	Specify the IP address, shared key and authentication port of the RADIUS Server. They are required only when <b>Security Mode</b> is set to <b>WPA</b> or <b>WPA2</b> .
Authentication Port	
Hide SSID	Used to enable or disable the hide SSID function. After this function is enabled, the SSID will be hidden and the wireless network will not appear in the available network list of wireless clients (such as smartphones), enhancing the security of the wireless network.  If you want to connect to the hidden wireless network, manually enter the SSID on your wireless clients.
Client Isolation	Used to enable or disable the client isolation function. With the <b>Client Isolation</b> enabled, clients cannot access each other.
VLAN ID	Specifies the VLAN to which the SSID belongs. The value range is 1, 10 – 4094.
Schedule Disable Wi-Fi	With this function enabled, you can set the periods (up to 4) for the wireless network to be disabled. Within the period, the router will automatically disable the wireless network of the AP managed by the router.
Status	Specifies the status of the SSID policy.
Remark	Specifies the introduction to the SSID policy. The remark is optional.
Operation	Used to edit or delete an SSID policy.   <b>Edit</b> : Used to modify the policy.  <b>Delete</b> : Used to delete the policy.   <b>Tip</b>  Generally, keep at least one SSID policy, so the last policy cannot be deleted. The policy in use cannot be deleted. Remove the policy reference before deleting a policy in use.

## 6.4.2 RF policy

[Log in to the web UI of the router](#), and navigate to **AP > Wireless Policy > RF Policy** to enter the page.

RF policy is used to configure the basic RF parameters of the AP.

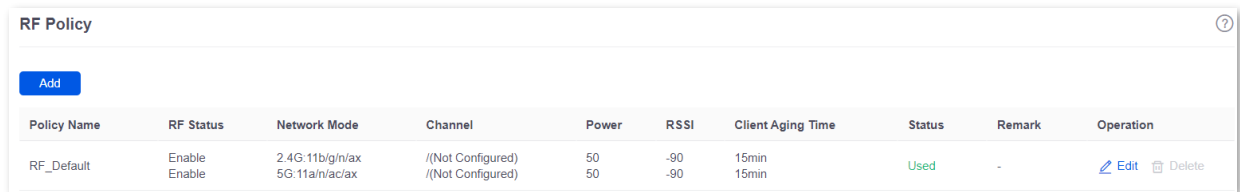

Policy Name	RF Status	Network Mode	Channel	Power	RSSI	Client Aging Time	Status	Remark	Operation
RF_Default	Enable Enable	2.4G: 11b/g/n/ax 5G: 11a/n/ac/ax	/((Not Configured)) /((Not Configured))	50 50	-90 -90	15min 15min	Used	-	<a href="#">Edit</a> <a href="#">Delete</a>

By default, the router has created an RF policy named **RF\_Default**. You can click **Add** to add a new RF policy.

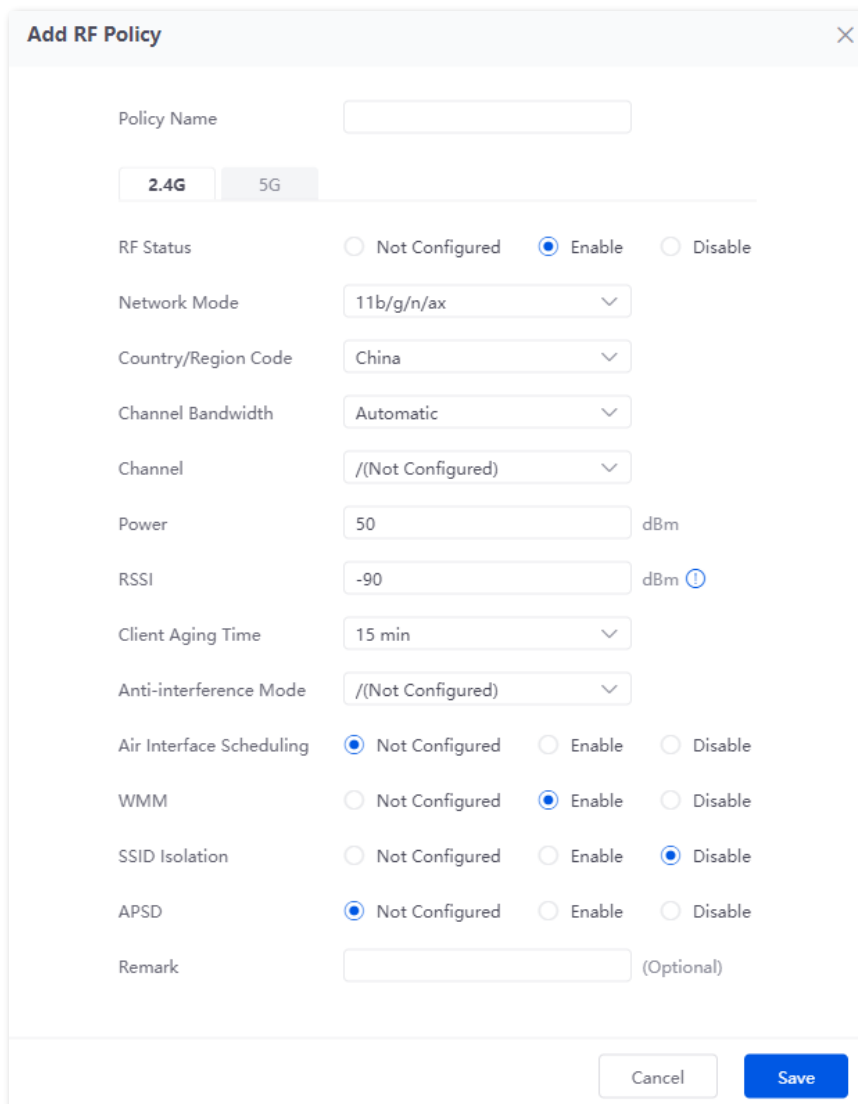

**Add RF Policy**

Policy Name:

**2.4G** | 5G

RF Status:  Not Configured  Enable  Disable

Network Mode:

Country/Region Code:

Channel Bandwidth:

Channel:

Power:  dBm

RSSI:  dBm ⓘ

Client Aging Time:

Anti-interference Mode:

Air Interface Scheduling:  Not Configured  Enable  Disable

WMM:  Not Configured  Enable  Disable

SSID Isolation:  Not Configured  Enable  Disable

APSD:  Not Configured  Enable  Disable



Remark:  (Optional)

## Parameter description

Parameter	Description
Policy Name	Specifies the name of the RF policy.
2.4G 5G	Specify the parameters for RF policies under 2.4 GHz and 5 GHz wireless networks.
RF Status	<p>Specifies the status of the WiFi function. <b>Not Configured</b> indicates that the RF status of the corresponding frequency band of the AP is not modified.</p> <ul style="list-style-type: none"> <li>- <b>Enable:</b> Select it to enable the WiFi function of the frequency band.</li> <li>- <b>Disable:</b> Select it to disable the WiFi function of the frequency band.</li> </ul>
Network Mode	<p>Specifies the wireless network mode of the corresponding band.</p> <p>Network modes of the 2.4 GHz frequency band include <b>11b</b>, <b>11g</b>, <b>11b/g</b>, <b>11b/g/n</b> and <b>11b/g/n/ax</b>.</p> <ul style="list-style-type: none"> <li>- <b>11b:</b> The AP works in 802.11b wireless network mode.</li> <li>- <b>11g:</b> The AP works in 802.11g wireless network mode.</li> <li>- <b>11b/g:</b> The AP works in 802.11b/g wireless network mode.</li> <li>- <b>11b/g/n:</b> The AP works in 802.11b/g/n wireless network mode.</li> <li>- <b>11b/g/n/ax:</b> The AP works in 802.11b/g/n/ax wireless network mode.</li> </ul> <p>Network modes of the 5 GHz frequency band include <b>11a</b>, <b>11a/n</b>, <b>11ac</b>, and <b>11a/n/ac/ax</b>.</p> <ul style="list-style-type: none"> <li>- <b>11a:</b> The AP works in 802.11a wireless network mode.</li> <li>- <b>11a/n:</b> The AP works in 802.11a/n wireless network mode.</li> <li>- <b>11ac:</b> The AP works in 802.11ac wireless network mode.</li> <li>- <b>11a/n/ac/ax:</b> The AP works in 802.11a/n/ac/ax wireless network mode.</li> </ul>
Country/Region Code	Specifies the country or region where the AP is located. Please select the correct country or region.

Parameter	Description
Channel Bandwidth	<p>Specifies the bandwidth of the working channel. A high channel bandwidth means a higher transmission rate, but the penetration capability is reduced and the transmission distance is shortened.</p> <ul style="list-style-type: none"> <li>- <b>Automatic:</b> The AP automatically adjusts the channel bandwidth based on the surrounding environment.</li> <li>- <b>20M:</b> The AP uses the 20 MHz channel bandwidth.</li> <li>- <b>40M:</b> The AP uses the 40 MHz channel bandwidth.</li> <li>- <b>80M:</b> This channel bandwidth is available for the 5 GHz only. The AP uses the 80 MHz channel bandwidth.</li> <li>- <b>160M:</b> This channel bandwidth is available for the 5 GHz only. The AP uses the 160 MHz channel bandwidth.</li> </ul> <p> <b>Tip</b></p> <p><b>20M</b> is available for each network mode. <b>40M</b> is available for <b>11b/g/n, 11b/g/n/ax, 11a/n, 11ac</b> and <b>11a/n/ac/ax</b>. <b>80M</b> is available for <b>11ac</b> and <b>11a/n/ac/ax</b>. <b>160M</b> is only available for <b>11a/n/ac/ax</b>.</p>
Channel	<p>Specifies the channel in which the wireless data is transmitted and received. The available channels are determined by the current country/region and wireless band.</p> <ul style="list-style-type: none"> <li>- <b>/(Not Configured):</b> Retain the current configurations of the AP.</li> <li>- <b>Automatic:</b> The AP automatically detects the occupation rate of channels and selects the appropriate working channel accordingly.</li> </ul> <p>If the connection drops, freezes or slow internet occurs frequently when you are using the wireless network, you can try changing the working channel. You can check the channels with a low occupation rate and little interference using software tools (such as WiFi analyzer).</p>
Power	<p>Specifies the transmit power of the corresponding band.</p> <p>The higher the transmit power, the wider the WiFi coverage. However, an appropriate reduction of transmit power can improve the performance and security of the wireless network.</p>
RSSI	<p>Specifies the minimum wireless signal strength can be received by the band. Clients with a lower signal strength value cannot connect to the AP.</p> <p>When there are multiple APs in the surroundings, an appropriate <b>RSSI</b> value helps ensure wireless clients connect to the APs with a stronger signal.</p>
Client Aging Time	<p>If a client generates no data communication within this time after connecting to the wireless network, the AP will cut this client off.</p>

Parameter	Description
Anti-interference Mode	<p>Interference mitigation mode of this device. Only supported in 2.4 GHz.</p> <ul style="list-style-type: none"> <li>– <b>0</b>: Interference suppression measures are disabled.</li> <li>– <b>1</b>: Suppress same frequency interference for weak radio environment, such as the same frequency interference caused by microwave ovens, smartphones and bluetooth devices.</li> <li>– <b>2</b>: Forcibly suppress moderate interference for bad radio environment when the number of wireless signal interference sources is less than 30.</li> <li>– <b>3</b>: Automatically suppress critical interference for heavy loading radio environment.</li> <li>– <b>4</b>: Automatically suppress critical interference and reduce noise when the number of wireless signal interference sources is more than 30, such as high-density scenarios.</li> <li>– <b>/(Not Configured)</b>: The router does not deliver the anti- interference mode configuration to the AP. The AP uses the anti-interference mode configured on its web UI.</li> </ul>
Airtime Fairness	<p>If this function is enabled, the same download time is assigned to users experiencing different download rates, ensuring a better experience for high-rate users.</p>
WMM	<p>Specifies the WiFi Multi-media, which provides basic solutions for wireless QoS. When this function is enabled, audio and video data are forwarded in priority. To improve the performance of AP in wireless multimedia data transmission (for example, online videos), this function is enabled by default.</p>
SSID Isolation	<p>Used to enable or disable the SSID isolation function. When it is enabled, devices under different SSIDs cannot communicate with each other.</p>
APSD	<p>Specifies the Automatic Power Save Delivery, which is the <b>WMM</b> power-saving certification protocol of the WiFi Alliance. Enabling <b>APSD</b> can reduce the power consumption of the AP.</p>
5G Preferred	<p>If the client supports 2.4 GHz and 5 GHz, with this function enabled, 5 GHz is used in priority when the 5 GHz signal strength is not less than the RSSI value.</p> <p> Tip</p> <ul style="list-style-type: none"> <li>– This function is only available for the 5 GHz band. To use this function, the 2.4 GHz and 5 GHz bands of the AP must be enabled and the SSID, encryption mode and passwords for the 2.4 GHz and 5 GHz bands must be consistent.</li> <li>– 5GHz Priority Threshold is configured on the web UI of the AP.</li> </ul>
Status	<p>Specifies the status of the RF policy.</p>
Remark	<p>Specifies the introduction to the RF policy. The remark is optional.</p>

Parameter	Description
Operation	<p>Used to edit or delete an RF policy.</p> <p> <b>Edit</b>: Used to modify the policy.</p> <p> <b>Delete</b>: Used to delete the policy.</p> <p> <b>Tip</b></p> <p>Generally, keep at least one RF policy, so the last policy cannot be deleted. The policy in use cannot be deleted. Remove the policy reference before deleting a policy in use.</p>

### 6.4.3 VLAN policy

[Log in to the web UI of the router](#), and navigate to **AP > Wireless Policy > VLAN Policy** to enter the page.

VLAN policy is used to configure the basic VLAN parameters of the AP.



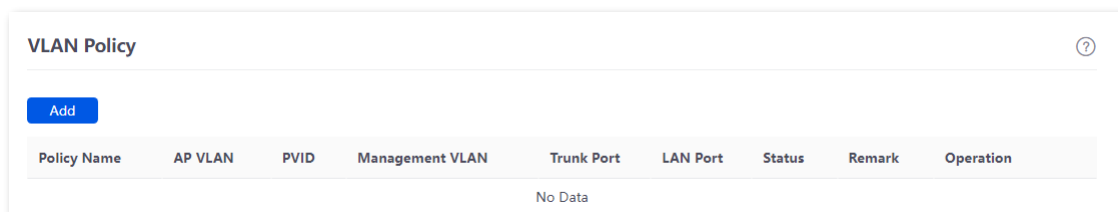

You can configure the VLAN policy to associate the VLAN-related settings of the AP (such as the enabling status of the AP VLAN, management VLAN and Trunk port).



You can click **Add** to add a new VLAN policy.



## Parameter description

Parameter	Description
Policy Name	Specifies the name of the VLAN policy.
AP VLAN	Used to enable or disable the AP VLAN function.
PVID	Specifies the ID of the default native VLAN of the trunk port of the AP.
Management VLAN	<p>Specifies the ID of the management VLAN. The default value is 1.</p> <p>After changing the management VLAN, you can manage the AP only after connecting the router to the new management VLAN and you can log in to the web UI of the AP again only after connecting your client (such as the management computer) to the new management VLAN.</p>
Trunk Port	<p>Used to select the trunk ports that allow data of all VLANs to pass.</p> <p> <b>Note</b></p> <p>After the 802.1Q VLAN function is enabled, at least one LAN port needs to be selected as the Trunk port. If this policy is applied for only one LAN port, set LAN0 as the Trunk port. Otherwise, the configuration may fail.</p>
LAN Port	<p>Specifies the VLAN ID of the wired LAN port (non-Trunk port) of the AP. This parameter is required only when the AP that uses the current policy has two LAN ports. The wired LAN port that cannot be modified is the Trunk port.</p> <p> <b>Tip</b></p> <p>After the 802.1Q VLAN function is enabled, the wired LAN port (non-Trunk port) and wireless port of the SSID are Access ports. Their PVIDs are the same as their own VLAN IDs.</p>
Status	Specifies the status of the VLAN policy.
Remark	Specifies the introduction to the VLAN policy. The remark is optional.
Operation	<p>Used to edit or delete a VLAN policy.</p> <p> <b>Edit</b>: Used to modify the policy.</p> <p> <b>Delete</b>: Used to delete the policy.</p> <p> <b>Tip</b></p> <p>Generally, keep at least one VLAN policy, so the last policy cannot be deleted. The policy in use cannot be deleted. Remove the policy reference before deleting a policy in use.</p>



## 6.4.4 Advanced policy

[Log in to the web UI of the router](#), and navigate to **AP > Wireless Policy > Advanced Policy** to enter the page.

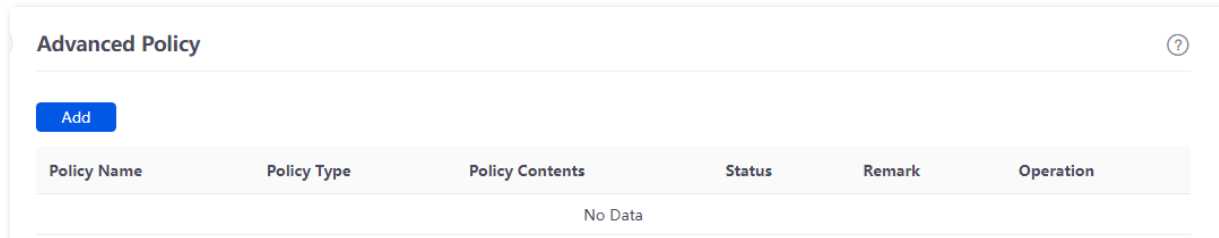
On this page, you can configure advanced policies (including maintenance policies, alarm policies and password policies).



### Parameter description

Parameter	Description
Policy Name	Specifies the name of the advanced policy.
Policy Type	Specifies the type of advanced policy, including <b>Maintenance Policy</b> , <b>Alarm Policy</b> and <b>Password Policy</b> .
Policy Contents	Specifies the contents of the policy.
Status	Specifies the status of the advanced policy.
Remark	Specifies the introduction to the advanced policy. The remark is optional.
Operation	Used to edit or delete an advanced policy.  <b>Edit</b> : Used to modify the policy.  <b>Delete</b> : Used to delete the policy.  <b>Tip</b> The policy in use cannot be deleted. Remove the policy reference before deleting a policy in use.

### Maintenance policy

This policy is used to configure the customized reboot parameters of the AP. Rebooting the AP can make it work with high performance. It is recommended that the AP be automatically rebooted during idle periods.

[Log in to the web UI of the router](#), and navigate to **AP > Wireless Policy > Advanced Policy** to enter the page. You can click **Add** to add a new maintenance policy.

The screenshot shows a dialog box titled "Add Advanced Policy" with a close button (X) in the top right corner. The dialog contains the following fields:

- Policy Name: A text input field.
- Policy Type: A dropdown menu with "Maintenance Policy" selected.
- Reboot Settings: A dropdown menu with "Cyclic Reboot" selected.
- Reboot Time Interval: A dropdown menu with "1 day(s)" selected.
- Remark: A text input field with "(Optional)" to its right.

At the bottom right of the dialog, there are two buttons: "Cancel" and "Save".

### Parameter description

Parameter	Description
Policy Name	Specifies the name of the maintenance policy.
Policy Type	Specifies the type of advanced policy, including <b>Maintenance Policy</b> , <b>Alarm Policy</b> and <b>Password Policy</b> .
Reboot Settings	Specifies the type of maintenance policy. <ul style="list-style-type: none"> <li>– <b>Scheduled Reboot</b>: The AP reboots once at the specified time point on the specified dates.</li> <li>– <b>Cyclic Reboot</b>: The AP reboots once at the interval specified by <b>Reboot Time Interval</b>.</li> </ul>
Time Repeat	Specify the reboot time of the AP when <b>Reboot Settings</b> is set to <b>Scheduled Reboot</b> .
Reboot Time Interval	Specifies the interval at which the AP reboots when <b>Reboot Settings</b> is set to <b>Cyclic Reboot</b> .
Status	Specifies the status of the policy.
Remark	Specifies the introduction to the policy. The remark is optional.

## Alarm policy

On this page, you can configure alarm policies for the AP, so that the router will generate alarms after alarm events occur on the AP. The administrator can view such alarms to monitor the network status in real time.

[Log in to the web UI of the router](#), and navigate to **AP > Wireless Policy > Advanced Policy** to enter the page. You can click **Add** to add a new alarm policy.

The screenshot shows a dialog box titled "Add Advanced Policy" with a close button (X) in the top right corner. The dialog contains the following fields and options:

- Policy Name:** A text input field.
- Policy Type:** A dropdown menu currently showing "Alarm Policy".
- Log Notification:** Radio buttons for "Enable" (selected) and "Disable".
- AP Fault Alarm:** Radio buttons for "Enable" (selected) and "Disable".
- AP Traffic Alarm:** Radio buttons for "Enable" and "Disable" (selected).
- AP Connections Alarm:** Radio buttons for "Enable" (selected) and "Disable".
- Connections Alarm Threshold:** A dropdown menu currently showing "50".
- Remark:** A text input field with the label "(Optional)".

At the bottom right of the dialog are two buttons: "Cancel" and "Save".

### Parameter description

Parameter	Description
Policy Name	Specifies the name of the alarm policy.
Policy Type	Specifies the type of advanced policy, including <b>Maintenance Policy</b> , <b>Alarm Policy</b> and <b>Password Policy</b> .
Log Notification	Used to enable or disable the log notification function. After it is enabled, the AP alarms will be displayed in <b>AP Alarm Log</b> and <b>AP Running Log</b> in <a href="#">Running Log</a> .
AP Fault Alarm	Used to enable or disable the AP fault alarm function. When it is enabled, if the AP is faulty (such as reboot, offline, online), the AP will send an alarm through the <a href="#">Log Notification</a> .
AP Traffic Alarm	Used to enable or disable the AP traffic alarm function. With this function enabled, when the total traffic exceeds the specified threshold, an alarm notification will be triggered. The notification can be sent by <a href="#">Log Notification</a> .

Parameter	Description
Traffic Alarm Threshold	Specifies the threshold of the AP traffic alarm. When the total AP traffic exceeds the threshold, an alarm notification will be triggered.
AP Connections Alarm	Used to enable or disable the AP connections alarm function. With this function enabled, when the number of AP connections exceeds the specified threshold, an alarm notification will be triggered. The notification can be sent by <a href="#">Log Notification</a> .
Connections Alarm Threshold	Specifies the threshold of connections alarm. When the number of AP connections exceeds the threshold, an alarm notification will be triggered.
Status	Specifies the status of the policy.
Remark	Specifies the introduction to the policy. The remark is optional.

## Password policy

On this page, you can configure password policies for the AP to preset the account and password used to log in to the web UI of the AP.

The default login account and password are **admin**. To prevent unauthorized users from entering the web UI of the AP and modifying settings, change the login account and password immediately upon your first login.

[Log in to the web UI of the router](#), and navigate to **AP > Wireless Policy > Advanced Policy** to enter the page. You can click **Add** to add a new password policy.

**Add Advanced Policy** [X]

Policy Name

Policy Type

Device Login Account

Device Login Password

Confirm Login Password

Remark  (Optional)

Cancel Save

### Parameter description

Parameter	Description
Policy Name	Specifies the name of the password policy.
Policy Type	Specifies the type of advanced policy, including <b>Maintenance Policy</b> , <b>Alarm Policy</b> and <b>Password Policy</b> .
Device Login Account	Specifies the login account of the AP.
Device Login Password	Specifies the login password of the AP.
Confirm Login Password	Used to confirm the login password of the AP.
Status	Specifies the status of the policy.
Remark	Specifies the introduction to the policy. The remark is optional.

## 6.5 AP group policy

[Log in to the web UI of the router](#), and navigate to **AP > Wireless Policy > AP Group Policy** to enter the page.

AP group policy is used to combine wireless policies and deliver them to corresponding APs.

You can click  to select parameters to be displayed.

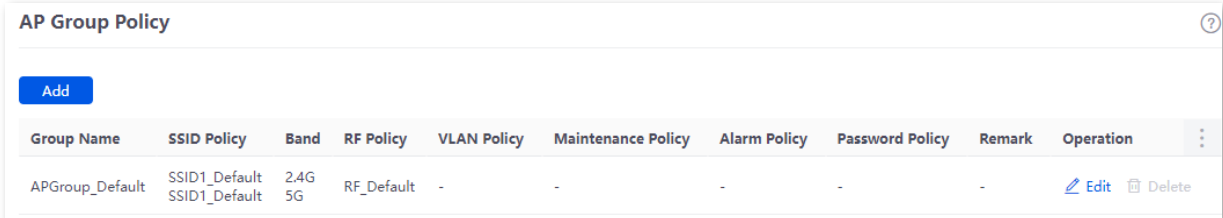



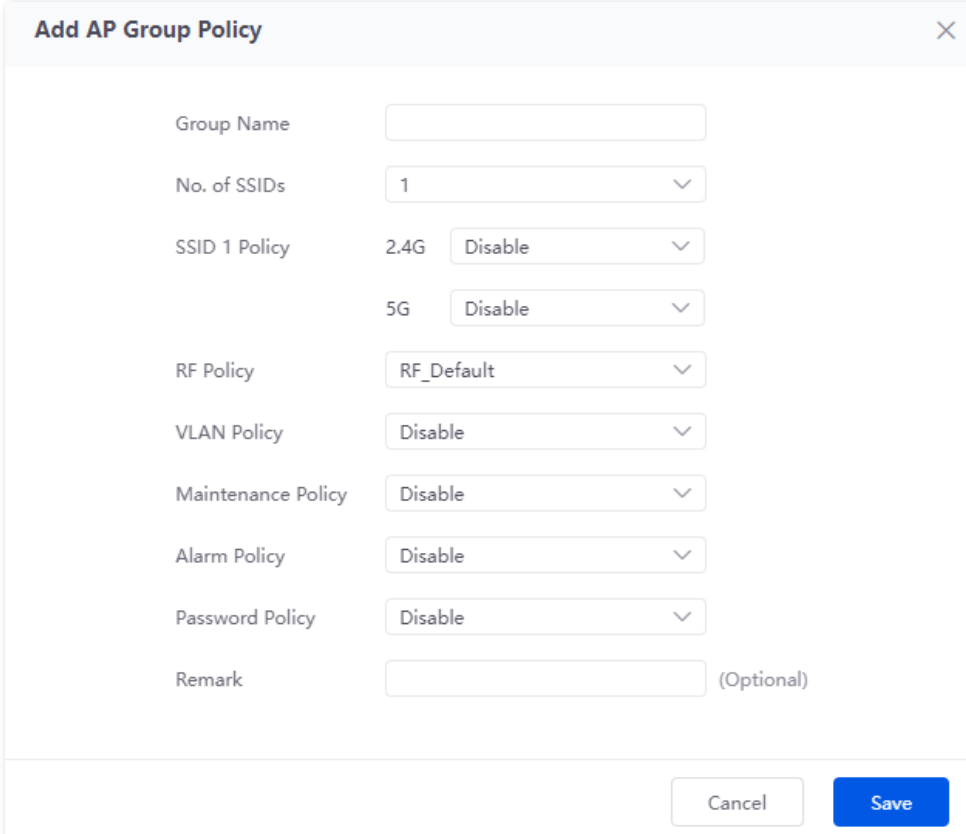

Group Name	SSID Policy	Band	RF Policy	VLAN Policy	Maintenance Policy	Alarm Policy	Password Policy	Remark	Operation
APGroup_Default	SSID1_Default SSID1_Default	2.4G 5G	RF_Default	-	-	-	-	-	<a href="#">Edit</a> <a href="#">Delete</a>

By default, the router has created an AP group policy named **APGroup\_Default**. You can click **Add** to add a new AP group policy.



### Parameter description

Parameter	Description
Group Name	Specifies the name of the AP group policy.

Parameter	Description
No. of SSIDs	Specifies the number of the SSIDs.
SSID Policy	<p>Specifies the SSID policy to be used in the AP group policy. The SSID policy should be configured in <a href="#">SSID Policy</a> in advance.</p> <p>If multiple SSIDs are configured, each SSID should be used with a different SSID policy.</p>
2.4G	<p>Specify the working frequency band of the AP.</p> <ul style="list-style-type: none"> <li>- <b>2.4 GHz:</b> The frequency band of the AP is <b>2.4 GHz</b>.</li> <li>- <b>5 GHz:</b> The frequency band of the AP is <b>5 GHz</b>.</li> </ul>
5G	<p> Tip</p> <p>If your AP only supports 2.4 GHz, select 2.4 GHz or 2.4 GHz&amp;5 GHz. If you select 5 GHz, the configuration is invalid.</p>
RF Policy	Specifies the RF policy to be used in the AP group policy. The RF policy should be configured in <a href="#">RF Policy</a> in advance.
VLAN Policy	Specifies the VLAN policy to be used in the AP group policy. The VLAN policy should be configured in <a href="#">VLAN Policy</a> in advance.
Maintenance Policy	Specifies the maintenance policy to be used in the AP group policy. The maintenance policy should be configured in <a href="#">Advanced Policy</a> in advance.
Alarm Policy	Specifies the alarm policy to be used in the AP group policy. The alarm policy should be configured in <a href="#">Advanced Policy</a> in advance.
Password Policy	Specifies the password policy to be used in the AP group policy. The password policy should be configured in <a href="#">Advanced Policy</a> in advance.
Remark	Specifies the introduction to the AP group policy. The remark is optional.
Operation	<p>Used to edit or delete an AP group policy.</p> <p> <b>Edit</b>: Used to modify the policy.</p> <p> <b>Delete</b>: Used to delete the policy.</p> <p> Tip</p> <p>Generally, keep at least one AP group policy, so the last policy cannot be deleted. The policy in use cannot be deleted. Remove the policy reference before deleting a policy in use.</p>



## 6.6 AP list and maintenance

### 6.6.1 Overview



[Log in to the web UI of the router](#), and navigate to **AP > AP List and Maintenance** to enter the page.



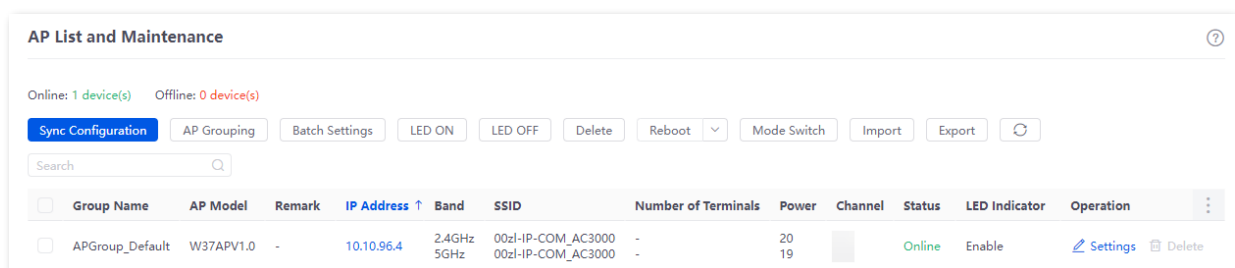

On this page, you can scan the AP list, deliver the AP group policies to corresponding APs and configure the maintenance operations such as upgrading and restarting APs. Managed APs will be added to **APGroup\_Default** by default.

You can click  to select parameters to be displayed.





#### Button description



Button	Description
Sync Configuration	Used to synchronize the configuration of the selected APs.
AP Grouping	Specifies the AP group policy to be used on the selected APs. The AP group policy should be configured in <a href="#">AP Group Policy</a> in advance.
Batch Settings	Used to deliver the configuration to the selected APs in batches.
LED ON	Used to turn on or off the LED indicator of the selected AP.
LED OFF	
Delete	Used to delete the information of offline APs that are selected.
Reboot	Used to reboot the selected APs.
Upgrade	Used to upgrade the firmware of the selected APs.
	 <b>Tip</b> Click  beside <b>Reboot</b> and you can see this function.

Button	Description
Reset	<p>Used to reset the selected APs to factory settings.</p> <p> Tip</p> <p>Click  beside <b>Reboot</b> and you can see this function.</p>
Mode Switch	<p>Used to enable or disable the cloud maintenance function of the AP or switch the management mode of cloud maintenance. For details, refer to <a href="#">set the AP cloud maintenance function</a>.</p> <p> Tip</p> <p>The cloud maintenance function may be unavailable for some APs.</p>
Import	<p>Used to import the configuration information of the selected APs.</p> <p>After importing, only remarks of devices with the same MAC address are replaced. Other information will not synchronize.</p>
Export	Used to export the configuration information of the selected APs.
	Used to refresh the current list.

### Parameter description

Parameter	Description
Online	Specifies the number of online devices.
Offline	Specifies the number of offline devices.
Group Name	Specifies the AP group name.
AP Model	Specifies the AP model.
Remark	Specifies the introduction to the AP.
IP Address	Specifies the IP address that the AP obtains from the AP DHCP server. It is also the login address of the AP.
MAC Address	Specifies the wireless MAC address of the AP.
Firmware	Specifies the current firmware version of the AP.
Band	Specifies the working frequency band of the AP, including <b>2.4 GHz</b> and <b>5 GHz</b> .
SSID	Specifies the current SSID of the AP.

Parameter	Description
Number of Terminals	Specifies the number of the clients that the AP connects to.
Power	Specifies the wireless transmission power of the AP. <b>Policy Delivery</b> indicates that the transmission power of the AP is consistent with the setting in the AP group selected. You can click <b>Settings</b> under <b>Operation</b> to modify it.
Channel	Specifies the wireless channel of the SSID that the client connects to. <b>Policy Delivery</b> indicates that the channel is consistent with the setting in the AP group selected. You can click <b>Settings</b> under <b>Operation</b> to modify it.
5G Preferred	If the client supports 2.4 GHz and 5 GHz, with this function enabled, 5 GHz is used in priority when the 5 GHz signal strength is not less than the RSSI value.  Tip This function is only available for the 5 GHz band.
Management Mode	Specifies the management mode of the AP. For details about the cloud maintenance function, see <a href="#">Set the AP cloud maintenance function</a> .  Tip The cloud maintenance function may be unavailable for some APs.
<a href="#">Management VLAN</a>	Specifies the management VLAN ID of the AP to differentiate it from data VLAN. If this parameter is not set, - is displayed by default.
Wired Port VLAN	Specifies the default VLAN ID of the wired port of the AP.
RF	Specifies the current RF status of the AP.
Online Duration	Specifies the online duration of the online AP.
Offline Duration	Specifies the offline duration of the offline AP.
Status	Specifies the current status of the AP.
LED Indicator	Specifies the current status of the LED indicator of the AP.

Parameter	Description
	Used to edit or delete the AP group policy.
	 <b>Settings</b> : Used to modify the AP group policy.
	 <b>Delete</b> : Used to delete the AP group policy.
Operation	 <b>Tip</b>
	Generally, keep at least one AP group policy, so the last policy cannot be deleted. The policy in use cannot be deleted. Remove the policy reference before deleting a policy in use.

## 6.6.2 Deliver policies to APs



With the configuration auto delivery function enabled, when an AP goes online, it will be added to the **APGroup\_Default** group by default.

1. [Log in to the web UI of the router.](#)
2. (Skip if performed) Configure a wireless policy to be delivered to APs. For details, see [Wireless policy](#) in **AP management**.
3. (Skip if performed) Configure an AP group and add the wireless policy configured in step 2 to an AP group. For details, see [AP group policy](#) in **AP management**.
4. Deliver policies to APs.
  - 1) Navigate to **AP > AP List and Maintenance**.
  - 2) Select the APs to which the policies are to be delivered, and click **AP Grouping**. The following figure is for reference only.

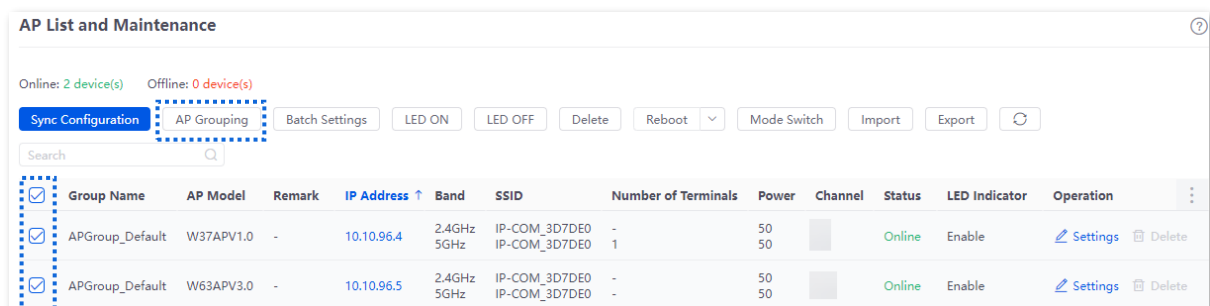

- 3) Select an AP group from the **Select AP Group Policy** drop-down list box, and click **Save**. The following figure is for reference only.

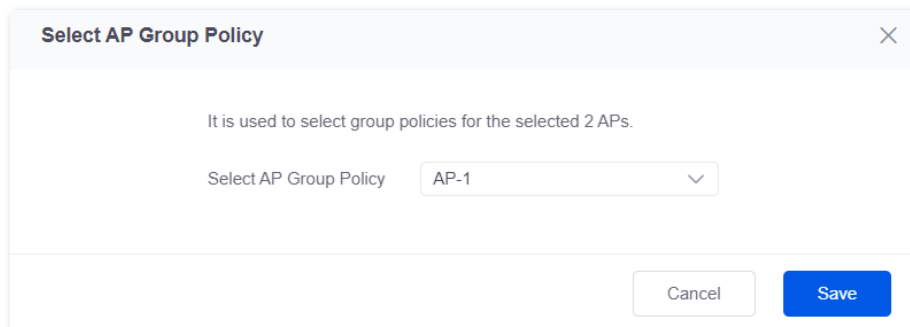

---End

After the APs are added to an AP group, the policies associated with the AP group will be applied to the APs.

### 6.6.3 Batch settings

You can use **Batch Settings** to perform detailed settings for multiple selected APs in a unified manner.



This operation can only be performed on non-offline devices.

1. [Log in to the web UI of the router.](#)
2. Navigate to **AP > AP List and Maintenance**.
3. Select the APs for which detailed settings are to be performed, and click **Batch Settings**. The following figure is for reference only.

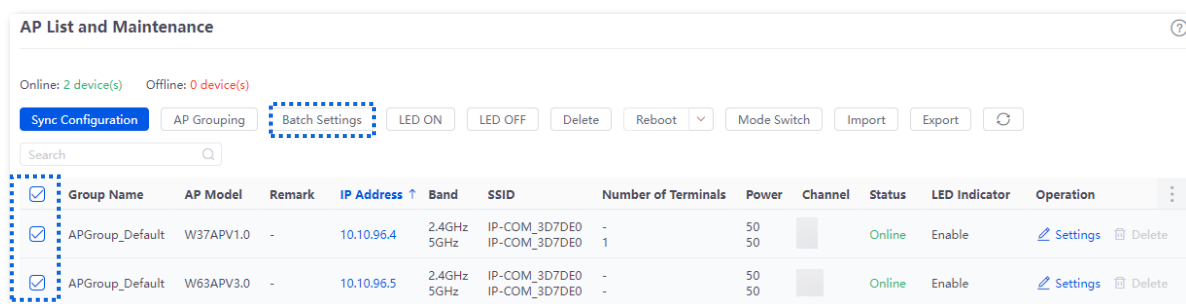

4. Set parameters as required, and click **Save**. The following figure is for reference only.



**/(Not configured)** indicates that the configuration of the AP group to which the AP applies is not modified.

**AP Batch Settings**

Number of Selected APs: 2 device(s)

Remark:  (Optional)

AP Grouping:

**2.4G** | 5G

RF Status:  Not Configured  Enable  Disable

Network Mode:

Country/Region Code:

Channel Bandwidth:

Channel:

Anti-interference Mode:

Power:  dbm ⓘ

RSSI:  dbm ⓘ

Client Aging Time:

Airtime Fairness:  Not Configured  Enable  Disable

WMM:  Not Configured  Enable  Disable

SSID Isolation:  Not Configured  Enable  Disable

APSD:  Not Configured  Enable  Disable

---End

Related configurations for the selected APs will be delivered again.

### Parameter description

Parameter	Description
Number of Selected APs	Specifies the number of APs that are selected currently. It cannot be modified.
Remark	Specifies the introduction of the APs. The remark is optional.
AP Grouping	Specifies the AP group policy to be applied for the selected APs. The AP group policy must be configured in <a href="#">AP group policy</a> in advance.
2.4G	Used to configure parameters for 2.4 GHz and 5 GHz wireless networks. Refer to <a href="#">Parameter description in RF policy</a> .
5G	

## 6.6.4 Set AP cloud maintenance

You can use **Mode Switch** to enable the cloud maintenance function or switch the cloud management mode for selected APs.

To add APs and the router to the same project, keep their **Unique Cloud Code** consistent when enabling the cloud maintenance function.



This operation can only be performed on non-offline devices.

---

### To enable the cloud maintenance function for APs:

1. Obtain the unique cloud code.



- If the cloud maintenance function has been enabled for the router and you need to add the AP and router to the same project, you can obtain the unique cloud code in [Cloud Maintenance](#).
  - Before enabling the cloud maintenance function of the AP, ensure that the AP is connected to the internet.
- 

- 1) Access <https://imsen.ip-com.com.cn> to enter the Profi Cloud Platform.
- 2) Click **Add** in the upper right corner and select **Unique Cloud Code**, and copy the unique cloud code.

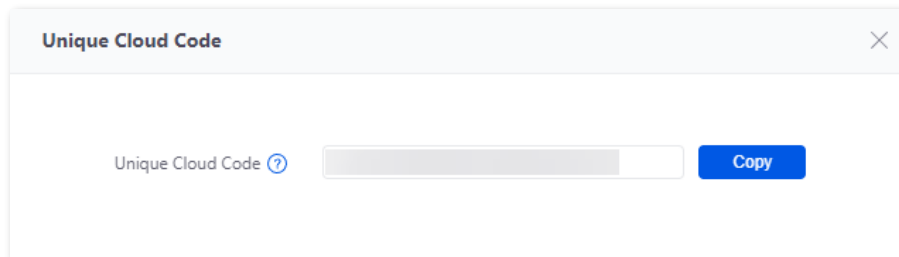

2. Enable the cloud maintenance function for the APs.
  - 1) [Log in to the web UI of the router](#), and navigate to **AP > AP List and Maintenance**.
  - 2) Select the APs for which the cloud maintenance function is to be enabled, and click **Mode Switch**. The following figure is for reference only.

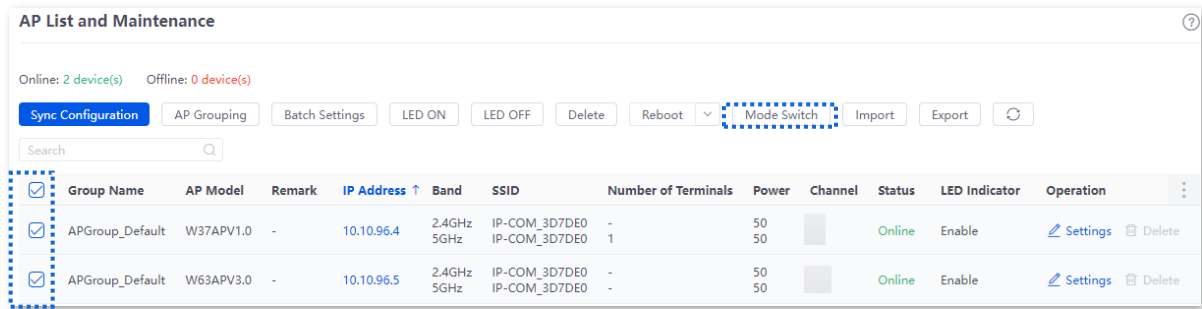

- 3) Set **Cloud Maintenance** to **Enable**, and set **Management Mode** as required (**Cloud Hosting** for example here).
- 4) Enter the unique cloud code obtained in **Unique Cloud Code** and set **Device Info Report** to **Enable**.
- 5) Click **OK**.

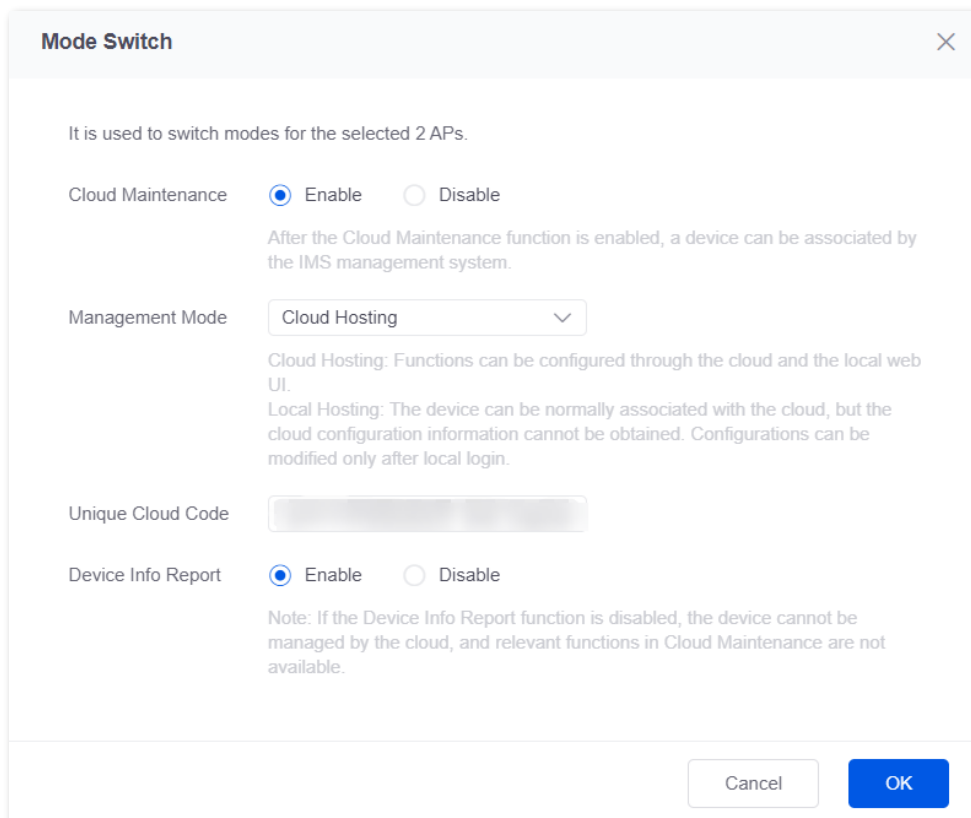

---End

After the cloud maintenance function is enabled for the APs, you can manage them on the ProFi Cloud Platform (<https://imsen.ip-com.com.cn>) or ProFi App.

### Parameter description

Parameter	Description
Cloud Maintenance	Used to enable or disable the cloud maintenance function.



Parameter	Description
Management Mode	<p>Specifies the cloud maintenance management mode.</p> <ul style="list-style-type: none"><li>– <b>Cloud Hosting:</b> Suitable for projects that are managed in a unified manner and the ProFi Cloud Platform or ProFi App is used for maintenance. APs can be managed in the ProFi Cloud Platform and configurations can be delivered to APs through the ProFi Cloud Platform. You can also configure APs by logging in to their web UI locally.</li><li>– <b>Local Hosting:</b> Suitable for projects that are managed and viewed in a unified manner. APs can be managed in the ProFi Cloud Platform or ProFi App and all configurations must be performed on the web UI of the router or the APs.</li></ul>
Unique Cloud Code	<p>Used to associate the device to the ProFi Cloud Management System. You can obtain it on the ProFi Cloud Platform (<a href="https://imsen.ip-com.com.cn">https://imsen.ip-com.com.cn</a>) or the ProFi App.</p>
Device Info Report	<p>Used to enable or disable the device info report function.</p> <p>After this function is enabled, APs can be managed on the ProFi Cloud Platform and AP configurations will be uploaded to the ProFi Cloud Platform.</p>

## 6.7 Wireless user information

[Log in to the web UI of the router](#), and navigate to **AP > Wireless User Information** to enter the page.

On this page, you can view basic information about the users connected to the APs and configure the operations such as forcing the users offline.

You can click  to select parameters to be displayed.



Terminal Name	Terminal Remark	Terminal Type	IP Address ↑	MAC Address	Associated SSID	Band	Signal Strength	Online Duration	Operation
-	-	Others	192.168.1.116		IP-COM_3D7DE0	5GHz	75dBm	1minute(s)	<input type="checkbox"/> Force Offline
iPhone-11-Pro-512G	-	Others	192.168.1.58		IP-COM_3D7DE0	5GHz	62dBm	0minute(s)	<input type="checkbox"/> Force Offline

### Parameter description

Parameter	Description
Online Users	Specifies the number of online devices.
Export	Used to export users' information to the local computer.
Force Offline	Used to kick the online users offline in batches.
Terminal Name	Specifies the name of the client.
Terminal Remark	Specifies the introduction to the client.
Terminal Type	Specifies the type of client such as smartphone, PAD and PC. If the client type is not recognized, <b>Others</b> will be displayed.
IP Address	Specifies the IP address of the client.
MAC Address	Specifies the MAC address of the client.
Associated Device	Specifies the information of the AP that the client connects to.
Associated Device Remark	Specifies the remark of the AP that the client connects to.
Associated Device IP Address	Specifies the IP address of the wireless network belonging to the AP that the client connects to.
Associated Device MAC Address	Specifies the MAC address of the wireless network belonging to the AP that the client connects to.

Parameter	Description
Associated SSID	Specifies the name of the wireless network to which the client connects, or the SSID.
Band	Specifies the frequency band of the wireless network to which the client connects. <ul style="list-style-type: none"><li>- <b>2.4 GHz:</b> The frequency band of the AP is <b>2.4 GHz</b>.</li><li>- <b>5 GHz:</b> The frequency band of the AP is <b>5 GHz</b>.</li></ul>
Real-time Upload	Specifies the real-time upload rate of the client.
Real-time Download	Specifies the real-time download rate of the client.
Total Traffic	Specifies the total download traffic during total client connection.
Signal Strength	Specifies the signal strength of the wireless network to which the client connects.
Online Duration	Specifies the duration during which the client is connected to the wireless network.
Operation	 <b>Force Offline</b> : Used to kick the online user offline.

## 6.8 Example of configuring fat APs

### Networking requirements

A hotel uses the enterprise router and fat AP to construct networks, in which they require that the networks accessed by guests and staff are isolated. Guests can access only the internet and staff can access only the intranet.

### Solution

- Successfully manage APs on the router and deliver different wireless policies to the APs.
- Configure an SSID policy for guests. Assume that the SSID is **internet**, wireless password is **UmXmL9UK** and VLAN ID is **20**.
- Configure an SSID policy for staff. Assume that the SSID is **oa**, wireless password is **CetTLb8T** and VLAN ID is **30**.
- Configure a VLAN forwarding rule on the switch.
- Configure a VLAN forwarding rule on the router and internal server.

The application scenarios are as follows.

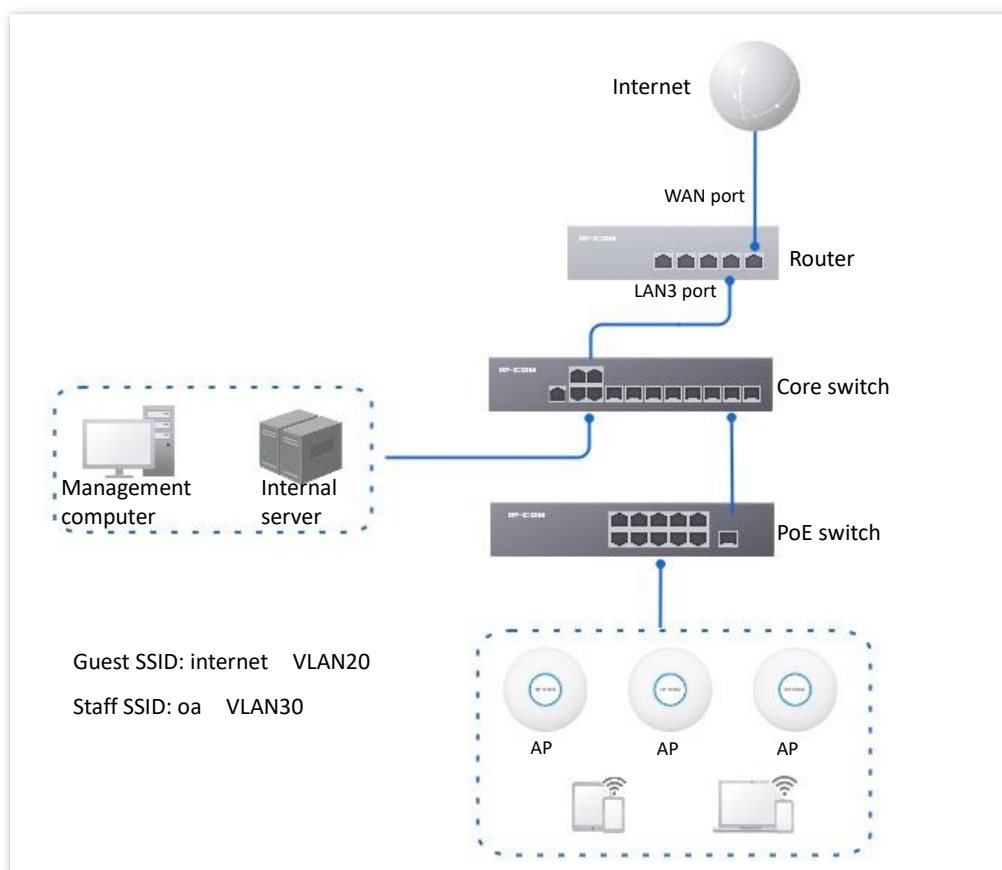

## Configuration procedure

Configure the router

Configure the core switch

Configure the internal server

### I. Configure the router.

1. [Log in to the web UI of the router.](#)
2. Manage APs (skip if performed).
  - 1) Navigate to **AP > AP Management Mode**.
  - 2) Enable the **AP Management Mode** and **Configuration Auto Delivery** functions.
  - 3) Click **Add**. Add the **AP\_DHCP\_Default** DHCP policy for the **VLAN\_Default** management port. By default, the system has created a DHCP policy for the management port. The following figure is for reference only.

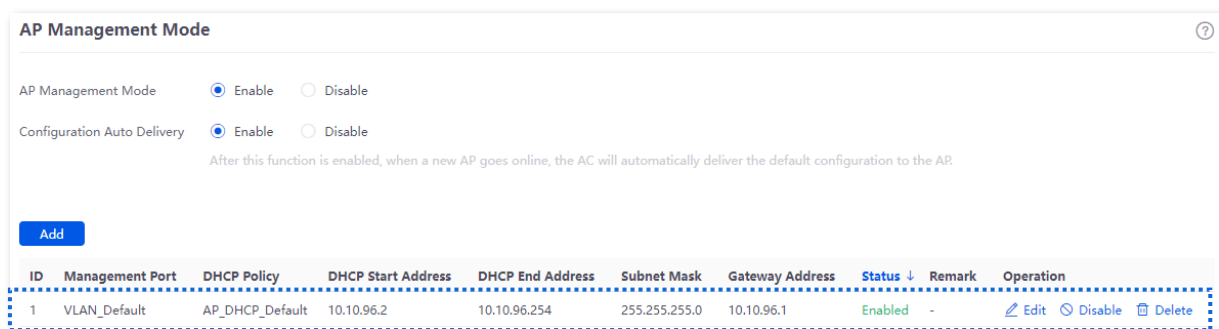

Navigate to **AP > AP List and Maintenance** to check whether the router manages the AP successfully.

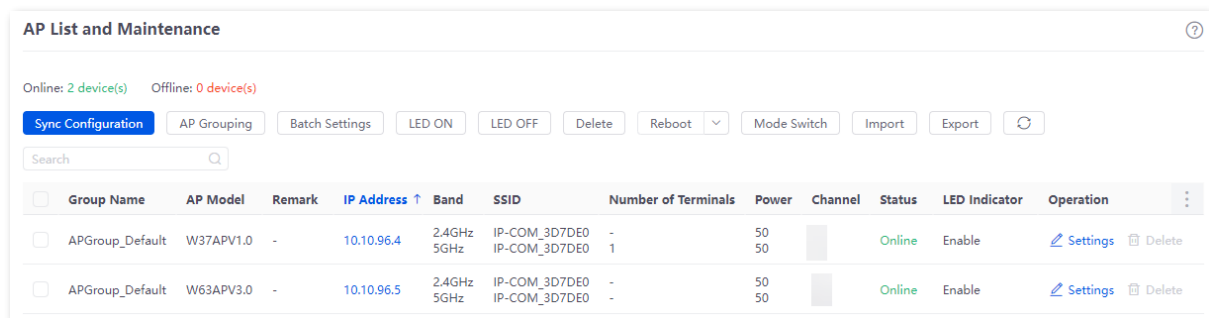

3. Add the VLAN and configure the DHCP server.

The following table lists the VLAN parameters for example.

VLAN Name	VLAN ID	IP Address/Network Segment	Physical Port
Guest	20	192.168.20.1/24	LAN3

The following table lists the DHCP server parameters of the VLAN for example.

Policy Name	Application Interface	DHCP Type	DHCP Configuration
Guest	<a href="#">Guest</a>	User DHCP	IP Address Pool: 192.168.20.100 - 192.168.20.200 Subnet Mask: 255.255.255.0 Gateway: 192.168.20.1 Primary DNS: 192.168.20.1
Guest1	<a href="#">Guest</a>	AP DHCP	IP Address Pool: 10.10.20.100 - 10.10.20.200 Subnet Mask: 255.255.255.0 Gateway: 10.10.20.1 Primary DNS: 10.10.20.1

1) Add VLANs.

Navigate to **Network > VLAN Settings**. Click **Add**, configure VLAN parameters and click **Save**.

VLAN Name	VLAN ID	IP Address	Subnet Mask ↑	Interface	Remark	Allow Access	Status	Operation
VLAN_Default	1	192.168.0.252	255.255.255.0	LAN1,LAN2,LAN3,LAN4	-	Allow	Enabled	<a href="#">Edit</a> <a href="#">Disable</a> <a href="#">Delete</a>
Guest	20	192.168.20.1	255.255.255.0	LAN3	-	Allow	Enabled	<a href="#">Edit</a> <a href="#">Disable</a> <a href="#">Delete</a>

2) Configure the DHCP server for the VLAN.

Navigate to **Network > DHCP Settings > DHCP Server**, and click **Add**. Configure parameters for the user DHCP server and AP DHCP server of the Guest VLAN and click **Save**.

Policy Name	DHCP Type	Interface	Client Address	Subnet Mask	Gateway	Primary DNS	Lease	Status	Remark	Operation
User_DHCP_Default	User DHCP	VLAN_Default	192.168.0.2-192.168.0.254	255.255.255.0	192.168.0.252	192.168.0.252	30min	Enabled	-	<a href="#">Edit</a> <a href="#">Disable</a> <a href="#">Delete</a>
AP_DHCP_Default	AP DHCP	VLAN_Default	10.10.96.2-10.10.96.254	255.255.255.0	10.10.96.1	10.10.96.1	30min	Enabled	-	<a href="#">Edit</a> <a href="#">Disable</a> <a href="#">Delete</a>
Guest	User DHCP	Guest	192.168.20.100-192.168.20.200	255.255.255.0	192.168.20.1	192.168.20.1	30min	Enabled	-	<a href="#">Edit</a> <a href="#">Disable</a> <a href="#">Delete</a>
Guest1	AP DHCP	Guest	10.10.20.100-10.10.20.200	255.255.255.0	10.10.20.1	10.10.20.1	30min	Enabled	-	<a href="#">Edit</a> <a href="#">Disable</a> <a href="#">Delete</a>

4. Deliver the AP DHCP policy to the Guest VLAN interface.

- 1) Navigate to **AP > AP Management Mode**.
- 2) Click **Add** to add the AP DHCP policy for the LAN3 port. The following figure is for reference only.

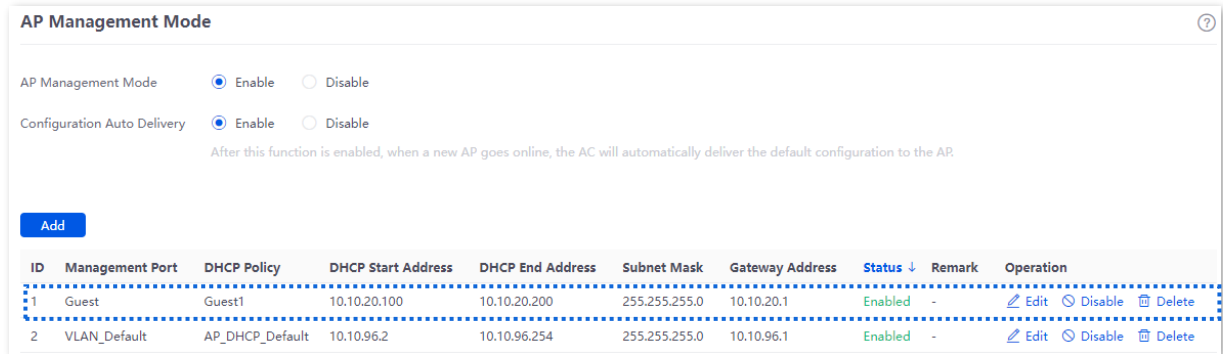

Navigate to **AP > AP List and Maintenance**, you can view that the IP address of the AP connected to the LAN3 port of the router belongs to the client address segment of the AP DHCP policy of the Guest VLAN.

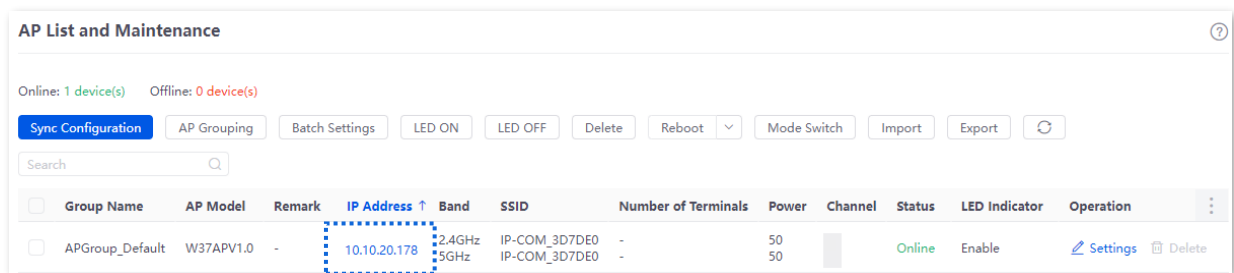

5. Configure the AP policy.

The following table provides examples of AP policy parameters. Retain default values for other parameters that are not mentioned.

SSID Policy	RF Policy	VLAN Policy	AP Group Policy
Policy Name: Guest SSID			Policy Name: Hotel
SSID: internet		Policy Name: AP VLAN	No. of SSIDs: 2
Security Mode/Encryption: WPA2-PSK/AES	RF_Default	AP VLAN: Enabled	2.4G/5G SSID1 Policy: <a href="#">Guest SSID</a>
Password: UmXmL9UK		Trunk port: LAN0	2.4G/5G SSID2 Policy: <a href="#">Staff SSID</a>
VLAN ID: 20			

SSID Policy	RF Policy	VLAN Policy	AP Group Policy
Policy Name: Staff SSID			RF Policy: RF_Default
SSID: oa			VLAN policy: AP VLAN
Security Mode/Encryption: WPA2-PSK/AES			
Password: CetTLb8T			
VLAN ID: 30			

1) Configure the SSID policy.

Navigate to **AP > Wireless Policy > SSID Policy**, click **Add** to configure related parameters of the SSID policy, and click **Save**.



The maximum number of clients supported by the AP is 128. If multiple SSID policies need to be delivered to the same AP, you should plan the maximum number of clients appropriately to ensure that the sum of the maximum number of clients for each SSID policy does not exceed 128.

Policy Name	SSID	Guest Network	Max. No. of Clients	Security Mode	Password	Hide SSID	Client Isolation	VLAN ID	Schedule Disable	Status	Remark	Operation
SSID1_Default	IP-COM_3D7DE0	Disable	48	None	-	Disable	Disable	1000	Disable	Used	-	<a href="#">Edit</a> <a href="#">Delete</a>
Guest SSID	internet	Disable	40	WPA2-PSK	UmXmL9UK	Disable	Disable	20	Disable	Not in Use	-	<a href="#">Edit</a> <a href="#">Delete</a>
Staff SSID	oa	Disable	40	WPA2-PSK	CetTLb8T	Disable	Disable	30	Disable	Not in Use	-	<a href="#">Edit</a> <a href="#">Delete</a>

2) Configure the VLAN policy.

Navigate to **AP > Wireless Policy > VLAN Policy**, and click **Add**. Enable **AP VLAN**, set **Trunk Port** and click **Save**.

Policy Name	AP VLAN	PVID	Management VLAN	Trunk Port	LAN Port	Status	Remark	Operation
AP VLAN	Enable	1	1	LAN0	LAN1:1	Not in Use	-	<a href="#">Edit</a> <a href="#">Delete</a>

3) Configure the AP group policy.

Navigate to **AP > AP Group Policy**, and click **Add**. Configure parameters as required, and click **Save**.



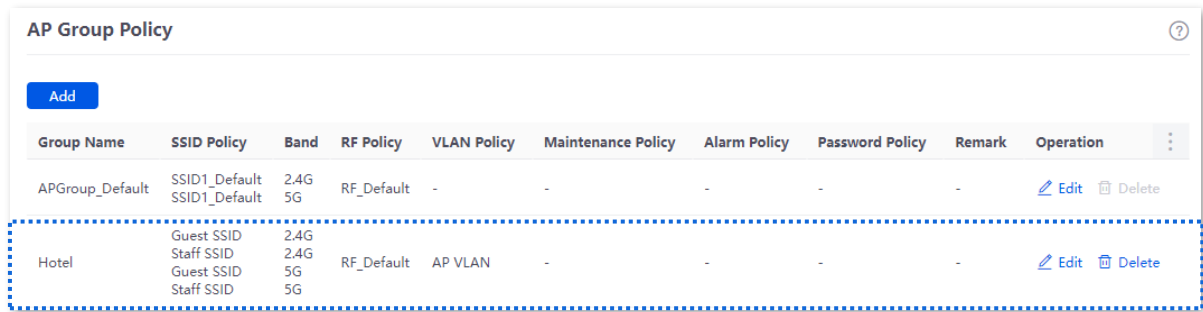

## 6. Deliver the AP group policy.

- 1) Navigate to **AP > AP List and Maintenance**. Select the AP to which the AP group policy is to be delivered, and click **AP Grouping**.

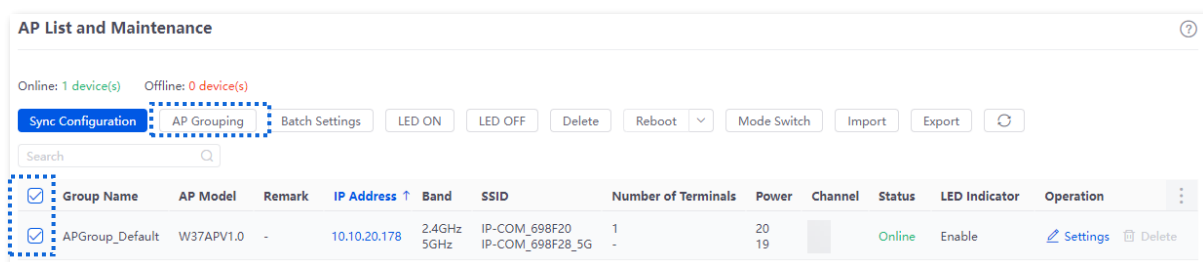

- 2) Select an AP group policy, which is **Hotel** in this example. Then, click **Save**.

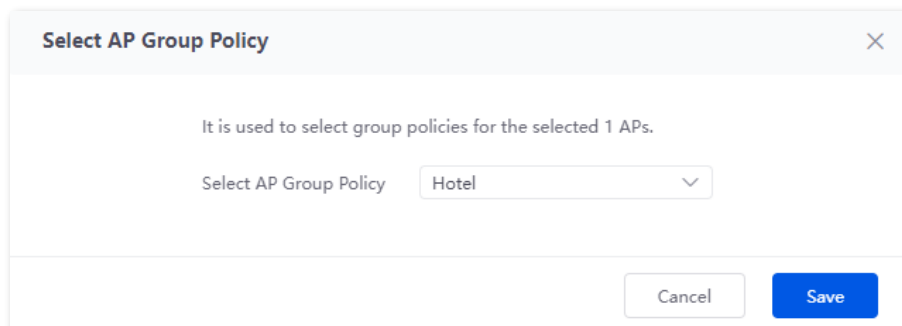

## II. Configure the core switch.

Divide the IEEE 802.1Q VLAN on the VLAN as follows.

Port Connected to	VLAN ID (VLAN Allowed to Pass)	Port Property	PVID
AP	20,30	Trunk	1
Router	20	Access	20
Internal server	30	Access	30

For other ports that are not mentioned, keep the default settings. For details about how to configure the switch, see the user guide of the switch.

### III. Configure the internal server.

Add the VLAN for the port connected to the switch and configure the DHCP server.

1. Add the VLAN. The parameters in the following table are for reference only.

VLAN Name	VLAN ID	IP Address/Network Segment	Physical Port	Port Property
Staff	30	192.168.30.1/24	LAN	Access

2. Configure the DHCP server for the VLAN. The parameters in the following table are for reference only.

VLAN Name	User DHCP
Staff	IP address pool: 192.168.30.100 - 192.168.30.200 Subnet mask: 255.255.255.0 Default gateway: 192.168.30.1 Primary DNS: 192.168.30.1

3. Set the VLAN connected to the port of the switch.

Port Connected to	VLAN ID (VLAN Allowed to Pass)	Port Property	PVID
Switch	30	Access	30

For details about how to configure the switch, see the user guide of the switch.

---End

## Verification

Users who connect to **internet** can access only the internet and users who connect to **oa** can access only the intranet.

## 6.9 IPTV

### 6.9.1 Overview

Internet Protocol Television (IPTV) is the technology integrating internet, multimedia, telecommunication and many other technologies to provide interactive services, including digital TV, for family users by internet broadband lines.

With the IPTV function, you can set up an IPTV data pass-through channel between the device and the AP to solve the difficult connection problem caused by the long distance between the IPTV set-top box and the optical modem.

If the IPTV service is included in your broadband service, you can enable the IPTV function of the router, then you can enjoy both internet access through the router and rich IPTV programs with a set-top box and TV.



This function needs to be used with IP-COM APs that support the IPTV function.

[Log in to the web UI of the router](#), and navigate to **AP > IPTV** to enter the page. This function is disabled by default. The following displays the page when the function is enabled.

#### Parameter description

Parameter	Description
IPTV Configuration IPTV Port	Used to designate a LAN port as the IPTV port to connect to the IPTV port of the modem. Refer to <a href="#">Port Information</a> on the <b>System</b> page for the LAN port number.

Parameter	Description
IPTV	Used to enable or disable the IPTV data pass-through function.
VLAN Configuration	<p>Specifies the VLAN ID of the IPTV service.</p> <ul style="list-style-type: none"> <li>– If the broadband service provider does not provide VLAN-related information when activating the IPTV service, select <b>General IPTV</b>, or select <b>Customize VLAN</b> and select <b>Without VLAN Tag</b>.</li> <li>– If the broadband service provider provides a <b>VLAN ID</b> when activating the IPTV service, select <b>Customize VLAN</b> and <b>With VLAN Tag</b>, and enter the corresponding <b>VLAN ID</b>.</li> </ul>
AP Model	Specifies the product model of the AP. Only APs that support IPTV are displayed in the AP list.
MAC Address	Specifies the MAC address of the AP.
Remark	Specifies the introduction of the AP.
AP List	<p>Specifies the wired Ethernet port on the AP to set up a transparent IPTV data transmission channel with the router. The designated Ethernet port needs to be connected to the IPTV set-top box.</p> <div style="display: flex; align-items: center; margin-top: 10px;"> <span style="font-size: 0.9em;">Tip</span> </div> <p style="margin-top: 10px;">The designated Ethernet port of the AP is <b>LAN1</b>.</p>

## 6.9.2 Watch IPTV programs (scenario 1)

### Networking requirements

The IPTV service is included in your broadband service. The ISP provides an IPTV user name and password, but no VLAN information.

Requirements: Watching IPTV programs.

### Solution

You can configure the IPTV function of the router to achieve the above requirements.

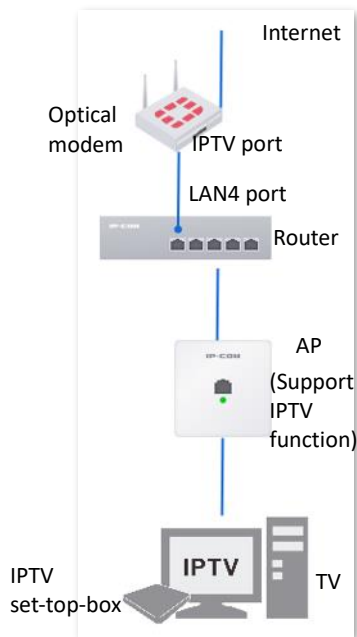

## Configuration procedure

1. Configure the router.
  - 1) [Log in to the web UI of the router.](#)
  - 2) Navigate to **AP > IPTV**.
  - 3) Enable the IPTV function and designate IPTV port.
    - Select the router as the LAN port of IPTV, which is **LAN4** in this example.
    - Enable the **IPTV** function.
    - Set **VLAN Configuration**, which is **General IPTV** in this example.
    - Click **Save**.

The screenshot shows the 'IPTV' configuration page in a web UI. The page title is 'IPTV'. Under the heading 'IPTV Configuration', there are three main sections: 'IPTV Port' with a dropdown menu set to 'LAN4'; 'IPTV' with radio buttons for 'Enable' (selected) and 'Disable'; and 'VLAN Configuration' with a dropdown menu set to 'General IPTV'. A blue 'Save' button is located at the bottom of the configuration area.

- 4) Designate AP as the wired Ethernet port of the IPTV port. The following figure is for reference only.
  - Choose the AP to be connected to the IPTV set-top box and click .

- Tick the **Designated Ethernet Port** and click **Save**.

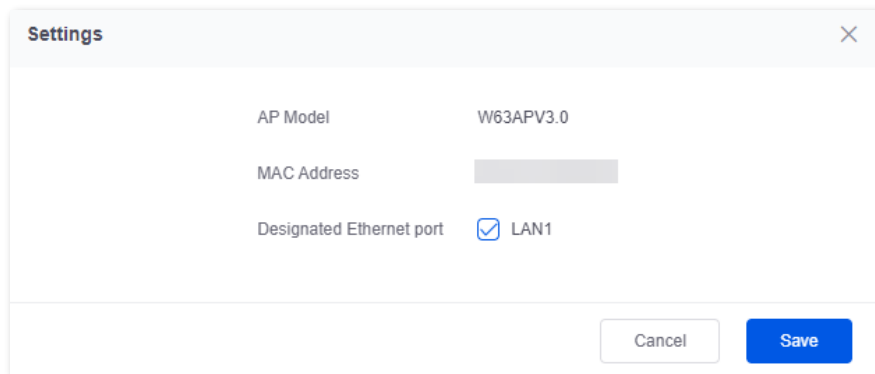

The image shows a 'Settings' dialog box with a close button (X) in the top right corner. It contains three configuration fields: 'AP Model' with the value 'W63APV3.0', 'MAC Address' with a greyed-out input field, and 'Designated Ethernet port' with a checked checkbox next to 'LAN1'. At the bottom right, there are two buttons: 'Cancel' and 'Save'.

The LAN1 port of the AP is designated successfully.

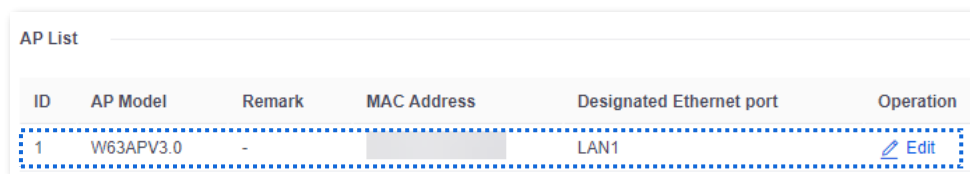

The image shows a table titled 'AP List' with the following columns: ID, AP Model, Remark, MAC Address, Designated Ethernet port, and Operation. The first row is highlighted with a dashed blue border and contains the values: 1, W63APV3.0, -, a greyed-out MAC address, LAN1, and an 'Edit' button with a pencil icon.

ID	AP Model	Remark	MAC Address	Designated Ethernet port	Operation
1	W63APV3.0	-		LAN1	Edit

2. Set your IPTV set-top box.

Use the IPTV user name and password provided by your ISP to dial up on your IPTV set-top box.

---End

## Verification

After the configuration is completed, you can watch IPTV programs on your TV.

### 6.9.3 Watch IPTV programs (scenario 2)

#### Networking requirements

The IPTV service is included in a hotel broadband service. The ISP provides an IPTV user name and password, and the VLAN ID of the IPTV service (VLAN ID 10 is taken as an example here).

Requirements: Watching IPTV programs and accessing the internet at the same time.

#### Solution

You can configure the IPTV function of the router, and the VLAN function of the switch to achieve the above requirements.

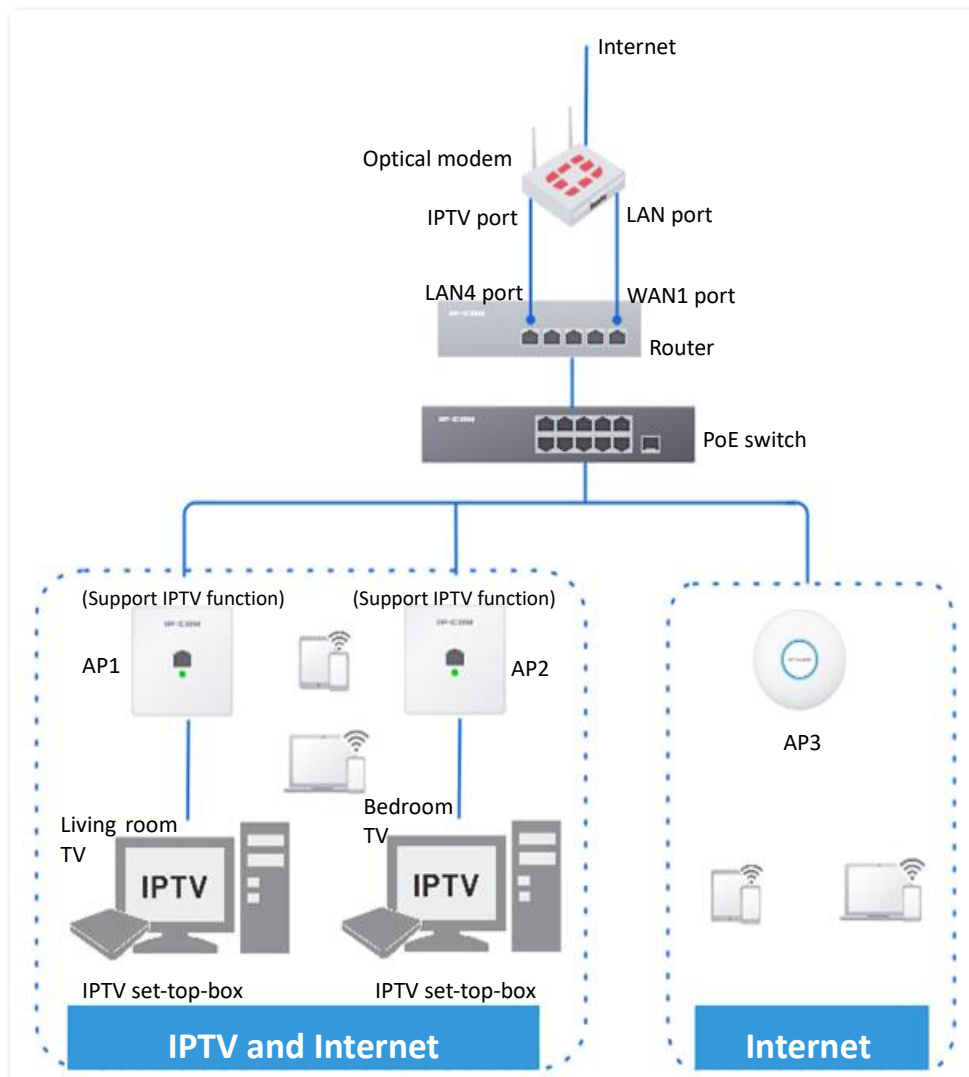

## Configuration procedure

1. Configure the router.
  - 1) [Log in to the web UI of the router.](#)
  - 2) Navigate to **AP > IPTV**.
  - 3) Enable the IPTV function of the router and designate the IPTV IN port.
    - Select the router as the LAN port of the IPTV IN port, which is **LAN4** in this example.
    - Enable the **IPTV** function.
    - Select **Customize VLAN** for **VLAN Configuration**, select **With VLAN Tag**, and enter **10** on **VLAN ID**.
    - Click **Save**.

**IPTV**

**IPTV Configuration**

IPTV Port: LAN4

IPTV:  Enable  Disable

VLAN Configuration: Customize VLAN

With VLAN Tag  Without VLAN Tag

VLAN ID: 10

Save

- 4) Designate a wired Ethernet port of the AP1 (support IPTV function).
  - Select the AP1 to be connected to the IPTV set-top box and click .
  - Tick the **Designated Ethernet Port** and click **Save**.

**Settings**

AP Model: W63APV3.0

MAC Address: [Greyed out]

Designated Ethernet port:  LAN1

Cancel Save

The LAN1 port of the AP is designated successfully.

ID	AP Model	Remark	MAC Address	Designated Ethernet port	Operation
1	W63APV3.0	-	[Greyed out]	LAN1	 Edit

- 5) Repeat [sub-step 4](#) of step 1 to designate other wired Ethernet port of AP2 (support IPTV function).
2. Set your IPTV set-top box.

Use the IPTV user name and password provided by your ISP to configure network settings on your IPTV set-top box.

---End



## **Verification**

You can watch IPTV programs and access the internet at the same time.

## 6.10 Wi-Fi optimization

### 6.10.1 Optimize wireless network

[Log in to the web UI of the router](#), and navigate to **AP > Wi-Fi Optimization** to enter the page.

On this page, you can optimize your wireless network and improve wireless network performance.

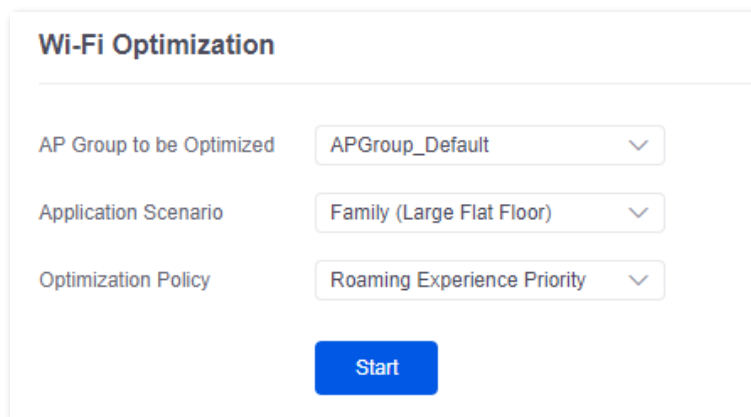

- There must be at least 2 APs in the AP group that support the Wi-Fi optimization function.
- After clicking **Start**, it cannot be paused or ended manually. Please wait until the system's automatic optimization.
- During the optimization process, the wireless network will be disconnected and the wireless client will temporarily drop offline. Please optimize when the network is relatively idle.

A screenshot of the "Wi-Fi Optimization" web interface. It features three dropdown menus: "AP Group to be Optimized" (set to "APGroup\_Default"), "Application Scenario" (set to "Family (Large Flat Floor)"), and "Optimization Policy" (set to "Roaming Experience Priority"). A blue "Start" button is positioned below the dropdowns.

#### Parameter description

Parameter	Description
AP Group to be Optimized	Used to select the AP group that needs to be optimized, and the APs in this group will be wirelessly optimized.
Application Scenario	Select the application scenario as required, including <b>Family (Large Flat Floor)</b> , <b>Family (Villa)</b> and <b>Enterprise Office</b> .

Parameter	Description
Optimization Policy	<p>Used to select an appropriate optimization policy.</p> <ul style="list-style-type: none"><li>- <b>Roaming Experience Priority:</b> Prioritize roaming experience. It can be used in scenarios with high AP deployment density, maximizing the roaming experience and ensuring that clients connect to APs with good signals, which may reduce the maximum coverage of the wireless network.</li><li>- <b>Coverage Priority:</b> Prioritize Wi-Fi coverage. It can be used in scenarios with low AP deployment density, maximizing coverage and ensuring that clients successfully connect to APs as much as possible, which may reduce the roaming sensitivity.</li></ul>

## 6.10.2 Schedule optimization

[Log in to the web UI of the router](#), and navigate to **AP > Wi-Fi Optimization > Schedule Optimization** to enter the page.

On this page, you can set the system to automatically optimize the wireless network periodically during idle time.







- There must be at least 2 APs in the AP group that support the Wi-Fi optimization function.
- During the optimization process, the wireless network will be disconnected and the wireless client will temporarily drop offline. Please optimize when the network is relatively idle.

AP Grouping	Application Scenario	Optimization Policy	Optimization Period	Schedule Optimization	Remark	Operation
APGroup_Default	Family (Large Flat Floor)	Roaming Experience Priority	Sun., 05:00	Disabled	Default	<a href="#">Edit</a> <a href="#">Enable</a> <a href="#">Delete</a>

By default, the system has created a schedule optimization policy named **APGroup\_Default**, which can be directly modified and enabled. You can click **Add** to create a new schedule optimization policy.

### Parameter description

Parameter	Description
AP Grouping	Used to select the AP group that needs to be optimized, and the APs in this group will be wirelessly optimized.
Schedule Optimization	Used to enable or disable the schedule optimization function.
Application Scenario	Select the application scenario as required, including <b>Family (Large Flat Floor)</b> , <b>Family (Villa)</b> and <b>Enterprise Office</b> .
Optimization Policy	Used to select an appropriate optimization policy. <ul style="list-style-type: none"> <li>- <b>Roaming Experience Priority:</b> Prioritize roaming experience. It can be used in scenarios with high AP deployment density, maximizing the roaming experience and ensuring that clients connect to APs with good signals, which may reduce the maximum coverage of the wireless network.</li> <li>- <b>Coverage Priority:</b> Prioritize Wi-Fi coverage. It can be used in scenarios with low AP deployment density, maximizing coverage and ensuring that clients successfully connect to APs as much as possible, which may reduce the roaming sensitivity.</li> </ul>
Time/Optimization Period	Specify the time and date when the APs automatically reboot.
Repeat	

Parameter	Description
Remark	Specifies the introduction to the schedule optimization policy. The remark is optional.
Operation	Used to edit, enable, disable or delete the schedule optimization policy.  <b>Edit</b> : Used to modify the schedule optimization policy.  <b>Enable</b> : Used to enable the schedule optimization policy.  <b>Disable</b> : Used to disable the schedule optimization policy.  <b>Delete</b> : Used to delete the schedule optimization policy.

### 6.10.3 View Wi-Fi optimization record

[Log in to the web UI of the router](#), and navigate to **AP > Wi-Fi Optimization > Wi-Fi Optimization Record** to enter the page.

On this page, you can view the Wi-Fi optimization records, including the channel, power, co-channel interference number, adjacent-channel interference number and the total number of interference before and after the AP wireless network optimization.

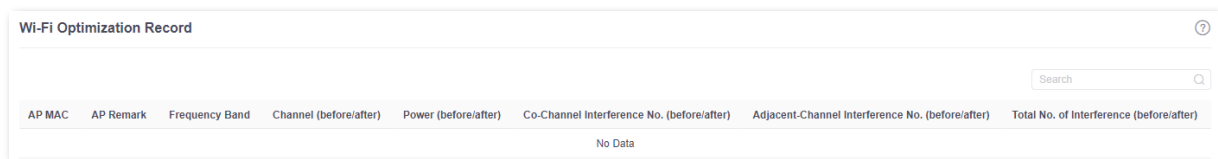

# 7 Authentication

## 7.1 Overview

By default, when the router is connected to the internet, the LAN users can access the internet. With the Authentication function enabled, clients connected to the authentication network can access the internet only after successful authentication. If a client is reconnected to the router after successful authentication, the client may be required to perform authentication again. The guest policies of this router take effect based on the VLAN interface.

After the local server authentication is enabled, the user authentication is completed on the local router. The authentication users are saved on the local router and the portal customization is also generated on the local router. The local authentication types supported by the router include [SMS](#), [Email](#), [Account](#), [No Authentication](#), [PPPoE](#) and [Random Code](#).

The working principle of local authentication is as follows.

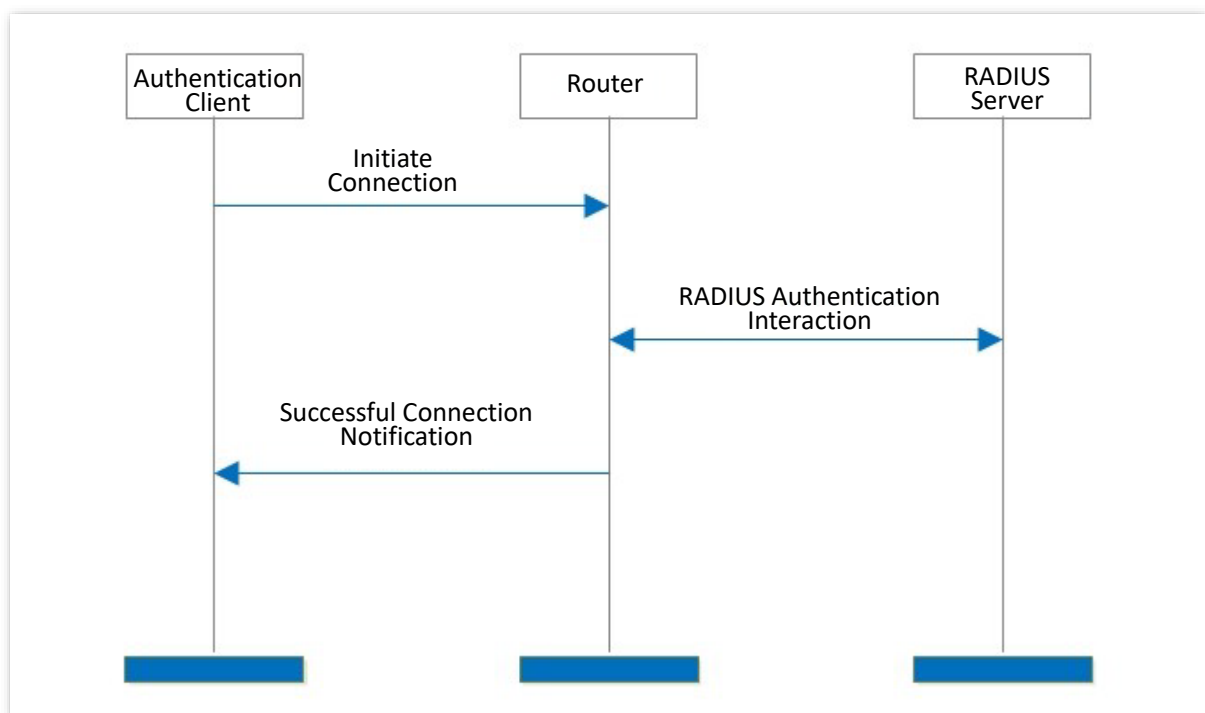

1. The authentication client uses HTTP to initiate a connection request.
2. The router will request redirection to the local portal customization, and the user enters the user name and password on the portal customization.

3. Based on the user name and password, the router performs RADIUS authentication interaction with RADIUS server for user authentication and charging.
4. The router notifies the authentication client that the online connection is successful.

## 7.2 Configuration wizard

Procedure	Task	Description
1	<a href="#">Configure authentication templates</a>	Required. Manually create a portal customization.
2	<a href="#">Configure authentication type</a>	Required. Configure one or multiple authentication types based on actual requirements.
3	<a href="#">Configure time policy</a>	Required. Configure the time policy based on actual requirements.
4	<a href="#">Configure guest policies</a>	Required.
5	<a href="#">Configure authentication account</a>	Optional. If the <b>Authentication Type</b> is <b>Account</b> , <b>PPPoE</b> or <b>Random Code</b> , the authentication account must be configured.
6	<a href="#">Configure authentication-free hosts</a>	Optional. To enable the devices to connect to the internet without authentication, the authentication-free host must be configured.



**Tip**  
If PPPoE authentication is configured, the authentication template and time policy do not need to be configured.



## 7.3 Configure authentication templates



### 7.3.1 Image template

The image template can be used for SMS authentication, email authentication, account authentication, no authentication and random code authentication. An image template has been preset in the system. You can edit based on the preset template or create a new one.

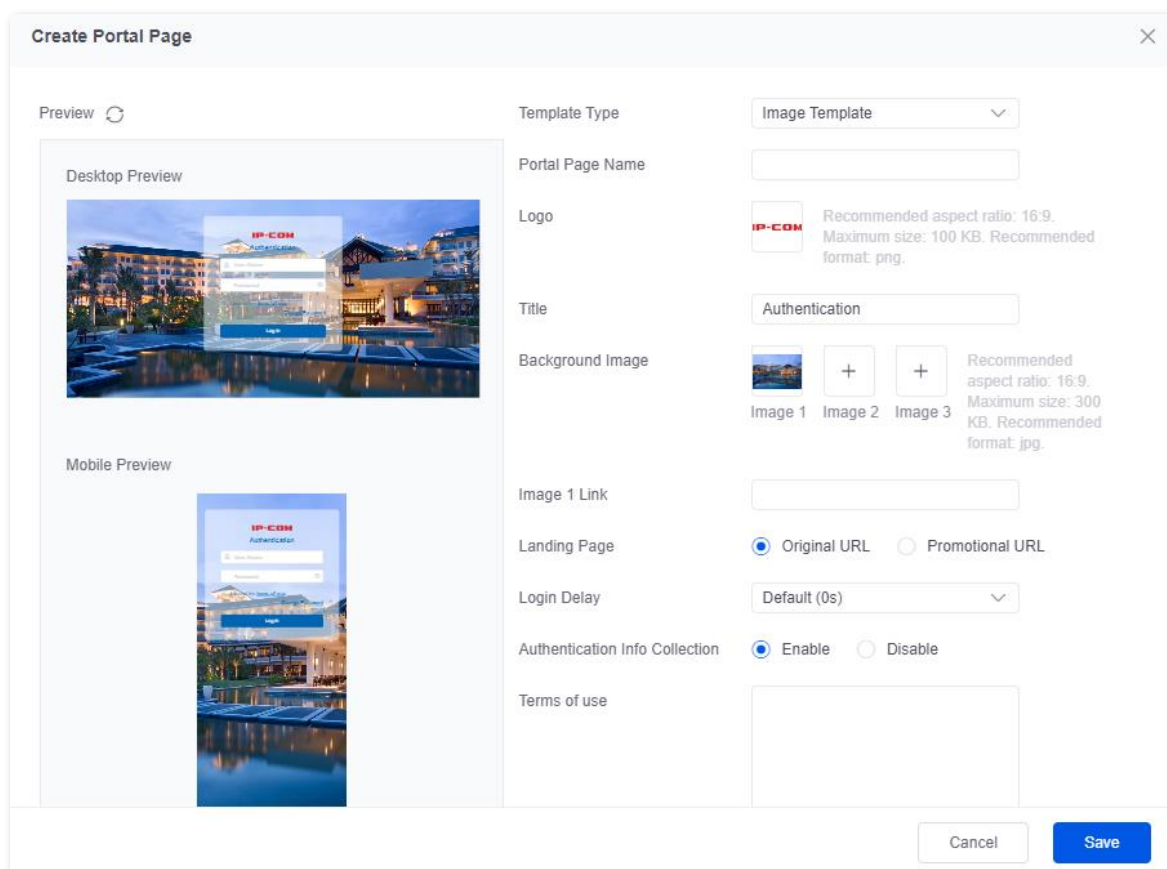
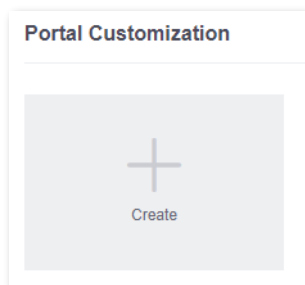
To add an image template, [log in to the web UI of the router](#), navigate to **AuthN > Authentication Template > Portal Customization**, and click **Create**.

A screenshot of the 'Create Portal Page' configuration window. The window is divided into a preview area on the left and a configuration area on the right. The preview area shows a desktop and mobile view of a login page with a background image of a building at night. The configuration area includes fields for Template Type (Image Template), Portal Page Name, Logo, Title (Authentication), Background Image (with three image slots), Image 1 Link, Landing Page (Original URL selected), Login Delay (Default (0s)), Authentication Info Collection (Enable selected), and Terms of use. There are 'Cancel' and 'Save' buttons at the bottom right.

## Parameter description

Parameter	Description
Preview	 : Used to refresh the preview pages.
Template Type	Specifies the type of template, including <b>Image Template</b> and <b>Text Template</b> .
Portal Page Name	Specifies the name of the portal page. The name is required.
Logo	Specifies the logo image of the portal page. By default, the logo image is <b>IP-COM</b> . You can click it to change the logo image.
Title	Specifies the title information of the portal page. By default, the title is <b>Authentication</b> .
Background Image	<p>Specifies the background images of the portal page. You can upload at most three images.</p> <p> <b>Tip</b></p> <ul style="list-style-type: none"> <li>- This parameter is available only when the <b>Template Type</b> is set to <b>Image Template</b>.</li> <li>- When two or three background images are uploaded, the images will be displayed in turn on the portal page.</li> </ul>
Image 1 Link/ Image 2 Link/ Image 3 Link	<p>Specifies the URL linked to the corresponding background image. After the configuration is completed, you can access the website by clicking the corresponding background image on the portal page.</p> <p> <b>Note</b></p> <ul style="list-style-type: none"> <li>- This parameter is available only when the <b>Template Type</b> is set to <b>Image Template</b>.</li> <li>- The link must be an http URL, otherwise, the function will not take effect.</li> </ul>
Landing Page	<p>Specifies the web address that users are automatically redirected to after passing the authentication.</p> <ul style="list-style-type: none"> <li>- <b>Original URL:</b> After users pass the authentication, the browser redirects to the website that users visited before the authentication. For example, if the user is visiting Google when being redirected to the portal page, the user will be redirected back to Google after passing the authentication.</li> <li>- <b>Promotional URL:</b> After users pass the authentication, the browser redirects to the address specified here.</li> </ul>
Login Delay	Specifies the delay time before login. By default, the delay time is <b>Default (0s)</b> .
Authentication Info Collection	Used to enable or disable the authentication information collection function.

Parameter	Description
Terms of use	Specifies the disclaimer information on the web portal page. Users must agree and tick the disclaimer before logging in.

---

## 7.3.2 Text template

The text template can be used for SMS authentication, email authentication, account authentication, no authentication and random code authentication. You can create a text template for authentication as required.



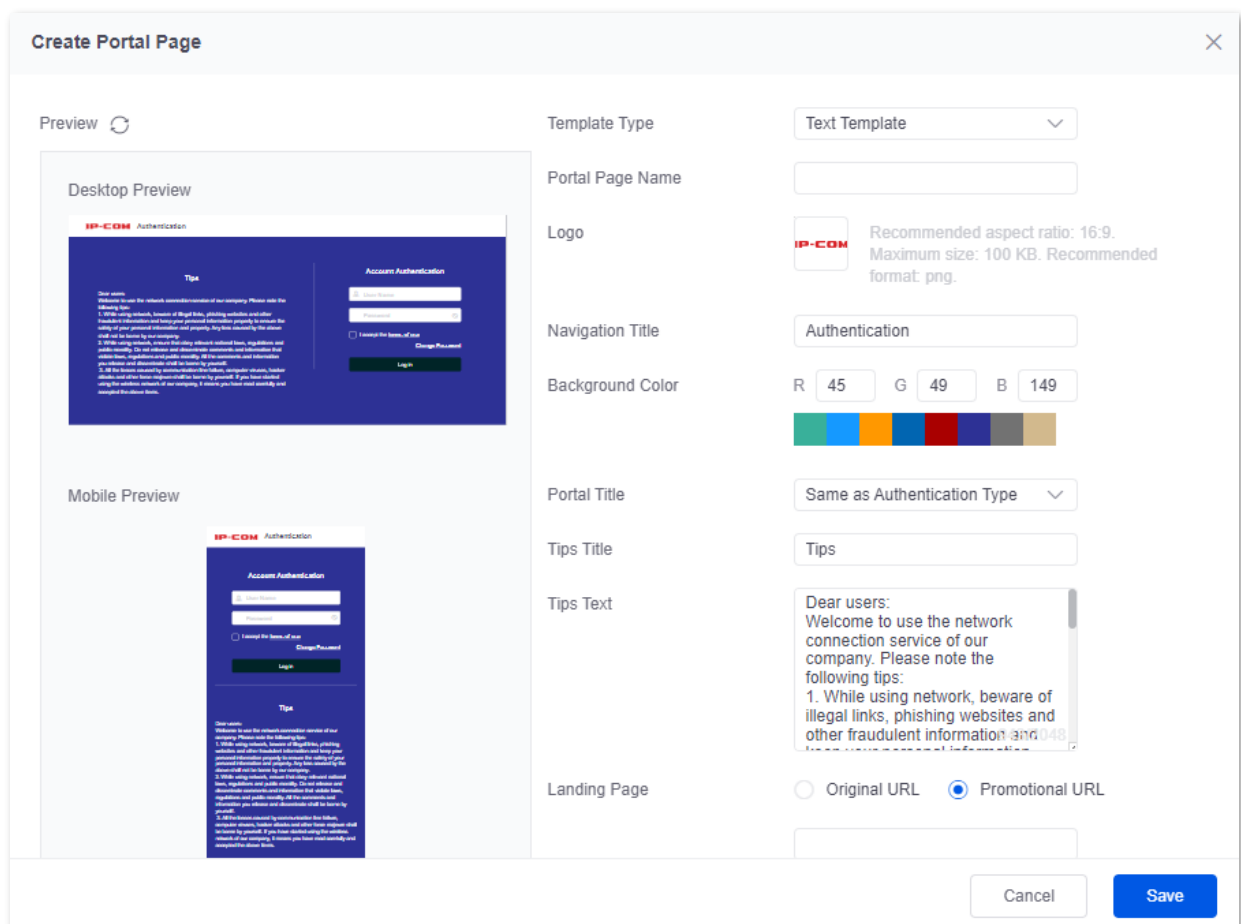
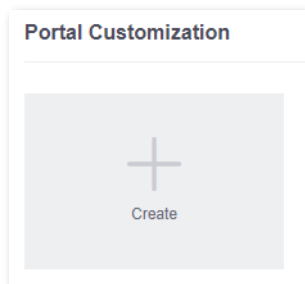

To add a text template, [log in to the web UI of the router](#), navigate to **AuthN > Authentication Template > Portal Customization**, and click **Create**.

A screenshot of the 'Create Portal Page' configuration window. The window is divided into several sections:

- Preview:** Shows a desktop and mobile preview of the authentication page. The desktop preview shows a dark blue background with a 'Tips' section on the left and an 'Account Authentication' form on the right. The mobile preview shows the same content adapted for a smaller screen.
- Template Type:** A dropdown menu set to 'Text Template'.
- Portal Page Name:** An empty text input field.
- Logo:** A small IP-COM logo icon. To its right, text reads: 'Recommended aspect ratio: 16:9. Maximum size: 100 KB. Recommended format: png.'
- Navigation Title:** A text input field containing the word 'Authentication'.
- Background Color:** A color picker showing RGB values: R 45, G 49, B 149. Below the values are color swatches for red, green, blue, yellow, cyan, magenta, and grey.
- Portal Title:** A dropdown menu set to 'Same as Authentication Type'.
- Tips Title:** A text input field containing the word 'Tips'.
- Tips Text:** A text area containing the following text: 'Dear users: Welcome to use the network connection service of our company. Please note the following tips: 1. While using network, beware of illegal links, phishing websites and other fraudulent information and 048'.
- Landing Page:** Two radio buttons: 'Original URL' (unselected) and 'Promotional URL' (selected).

At the bottom right, there are 'Cancel' and 'Save' buttons.

## Parameter description

Parameter	Description
Preview	 : Used to refresh the preview pages.
Template Type	Specifies the type of template, including <b>Image Template</b> and <b>Text Template</b> .
Portal Page Name	Specifies the name of the portal page. The name is required.
Logo	Specifies the logo image of the portal page. By default, the logo image is <b>IP-COM</b> . You can click it to change the logo image.
Navigation Title	Specifies the title information of the portal page. By default, the title is <b>Authentication</b> .
Background Color	<p>Specifies the background color. You can enter an RGB value or select one from the given colors.</p> <p> Tip</p> <p>This parameter is available only when the <b>Template Type</b> is set to <b>Text Template</b>.</p>
Portal Title	<p>Specifies the title of the portal page, including <b>Same as Authentication Type</b> and <b>Customize</b>.</p> <ul style="list-style-type: none"><li>- <b>Same as Authentication Type</b>: The name is the same as the authentication type. For example, if this template is used for account authentication, the authentication title will be <b>Account</b>.</li><li>- <b>Customize</b>: You can customize a portal title here.</li></ul>
Tips Title	<p>Specifies the tip title on the portal page. By default, the title is <b>Tips</b>.</p> <p> Tip</p> <p>This parameter is available only when the <b>Template Type</b> is set to <b>Text Template</b>.</p>
Tips Text	<p>Specifies the tip content on the portal page.</p> <p> Tip</p> <p>This parameter is available only when the <b>Template Type</b> is set to <b>Text Template</b>.</p>

Parameter	Description
Landing Page	<p>Specifies the web address that users are automatically redirected to after passing the authentication.</p> <ul style="list-style-type: none"><li>– <b>Original URL:</b> After users pass the authentication, the browser redirects to the website that users visited before the authentication. For example, if the user is visiting Google when being redirected to the portal page, the user will be redirected back to Google after passing the authentication.</li><li>– <b>Promotional URL:</b> After users pass the authentication, the browser redirects to the address specified here.</li></ul>
Login Delay	Specifies the delay time before login. By default, the delay time is <b>Default (0s)</b> .
Authentication Info Collection	Used to enable or disable the authentication information collection function.
Terms of use	Specifies the disclaimer information on the web portal page. Users must agree and tick the disclaimer before logging in.

## 7.4 Configure authentication type

### 7.4.1 Overview

[Log in to the web UI of the router](#), and navigate to **AuthN > Authentication Template > Authentication Type**, you can configure the authentication type according to the actual requirements. The authentication types include **SMS, Email, Account, No Authentication, PPPoE** and **Random Code**.

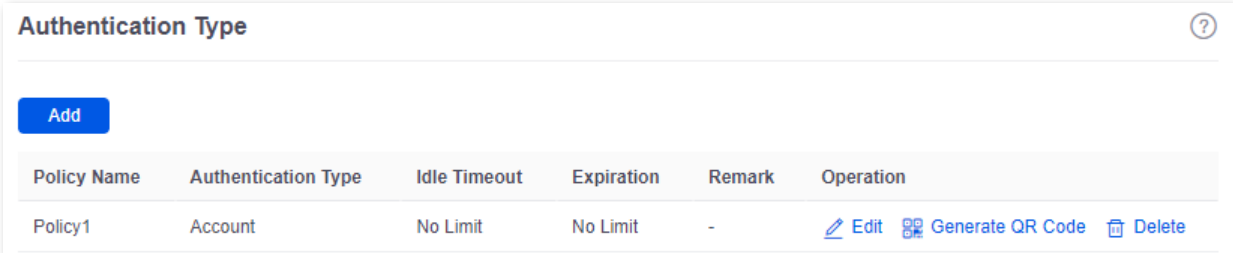

Policy Name	Authentication Type	Idle Timeout	Expiration	Remark	Operation
Policy1	Account	No Limit	No Limit	-	<a href="#">Edit</a> <a href="#">Generate QR Code</a> <a href="#">Delete</a>

#### Parameter description

Parameter	Description
Policy Name	Specifies the policy name of the authentication type.
Authentication Type	Specifies the type of the authentication.
Idle Timeout	Specifies the idle timeout of the authentication. If there is no operation within the idle timeout after successful authentication, you need to authenticate again to access the internet.
Expiration	Specifies the validity period of authentication. If the internet access expires after successful authentication, you need to re-authenticate to access the internet.
Remark	Specifies the introduction to the authentication. The remark is optional.
Operation	Used to edit or delete the policy of the authentication type. <a href="#">Edit</a> : Used to modify the policy. <a href="#">Generate QR Code</a> : Used to generate the QR code, which you can scan to access the portal page. <a href="#">Delete</a> : Used to delete the policy.

## 7.4.2 SMS

After the **SMS** authentication is enabled, you need to enter a valid mobile phone number on the portal customization to obtain a verification code for authentication. After successful authentication, you can access the internet.

The SMS providers issues the authorization verification code to the specified mobile phone number. Currently, the preset SMS providers include **Tencent Cloud**, **AliCloud**, **Jixintong** and **NEXMO**. Meanwhile, **Customize HTTP Interconnection** is also supported if you want to use other SMS providers.



You need to subscribe to an SMS package from an SMS provider before performing corresponding configurations on the router.

To add an SMS authentication type, [log in to the web UI of the router](#), navigate to **AuthN > Authentication Template > Authentication Type**, and click **Add**.

**Add Authentication Type**

Policy Name

Authentication Type

WeChat Privilege Time  min ⓘ  
The period for which users can use WeChat before authentication. 0 indicates that users are not allowed to use WeChat.

Idle Timeout  min ⓘ  
If there is no operation within the idle timeout, users need to authenticate again to access the internet.

Expiration  min ⓘ  
After the online duration exceeds the authentication validity period, users need to authenticate again to access the internet.

SMS Provider

adkappid

adkappkey

Signature

Template ID

Validity Test     
Enter the country/region code and mobile number.  
Write an SMS in the following format when using Tencent Cloud. Otherwise, the SMS may fail to be sent:  
Hello. Your verification code is {1}. Verify within {2} minutes.

Remark  (Optional)

\*The interconnection information of different SMS providers is different. When you apply for the SMS packages, you can obtain the corresponding interconnection information and fill it here.



## Parameter description

Parameter	Description
Policy Name	Specifies the policy name of the authentication type.
Authentication Type	Specifies the authentication type. Select <b>SMS</b> from the drop-down menu.
WeChat Privilege Time	Specifies the duration for which users can use WeChat before authentication. <b>0</b> indicates that users are not allowed to use WeChat before authentication.
Idle Timeout	Specifies the idle timeout of the authentication. If there is no operation within the <b>Idle Timeout</b> after successful authentication, you need to authenticate again to access the internet.
Expiration	Specifies the validity period of authentication. If the internet access expires after successful authentication, you need to re-authenticate to access the internet.
Validity Test	Used to check whether the router is connected to the SMS provider. Enter the mobile phone number and click <b>Test</b> . If the connection is successful, the mobile phone number will receive a message with the verification code.
Remark	Specifies the introduction to the authentication. The remark is optional.

### 7.4.3 Email

After the **Email** authentication is enabled, you need to enter an Email address on the portal customization to obtain a verification code for authentication. After successful authentication, you can access the internet.

To add an Email authentication type, [log in to the web UI of the router](#), navigate to **AuthN > Authentication Template > Authentication Type**, and click **Add**.

The screenshot shows a dialog box titled "Add Authentication Type" with a close button (X) in the top right corner. The dialog contains the following fields and options:

- Policy Name:** A text input field.
- Authentication Type:** A dropdown menu with "Email" selected.
- WeChat Privilege Time:** A text input field with "0" and a "min" unit. A help icon is present. Below it, a note states: "The period for which users can use WeChat before authentication. 0 indicates that users are not allowed to use WeChat."
- Idle Timeout:** A dropdown menu with "No Limit" selected and a "min" unit. A help icon is present. Below it, a note states: "If there is no operation within the idle timeout, users need to authenticate again to access the internet."
- Expiration:** A dropdown menu with "No Limit" selected and a "min" unit. A help icon is present. Below it, a note states: "After the online duration exceeds the authentication validity period, users need to authenticate again to access the internet."
- No. of Shared Users:** A text input field with "1" and a help icon.
- Email:** A text input field.
- Email Password:** A text input field with a password icon.
- SMTP Server:** A text input field.
- SMTP Server Port:** A text input field.
- Validity Test:** A text input field with "Enter an Email address" and a "Test" button.
- Email Content:** A text area containing "[Verification Code] Your verification code for internet access is \$\$CODE\$\$." Below it, a note states: "The verification code is \$\$CODE\$\$." and a "75/256" character count is shown.
- Remark:** A text input field with "(Optional)" next to it.

At the bottom right of the dialog, there are "Cancel" and "Save" buttons.

#### Parameter description

Parameter	Description
Policy Name	Specifies the policy name of the authentication type.
Authentication Type	Specifies the authentication type. Select <b>Email</b> from the drop-down menu.

Parameter	Description
WeChat Privilege Time	Specifies the duration for which users can use WeChat before authentication. <b>0</b> indicates that users are not allowed to use WeChat before authentication.
Idle Timeout	Specifies the idle timeout of the authentication. If there is no operation within the <b>Idle Timeout</b> after successful authentication, you need to authenticate again to access the Internet.
Expiration	Specifies the validity period of authentication. If the internet access expires after successful authentication, you need to re-authenticate to access the internet.
No. of Shared Users	Specifies the number of shared users allowed to access the internet through Email authentication at the same time.
Email	Specify the account and password used to send verification code mails.
Email Password	
SMTP Server	Specify the SMTP server address or port.
SMTP Server Port	The Simple Mail Transfer Protocol (SMTP) server is a proxy server for sending mails. The SMTP server addresses and ports of each mail server provider are different, so the user needs to query them by themselves.
Validity Test	Used to check whether the router is connected to the mail server. Enter the Email address and click <b>Test</b> . If the connection is successful, the Email box will receive a verification code.
Email Content	Specifies the content of the verification code Email.
Remark	Specifies the introduction to the authentication. The remark is optional.

## 7.4.4 Account

After **Account** is enabled, you need to enter the user name and password on the portal customization. After successful authentication, you can access the internet. The user name and password should be configured in [Account Management](#) in advance.

To add a password authentication type, [log in to the web UI of the router](#), navigate to **AuthN > Authentication Template > Authentication Type**, and click **Add**.

**Add Authentication Type**

Policy Name

Authentication Type

WeChat Privilege Time  min ⓘ  
The period for which users can use WeChat before authentication. 0 indicates that users are not allowed to use WeChat.

Idle Timeout  min ⓘ  
If there is no operation within the idle timeout, users need to authenticate again to access the internet.

Expiration  min ⓘ  
After the online duration exceeds the authentication validity period, users need to authenticate again to access the internet.

Change Password upon First Login  Enable  Disable

Remark  (Optional)

### Parameter description

Parameter	Description
Policy Name	Specifies the policy name of the authentication type.
Authentication Type	Specifies the authentication type. Select <b>Account</b> from the drop-down menu.
WeChat Privilege Time	Specifies the duration for which users can use WeChat before authentication. <b>0</b> indicates that users are not allowed to use WeChat before authentication.
Idle Timeout	Specifies the idle timeout of the authentication. If there is no operation within the <b>Idle Timeout</b> after successful authentication, you need to authenticate again to access the internet.
Expiration	Specifies the validity period of authentication. If the internet access expires after successful authentication, you need to re-authenticate to access the internet.

Parameter	Description
Change Password upon First Login	Used to enable or disable the change password upon first login function. After this function is enabled, the user needs to change the password to access the internet after the first successful authentication.
Remark	Specifies the introduction to the authentication. The remark is optional.

## 7.4.5 No authentication

After **No Authentication** is enabled, you only need to click **Connect** on the pop-up portal customization to access the internet.

To add a one-key authentication type, [log in to the web UI of the router](#), navigate to **AuthN > Authentication Template > Authentication Type**, and click **Add**.

**Add Authentication Type** ✕

Policy Name

Authentication Type No Authentication ▼

WeChat Privilege Time  min ⓘ  
The period for which users can use WeChat before authentication. 0 indicates that users are not allowed to use WeChat.

Idle Timeout No Limit ▼ min ⓘ  
If there is no operation within the idle timeout, users need to authenticate again to access the internet.

Expiration No Limit ▼ min ⓘ  
After the online duration exceeds the authentication validity period, users need to authenticate again to access the internet.

Remark  (Optional)

### Parameter description

Parameter	Description
Policy Name	Specifies the policy name of the authentication type.
Authentication Type	Specifies the authentication type. Select <b>No Authentication</b> from the drop-down menu.
WeChat Privilege Time	Specifies the duration for which users can use WeChat before authentication. <b>0</b> indicates that users are not allowed to use WeChat before authentication.

Parameter	Description
Idle Timeout	Specifies the idle timeout of the authentication. If there is no operation within the <b>Idle Timeout</b> after successful authentication, you need to authenticate again to access the internet.
Expiration	Specifies the validity period of authentication. If the internet access expires after successful authentication, you need to re-authenticate to access the internet.
Remark	Specifies the introduction to the authentication. The remark is optional.

## 7.4.6 PPPoE

After the **PPPoE** authentication is enabled, the router is configured as a PPPoE server. You need to access the internet through broadband dial-up authentication. The PPPoE user name and password need to be configured in [Account Management](#) in advance.

To add a PPPoE authentication type, [log in to the web UI of the router](#), navigate to **AuthN > Authentication Template > Authentication Type**, and click **Add**.

The screenshot shows a configuration window titled "Add Authentication Type" with a close button (X) in the top right corner. The window contains the following fields and options:

- Policy Name: Text input field.
- Authentication Type: Dropdown menu set to "PPPoE".
- Client Isolation: Radio buttons for "Enable" and "Disable", with "Disable" selected.
- LCP Detection Interval: Text input field with "30" and a unit "s".
- LCP Detection Failure Attempts: Text input field with "10" and a help icon (i).
- PPPoE Server Name: Text input field.
- PPPoE Server IP: IP address input field with "10 . 66 . 66 . 100".
- Client Start IP Address: IP address input field with "10 . 66 . 66 . 101".
- Client End IP Address: IP address input field with "10 . 66 . 66 . 251".
- Primary DNS: IP address input field with "10 . 66 . 66 . 100".
- Secondary DNS: IP address input field with "." . "." . "." and "(Optional)" label.
- Remark: Text input field with "(Optional)" label.

At the bottom right, there are "Cancel" and "Save" buttons.

## Parameter description

Parameter	Description
Policy Name	Specifies the policy name of the authentication type.
Authentication Type	Specifies the authentication type. Select <b>PPPoE</b> from the drop-down menu.
Client Isolation	Used to enable or disable the client isolation function. With <b>Client Isolation</b> enabled, clients cannot access each other.
LCP Detection Interval	Specifies the interval at which PPPoE sends Link Control Protocol (LCP) packets.
LCP Detection Failure Attempts	Specifies the limit of failure attempts of the LCP Detection. When the number of unreplied LCP packets reaches the limit, the PPPoE server will disconnect the connection automatically.
PPPoE Server Name	Specifies the name of the customized PPPoE server.
PPPoE Server IP	Specifies the IP address of the customized PPPoE server. It is also the gateway address of the client and must be in the same network segment with the address pool of the client.
Client Start IP Address	Specify the start or end IP address that the PPPoE server assigns to clients.
Client End IP Address	
Primary DNS	Specify the IP addresses of primary and secondary DNS servers assigned by the PPPoE server to users. <b>Secondary DNS</b> is optional.
Secondary DNS	 <b>Note</b> To provide normal internet access, ensure that <b>Primary DNS</b> is set to the IP address of a correct DNS server or proxy.
Remark	Specifies the introduction to the authentication. The remark is optional.

## 7.4.7 Random code

After the **Random Code** authentication is enabled, you need to enter the random code on the portal customization to obtain a verification code for authentication. After successful authentication, you can access the internet. The random codes need to be configured in random code account in advance.

To add a random code authentication type, [log in to the web UI of the router](#), navigate to **AuthN > Authentication Template > Authentication Type**, and click **Add**.

**Add Authentication Type**

Policy Name

Authentication Type

WeChat Privilege Time  min ⓘ  
The period for which users can use WeChat before authentication. 0 indicates that users are not allowed to use WeChat.

Idle Timeout  min ⓘ  
If there is no operation within the idle timeout, users need to authenticate again to access the internet.

Expiration  min ⓘ  
After the online duration exceeds the authentication validity period, users need to authenticate again to access the internet.

Remark  (Optional)

### Parameter description

Parameter	Description
Policy Name	Specifies the policy name of the authentication type.
Authentication Type	Specifies the authentication type. Select <b>Random Code</b> from the drop-down menu.
WeChat Privilege Time	Specifies the duration for which users can use WeChat before authentication. <b>0</b> indicates that users are not allowed to use WeChat before authentication.
Idle Timeout	Specifies the idle timeout of the authentication. If there is no operation within the <b>Idle Timeout</b> after successful authentication, you need to authenticate again to access the Internet.
Expiration	Specifies the validity period of authentication. If the internet access expires after successful authentication, you need to re-authenticate to access the internet.
Remark	Specifies the introduction to the authentication. The remark is optional.



## 7.5 Configure guest policy

[Log in to the web UI of the router](#), and navigate to **AuthN > Guest Policies** to enter the page.



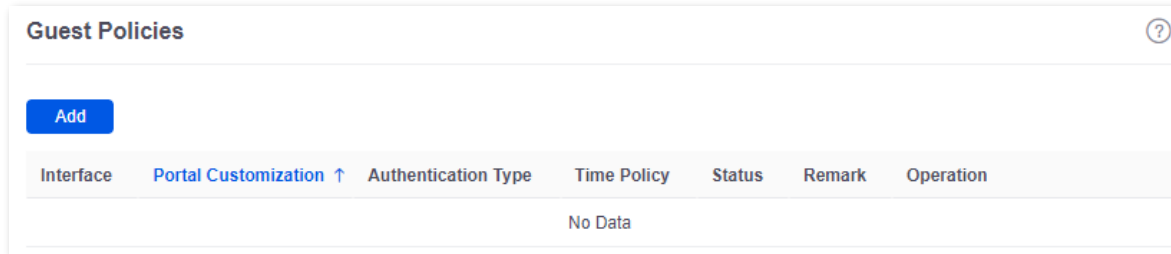

On this page, you can configure the corresponding guest policies based on the VLAN interface.



You can click **Add** to add a new guest policy.

### Parameter description

Parameter	Description
Interface	Specifies the interface that the guest policy is used to. Configure the <a href="#">VLAN interface</a> in advance.
Portal Customization	Specifies the portal customization of the guest policy. The portal customization should be configured in <a href="#">Portal Customization</a> in advance.
Authentication Type	Specifies the authentication type of the guest policy. The authentication type should be configured in <a href="#">Authentication Type</a> in advance.
Time Policy	Specifies the period during which guest policy takes effect. The time policy should be configured in <a href="#">Time Group</a> in advance.

Parameter	Description
Status	Specifies the status of the guest policy, including <b>Enabled</b> , <b>Disabled</b> and <b>Expired</b> .
Remark	Specifies the introduction to the guest policy. The remark is optional.
Operation	Used to edit, disable or delete a guest policy.  <b>Edit</b> : Used to modify the policy.  <b>Enable</b> : Used to enable the policy.  <b>Disable</b> : Used to disable the policy.  <b>Delete</b> : Used to delete the policy.

## 7.6 Account

### 7.6.1 User list

[Log in to the web UI of the router](#), and navigate to **AuthN > Account > User List** to enter the page.

On this page, you can check and export the authentication user information, kick authenticated accounts offline in batches and delete the authentication information of offline users in batches.

You can click  to select parameters to be displayed.

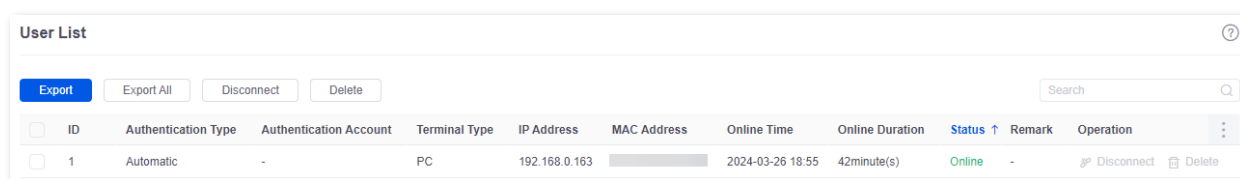



#### Button description

Parameter	Description
Export	Used to back up the configuration information of selected users. The exported file is suffixed with <b>.csv</b> .
Export All	Used to back up the configuration information of all users. The exported file is suffixed with <b>.csv</b> .
Disconnect	Used to disconnect the selected online users who have authenticated successfully. After being disconnected, an online user that has been authenticated before needs to re-authenticate to access the internet and an authentication-free online user will automatically connect to the internet again.
Delete	Used to delete information of selected offline users.

#### Parameter description

Parameter	Description
ID	Specifies the ID of the user.
Authentication Type	Specifies the authentication type of the current authenticated user. The user configured as the authentication-free host is displayed as <b>Authentication-free</b> and the user whose guest policy is not configured is displayed as <b>Automatic</b> .
Authentication Account	Specifies the account, Email, mobile phone number, real name or random code used by the user.

Parameter	Description
Authentication Interface	Specifies the VLAN interface that the guest policy is used.
Terminal Name	Specifies the name of the client.
Terminal Type	Specifies the type of client.
IP Address	Specifies the IP address of the authenticated user.
MAC Address	Specifies the MAC address of the authenticated user.
Online Time	Specifies the first online time of the authenticated user.
Online Duration	Specifies the online duration of the authenticated user.
Status	<p>Specifies the current status of the guest policy.</p> <ul style="list-style-type: none"><li>– <b>Online</b>: Specifies the authentication user is online.</li><li>– <b>Offline</b>: Specifies the authentication user is offline.</li><li>– <b>Authenticating</b>: Specifies the authentication user is authenticating.</li></ul>
Remark	Specifies the introduction to the user.
Operation	<p>Used to disconnect or delete a user.</p> <p> <b>Disconnect</b> : Used to disconnect the user.</p> <p> <b>Delete</b>: Used to delete the user.</p>

## 7.6.2 Account management

### Overview

[Log in to the web UI of the router](#), and navigate to **AuthN > Account > Account** to enter the page.

On this page, you can add a user account for account authentication or PPPoE authentication to access the internet.

You can configure the account charging strategy and upload or download speed to complete the authentication charging and the flow control function. You can also recharge the existing accounts and check the charging records.

You can click  to select parameters to be displayed.

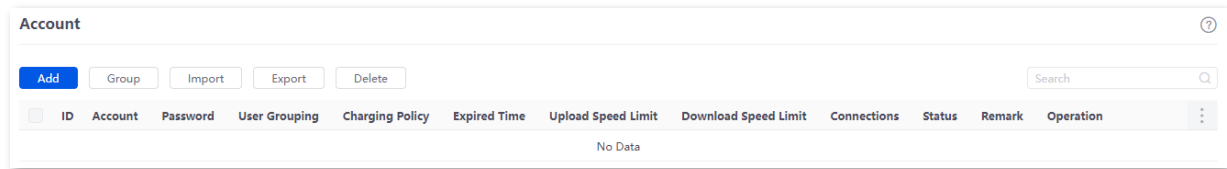











## Button description

Parameter	Description
Add	Used to add an authentication account.
Group	Used to add selected users to <a href="#">user groups</a> .
Import	Used to import the account files backed up previously to the local computer.
Export	Used to back up the information of selected accounts to the local computer. The exported file is suffixed with <b>.csv</b> .
Delete	Used to delete the selected authentication accounts.

## Parameter description

Parameter	Description
ID	Specifies the ID of the authentication account.
Account	Specify the user name and password used for authentication.
Password	
User Grouping	Specifies the <a href="#">user group</a> of the account.
Charging Policy	Specifies the charging policy of the account, which should be configured in <a href="#">Charging Policy</a> in advance. <b>Unused</b> specifies that the charging function is disabled for this account.
Upload Speed Limit/Maximum Upload Speed	Specify the maximum upload and download rate of the account.
	 <b>Tip</b>
Download Speed Limit/Maximum Download Speed	If a charging policy is selected, the maximum upload and download rate configured in the charging policy will be used automatically. If no charging policy is selected, you can manually configure the parameters here.
Account Balance	Specifies the balance of the account. It needs to be entered after the charging policy is selected.

Parameter	Description
Charging Start Time	<p>Specifies the time when the account becomes valid.</p> <p> Note</p> <p>If no charging policy is selected, you can manually configure this parameter.</p>
End Time/Expired Time	<p>Specifies the validity period of internet access of the account. If the internet access period of the account expires after successful authentication, you need to recharge to access the internet again.</p> <p> Note</p> <p>The parameter value will be calculated automatically by the router after the charging policy is selected and the account balance is entered. If no charging policy is selected, the parameter needs to be configured manually.</p>
Connections/Max. Connections	<p>Specifies the maximum number of concurrent connections allowed for the account, which is also the maximum number of conversations that the router can deal with simultaneously.</p> <p>When the account is used by multiple persons at the same time, the number of concurrent connections per person is the set value.</p>
No. of Shared Users	<p>Specifies the number of users that are allowed to use this account to authenticate and access the internet at the same time.</p> <p> Note</p> <p>When the Bind MAC Address function is enabled, the router will bind the first few MAC addresses that successfully use this account to authenticate and access the Internet, and other MAC addresses cannot use this account to authenticate and access the internet. For example, if the number of shared users is 2, the router will bind the first two MAC addresses that successfully use this account to authenticate. Devices with other MAC addresses cannot use this account to authenticate and access the internet.</p>
Bind MAC Address	<p>Specifies whether MAC addresses are bound for authentication. With this function enabled, the router binds the first few MAC addresses that successfully use this account to authenticate and access the internet.</p>
Fixed IP Address	<p>Specifies the fixed IP address of the router. After it is configured, only the device with this IP address can use the account to authenticate and access the internet. By default, the fixed IP address is not configured.</p> <p> Note</p> <p>The fixed IP address does not take effect in the PPPoE authentication type.</p>

Parameter	Description
Status	<p>Specifies the current status of the guest policy.</p> <ul style="list-style-type: none"> <li>- <b>Enabled:</b> Specifies the account has been enabled.</li> <li>- <b>Disabled:</b> Specifies the account has been disabled.</li> <li>- <b>Overdue:</b> Specifies the account balance is insufficient or the account has expired.</li> </ul>
Remark	<p>Specifies the introduction to the authentication account. The remark is optional.</p>
Operation	<p>Used to scan the details of the account, and recharge, edit, disable or delete the account.</p> <ul style="list-style-type: none"> <li> <b>Details</b> : Used to check the account details and operation records.</li> <li> <b>Recharge</b> : Used to recharge the account.</li> <li> <b>Edit</b> : Used to edit the account.</li> <li> <b>Enable</b> : Used to enable the account.</li> <li> <b>Disable</b> : Used to disable the account.</li> <li> <b>Delete</b> : Used to delete the account.</li> </ul>

## Account details and operation records

Click  **Details** of the corresponding account to check the account details and operation records in the pop-up window. The following figure is for reference only.

**View Details** ✕

---

**Account Details**

Account	123	Maximum Upload Bandwidth	No Speed Limit	Account Balance	-
Password	JohnDoe123	Maximum Download Bandwidth	No Speed Limit	Shared Users	1
Charging Policy	-	Start Time	2024-03-01 00:00	Fixed IP Address	-
Max. Connections	600	Expired Time	2025-03-01 00:00	Remark	-

---

**Operation Record**

ID	Operation Type	Operator	Charging Policy	Recharge Amount	Operation Time ↑	Limit Policy
1	Open Account	Administrator	-	-	2024-03-25 08:53	Upload:No Speed Limit, download:No Speed Limit

1 items in total ◀ 1 ▶ 10 ▾

## Recharge the account

Click  **Recharge** of the corresponding account to recharge the account in the pop-up window or change the charging policy.



If no charging policy is used in the account, you can change the expired time manually to recharge the account.

**Account Recharge**
✕



Account	123	
Current Package	-	
Package Validity Period	2024-03-01 00:00 ~ 2025-03-01 00:00	
Account Status	Normal	
Recharge Operation	Account Recharge <span>▼</span>	
Select Charging Policy	Unused <span>▼</span>	
Account Balance	<input type="text"/>	dollars
Maximum Upload Speed	<input type="text" value="0"/>	KB/s ⓘ
Maximum Download Speed	<input type="text" value="0"/>	KB/s ⓘ
Charging Start Time	<input type="text" value="2024-03-01 00:00"/> ⓘ	
End Time	<input type="text" value="2025-03-01 00:00"/> ⓘ	
Remark	<input type="text"/> (Optional)	

Cancel
Save

### Parameter description

Parameter	Description
Account	Specifies the account used for authentication.
Current Package	Specifies the name of the account charging policy.
Package Validity Period	Specifies the start time and end time the account takes effect.
Account Status	Specifies the current status of the account.
Recharge Operation	<p>Used to select the recharge operation. You can select <b>Account Recharge</b> to renew the current package or <b>Charging Policy Modification</b> to change the current package.</p> <div style="display: flex; align-items: center; gap: 5px;"> <span style="color: #007bff; font-size: 1.2em;">✍</span> <span style="font-size: 0.8em;">Note</span> </div> <p>Changing the charging policy will clear the account balance and validity period.</p>
Select Charging Policy	Used to select the charging policy of the account. When <b>Recharge Operation</b> is set to <b>Charging Policy Modification</b> , you can select a new charging policy here.



Parameter	Description
Account Balance	<p>Specifies the balance of the charging.</p> <p> Tip</p> <p>If no charging policy is used on the account, which means that <b>Select Charging Policy</b> is set to <b>Unused</b>, account balance cannot be set.</p>
Maximum Upload Speed	<p>Specify the maximum upload and download speed of the current account.</p> <p> Tip</p>
Maximum Download Speed	<p>If no charging policy is used on the account, which means that <b>Recharge Operation</b> is set to <b>Charging Policy Modification</b> and <b>Select Charging Policy</b> is set to <b>Unused</b>, these parameters need to be set manually.</p>
Charging Start Time	<p>Specifies the time when the account starts to take effect.</p>
End Time	<p>Specifies the validity end time for using the account to access the internet. After this account is authenticated and connected to the internet successfully, if the online time exceeds the end time, you need to recharge to access the internet.</p> <p> Tip</p> <p>If no charging policy is used on the account, which means that <b>Select Charging Policy</b> is set to <b>Unused</b>, the parameter needs to be set manually.</p>
Remark	<p>Specifies the introduction to the recharge policy. The remark is optional.</p>

### 7.6.3 Charging policy

[Log in to the web UI of the router](#), and navigate to **AuthN > Account > Charging Policy** to enter the page.

On this page, you can configure charging policies based on actual charging requirements.

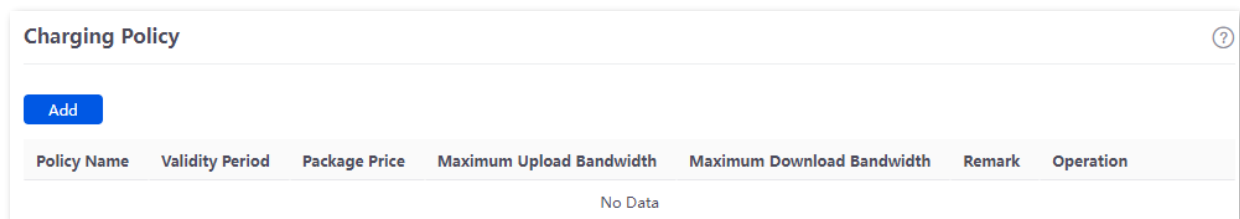

You can click **Add** to add a new charging policy.

### Parameter description

Parameter	Description
Policy Name	Specifies the name of the charging policy.
Validity Period	Specifies the charging cycle of a charging policy.
Package Price	Specifies the package amount of a charging cycle. For example, if the charging cycle is 1 hour, and the package price is \$2, then it costs \$2 per hour to access the internet using this charging policy.
Maximum Upload Bandwidth	Specify the maximum upload and download rate of the account. <b>0</b> indicates no limit.
Maximum Download Bandwidth	
Remark	Specifies the introduction to the charging policy. The remark is optional.
Operation	Used to edit or delete the charging policy. <b>Edit</b> : Used to modify the policy. <b>Delete</b> : Used to delete the policy.

## 7.6.4 Authentication-free policy

[Log in to the web UI of the router](#), and navigate to **AuthN > Account > Authentication-free Policy** to enter the page.

On this page, you can configure the authentication-free policies for special devices such as network cameras. After configuration, these devices can connect to the internet without authentication.

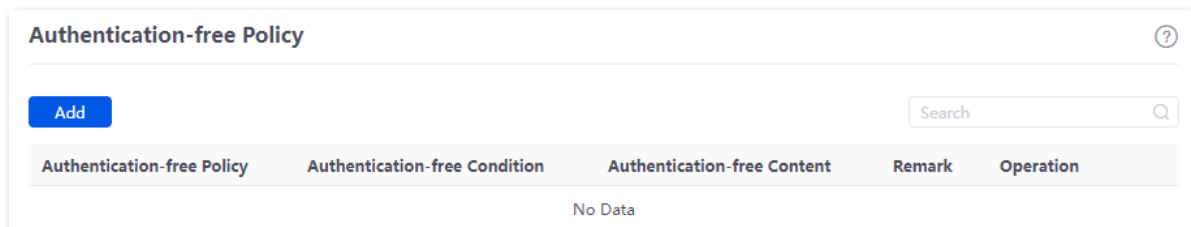

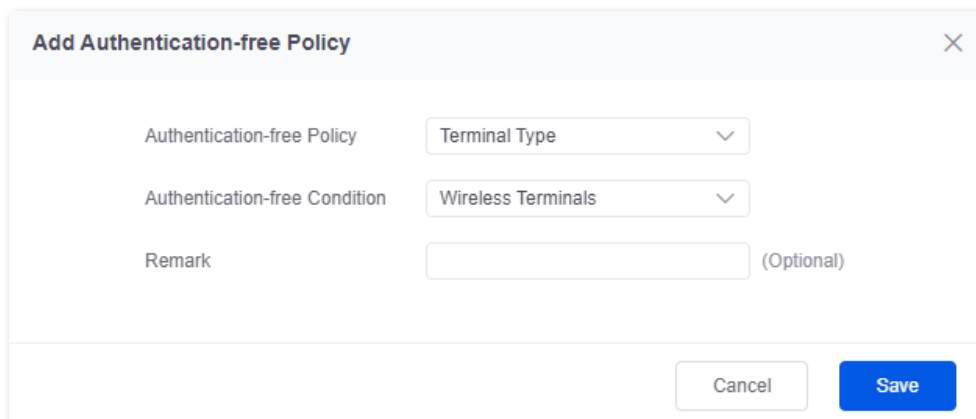

You can click **Add** to add a new authentication-free policy.



### Parameter description

Parameter	Description
Authentication-free Policy	Specifies the authentication-free policy type of the router, including <b>Terminal Type</b> and <b>Terminal Unique Information</b> .

Parameter	Description
Authentication-free Condition	<p>Specifies the condition of the authentication-free policy. Only the clients that meet the condition can access the internet without authentication.</p> <p>When <b>Authentication-free Policy</b> is set to <b>Terminal Unique Information</b>, the following authentication-free conditions are available:</p> <ul style="list-style-type: none"> <li>– <b>Mobile Number:</b> When SMS authentication is enabled, set mobile numbers that do not require authentication to enable them to access the internet without obtaining verification codes.</li> <li>– <b>IP Address:</b> Devices with the configured IP addresses can access the internet without authentication.</li> <li>– <b>MAC Address:</b> Devices with the configured MAC addresses can access the internet without authentication.</li> </ul> <p>When <b>Authentication-free Policy</b> is set to <b>Terminal Type</b>, the following authentication-free conditions are available:</p> <ul style="list-style-type: none"> <li>– <b>Wired Terminals:</b> Devices that are connected to the LAN of the router in a wired manner can access the internet without authentication.</li> <li>– <b>Wireless Terminals:</b> Devices that are connected to the LAN of the router in a wireless manner can access the internet without authentication.</li> <li>– <b>Mobile Phone:</b> Devices that are identified as mobile phones can access the internet without authentication.</li> </ul>
Authentication-free Content	<p>Specifies the content of the authentication-free policy. When a device meets both the authentication-free policy and content, it can access the internet without authentication. “–” indicates no authentication contents.</p>
Remark	<p>Specifies the introduction to the authentication-free policy. The remark is optional.</p>
Operation	<p>Used to edit or delete an authentication-free policy.</p> <p> <b>Edit</b> : Used to modify the policy.</p> <p> <b>Delete</b> : Used to delete the policy.</p>

## 7.6.5 Random code account

[Log in to the web UI of the router](#), and navigate to **AuthN > Account > Random Code Account** to enter the page.

On this page, you can add the random codes used in random code authentication.

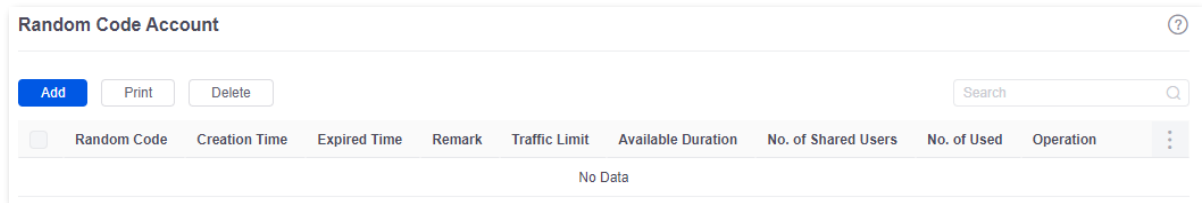

You can click **Add** to add a new random code account policy.

**Add Random Code Account** ✕

No. of Created Codes

Account Validity Period  hr(s) ⓘ

Account Usage Duration  minute(s) ⓘ

Traffic Limit  MB ⓘ

No. of Shared Users  ⓘ

Random Code Title  ⓘ



Remark  (Optional)

### Button description

Button	Description
Add	Used to add a random code.
Print	Used to print some information of the selected random codes with the printer installed on your computer.
Delete	Used to delete the selected authentication-free policies.

### Parameter description

Parameter	Description
Random Code	Specifies the random code used for authentication.

Parameter	Description
Creation Time	Specifies the time when the random code is created.
No. of Created Codes	Specifies the number of random codes to be created.
Account Validity Period	Specifies the validity period of the random code, ranging from 0 to 87600. <b>0</b> indicates no limit.
Expired Time	Specifies the time point when the random code expires. Expired accounts cannot be used again. The expiration time point is calculated based on the creation time of the random code and the validity period of the configured account.
Remark	Specifies the introduction to the random code. The remark is optional.
Traffic Limit	Specifies the total download traffic that the random code is allowed to use. Once this value is exceeded, the random code will be denied internet access.
Available Duration	Specifies the longest duration this random code is allowed to stay online at a time. When the random code expires, the user needs to log in again.
No. of Shared Users	<p>Specifies the number of users who are allowed to access the internet using this random code at the same time.</p> <p> <b>Note</b></p> <p>The Bind MAC Address function is enabled by default in Random Code guest policies. For example, if the number of shared users is 2, the router will bind the first two MAC addresses that successfully use this random code to authenticate. Devices with other MAC addresses cannot use this random code to authenticate and access the internet.</p>
No. of Used	Specifies the number of users who are using the random code to access the internet.
Random Code Title	Specifies the title of the random code. It appears on the central upper part of the page. You can use it for advertising promotion. For example, "Welcome to XX".
Operation	<p>Used to print or delete a random code.</p> <p> <b>Print</b> : Used to print the random code.</p> <p> <b>Delete</b> : Used to delete the random code.</p>

## 7.7 Example of authentication for rented flats

### 7.7.1 Networking requirements

An owner of rented flats uses a router as the egress gateway. Tenants need to pay by month to get internet access when connecting to the flat network.

To manage the network usage, the following requirements are raised for the flat network:

- All tenants have to access the internet using the PPPoE connection mode.
- Two internet access packages (\$15 per month with 20 MHz bandwidth and \$50 per month with 100 MHz bandwidth) are provided for tenants.
- The flat manager's computer can access the internet without authentication for convenient management.

The following figure shows the network topology.

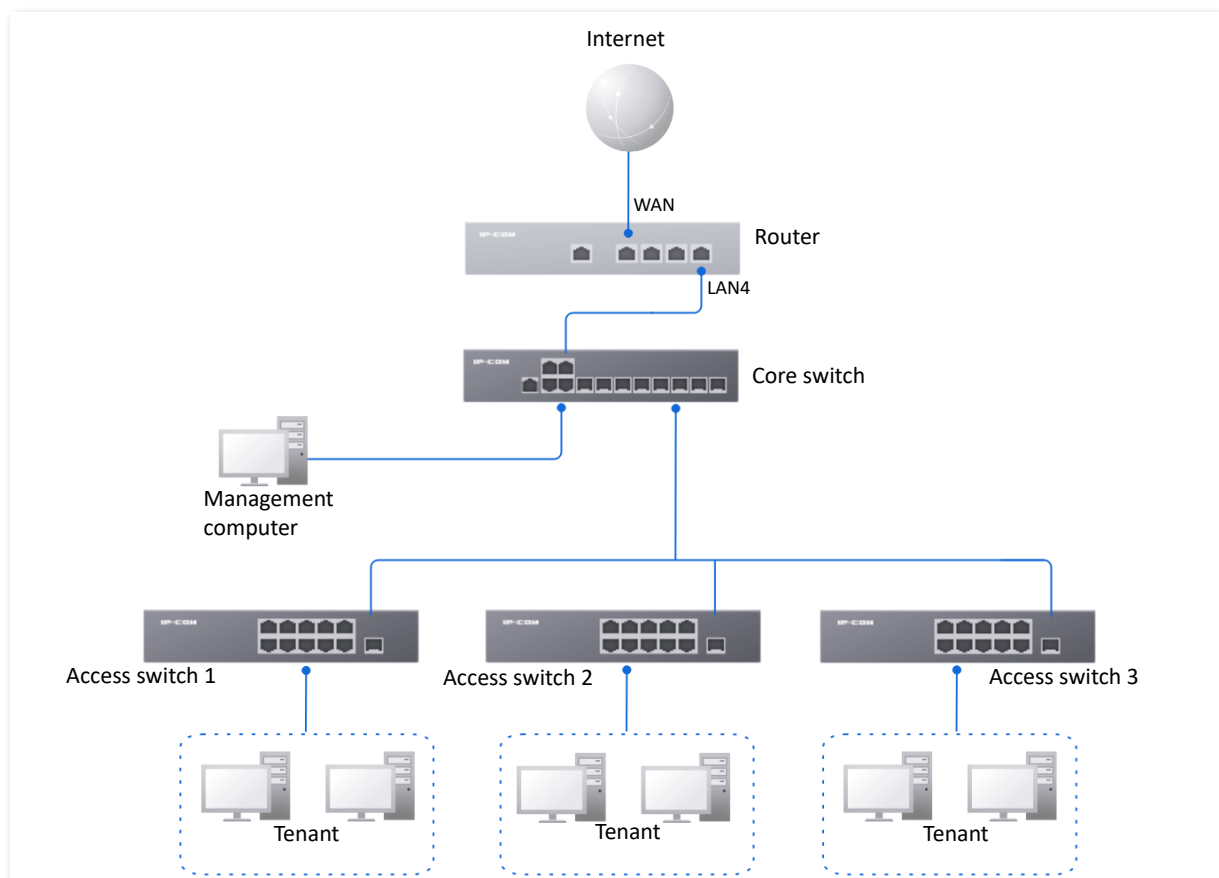

### 7.7.2 Solution

- Configure the PPPoE authentication based on the VLAN interface.
- Configure an authentication-free policy for the manager's computer.
- Configure authentication accounts.

## 7.7.3 Configuration procedure

Configure the router

Configure the core switch

### I. Configure the router.

1. [Log in to the web UI of the router.](#)
2. Add VLANs and configure a DHCP server.

The following table lists the VLAN parameters for example.

VLAN Name	VLAN ID	IP Address/Network Segment	Physical Port
Tenant	20	192.168.20.1/24	LAN4

The following table lists the DHCP server parameters of the VLAN for example.

Policy Name	Interface	User DHCP	AP DHCP
Tenant	<a href="#">Tenant</a>	IP address pool: 192.168.20.100 - 192.168.20.200 Subnet mask: 255.255.255.0 Default gateway: 192.168.20.1 Primary DNS: 192.168.20.1	/

#### 1) Add VLANs.

Navigate to **Network > VLAN Settings**. Click **Add**, configure VLAN parameters and click **Save**.

VLAN Name	VLAN ID	IP Address	Subnet Mask	Interface	Remark	Allow Access	Status	Operation
VLAN_Default	1	192.168.0.252	255.255.255.0	LAN1,LAN2,LAN3,LAN4	-	Allow	Enabled	<a href="#">Edit</a> <a href="#">Disable</a> <a href="#">Delete</a>
Tenant	20	192.168.20.1	255.255.255.0	LAN4	-	Allow	Enabled	<a href="#">Edit</a> <a href="#">Disable</a> <a href="#">Delete</a>

#### 2) Configure the DHCP server for the VLAN.

Navigate to **Network > DHCP Settings > DHCP Server**. Click **Add**, configure parameters for user DHCP server of the Tenant VLAN and click **Save**.

Policy Name	DHCP Type	Interface	Client Address	Subnet Mask	Gateway	Primary DNS	Lease	Status	Remark	Operation
User_DHCP_Default	User DHCP	VLAN_Default	192.168.0.2-192.168.0.254	255.255.255.0	192.168.0.252	192.168.0.252	30min	Enabled	-	<a href="#">Edit</a> <a href="#">Disable</a> <a href="#">Delete</a>
AP_DHCP_Default	AP DHCP	VLAN_Default	10.10.96.2-10.10.96.254	255.255.255.0	10.10.96.1	10.10.96.1	30min	Enabled	-	<a href="#">Edit</a> <a href="#">Disable</a> <a href="#">Delete</a>
Tenant	User DHCP	Tenant	192.168.20.100-192.168.20.200	255.255.255.0	192.168.20.1	192.168.20.1	30min	Enabled	-	<a href="#">Edit</a> <a href="#">Disable</a> <a href="#">Delete</a>



### 3. Configure the PPPoE authentication type.

The following table lists the PPPoE authentication parameters for example.

Authentication Mode and Related Parameters	Guest Policies
Policy Name: Tenant PPPoE Authentication	
Authentication Type: PPPoE	
LCP Detection Interval: 10s	Interface: <a href="#">Tenant</a>
LCP Detection Failure Attempts: 10	Portal Customization: Do Not Select
PPPoE Server Name: PPPoE_1	Authentication Type: <a href="#">Tenant PPPoE Authentication</a>
PPPoE Server IP: 192.168.30.1	Time Policy: Do Not Select
Client IP Address Range: 192.168.30.100 - 192.168.30.200	
Primary DNS: 192.168.30.1	

#### 1) Add the PPPoE authentication type.

Navigate to **AuthN > Authentication Template > Authentication Type**, and click **Add**. Configure parameters as required, and click **Save**. The following figure is for reference only.

#### 2) Add guest policies for tenants.

Navigate to **AuthN > Guest Policies**, and click **Add**. Configure parameters as required, and click **Save**. The following figure is for reference only.

4. Configure the PPPoE service package.

The following table lists the PPPoE package parameters for example.

20 MHz Package	100 MHz Package
Policy Name: 20 MHz	Policy Name: 100 MHz
Validity Period: 30 days	Validity Period: 30 days
Package Price: 15 dollars	Package Price: 50 dollars
Maximum Upload Bandwidth: 5120 KB/s	Maximum Upload Bandwidth: 10240 KB/s
Maximum Download Bandwidth: 20480 KB/s	Maximum Download Bandwidth: 102400 KB/s

Navigate to **AuthN > Account > Charging Policy**, and click **Add**. Configure parameters as required, and click **Save**. The following figure is for reference only.

Policy Name	Validity Period	Package Price	Maximum Upload Bandwidth	Maximum Download Bandwidth	Remark	Operation
20 MHz	30day(s)	\$15	5120KB/s	20480KB/s	-	<a href="#">Edit</a> <a href="#">Delete</a>
100 MHz	30day(s)	\$50	10240KB/s	102400KB/s	-	<a href="#">Edit</a> <a href="#">Delete</a>

5. Configure authentication accounts for tenants.

The following table lists the account parameters for example. For other parameters not mentioned, the default settings are used.

User Group	Authentication Account
Group Name: Tenant PPPoE Authentication	Account: Room number Password: Room number+Mobile number User Grouping: Tenant PPPoE Authentication
User Group Type: Authentication User Group	Select Charging Policy: 20 MHz or 100 MHz Account Balance: Set as required No. of Shared Users: 1

1) Add the user group.

Navigate to **Audit > Group Policy > User Group**, and click **Add**. Configure parameters as required, and click **Save**. The following figure is for reference only.

The screenshot shows a dialog box titled "Add User Group" with a close button (X) in the top right corner. The dialog contains the following fields:

- Group Name:** A text input field containing "Tenant PPPoE Authentication".
- User Group Type:** A dropdown menu with "Authentication User Group" selected.
- Remark:** An empty text input field with "(Optional)" text to its right.

At the bottom right of the dialog, there are two buttons: "Cancel" and "Save".

2) Add an authentication account and add it to the user group.

Navigate to **AuthN > Account > Account**, and click **Add**. Configure parameters as required, and click **Save**. The following figure is for reference only.

**Add Account**

Account: 101

Password: .....

User Grouping: Tenant PPPoE Authentication

Select Charging Policy: 20 MHz

Maximum Upload Speed: 5120 KB/s

Maximum Download Speed: 20480 KB/s

Account Balance: 100 dollars

Charging Start Time: 2024-03-26 20:25

End Time: 2024-10-12 20:25

Max. Connections: 600

Bind MAC Address:  Enable  Disable

No. of Shared Users: 1

Fixed IP Address: . . .

Buttons: Cancel, Save

3) Repeat the substep [2](#)) to configure authentication accounts for other tenants.

6. Configure the authentication-free policy.

Assume that the MAC address of the computer to which the authentication-free policy applies is 44:37:E6:12:34:56.

Navigate to **AuthN > Account > Authentication-free Policy**, and click **Add**. Configure parameters as required, and click **Save**.

**Add Authentication-free Policy**

Authentication-free Policy: Terminal Unique Information

Authentication-free Condition: MAC Address

Authentication-free Content: 44:37:E6:12:34:56  
Use semicolons (;) to separate multiple MAC addresses.

Remark: (Optional)

Buttons: Cancel, Save

## II. Configure the core switch.

Divide the IEEE 802.1Q VLAN on the VLAN as follows.

Port Connected to	VLAN ID (VLAN Allowed to Pass)	Port Property	PVID
Router	20	Trunk	20
Access switch	20	Access	20

For other ports that are not mentioned, keep the default settings. For details about the configuration procedure, see the user guide of the corresponding switch.

---End

### 7.7.4 Verification

The flat manager's computer (MAC address: 44:37:E6:12:34:56) can access the internet without authentication.

Tenants need to dial in when accessing the internet.

#### Dial-up from the router

This method is applicable for scenarios where the tenant uses a router to connect to the broadband Ethernet port of the flat network. For details about the router settings, see the user guide of the corresponding router.

1. Log in to the web UI of the router of the tenant.
2. Set the internet connection type to PPPoE, enter the PPPoE user name and password, and save the settings.

After the settings, the tenant can access the internet through the router.

## Dial-up from the computer

It is suitable for scenarios where the tenant uses the computer to connect to the broadband Ethernet port of the flat network. Windows 10 is used for example in the following steps.

1. Right-click  in the lower-right corner of your desktop. Then click **Network & Internet**.
2. Click **Dial-up** in the left navigation bar. Then, click **Set up a new connection**.

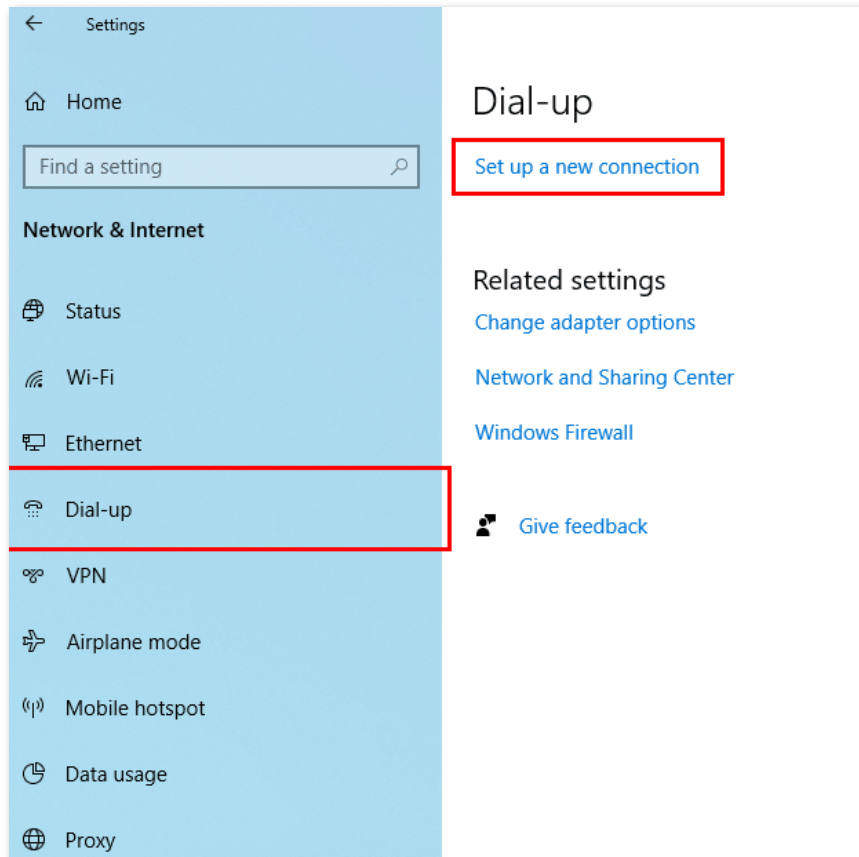

3. Select **Connect to the Internet**, and click **Next**.

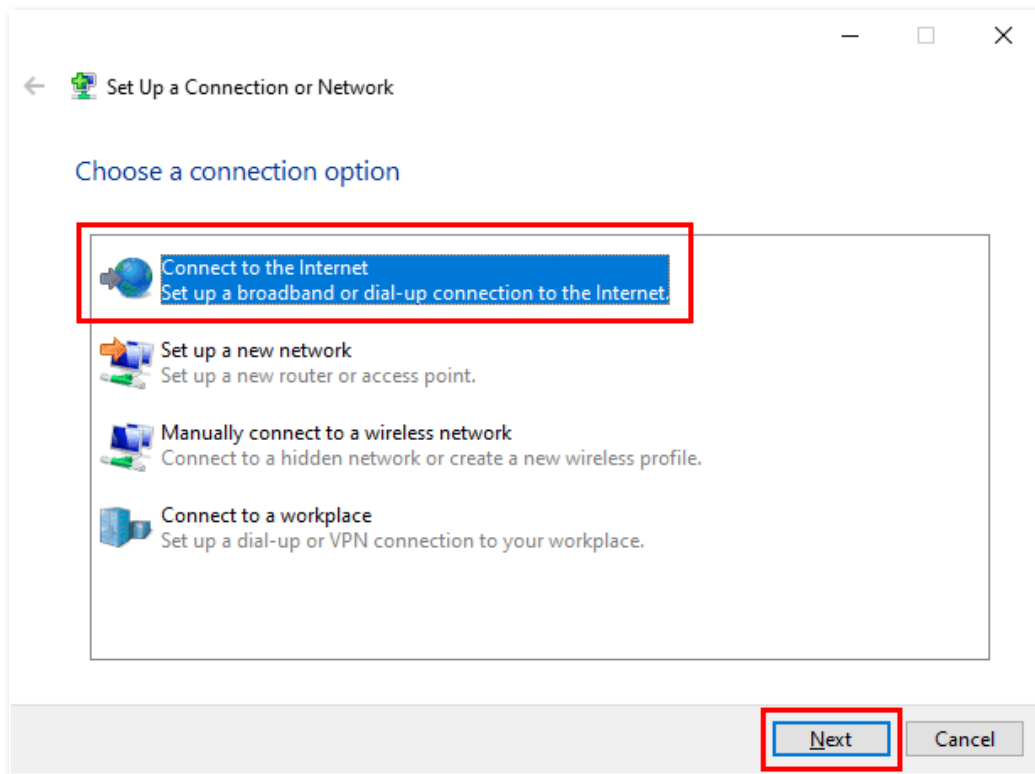

4. Select **Broadband (PPPoE)**.

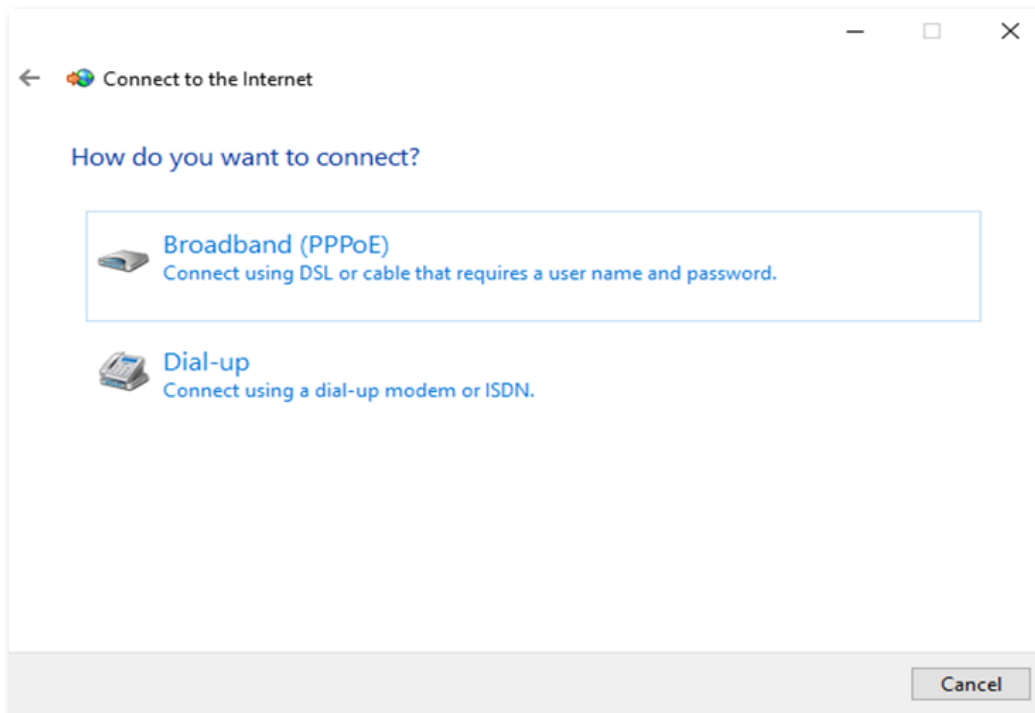

5. Enter the PPPoE user name and password, select **Remember this password**, and click **Connect**.

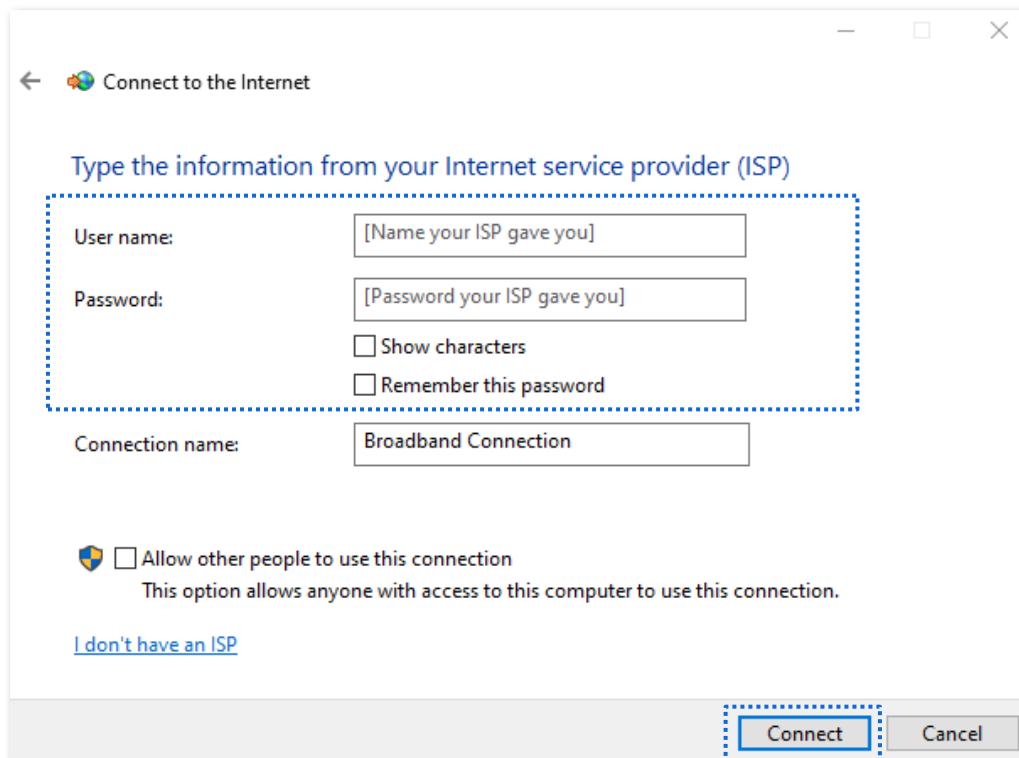

Wait until the dial-up completes successfully. Then the tenant can access the internet.

To access the internet after the tenant's computer is restarted, click  and then **Broadband Connection** to perform dial-up again.



# 8 Bandwidth limit

## 8.1 WAN bandwidth

[Log in to the web UI of the router](#), and navigate to **BW Limit > WAN Bandwidth** to enter the page.

On this page, you can configure the WAN port bandwidth parameters. After you set [multiple WAN ports](#), you can limit the bandwidth of multiple WAN ports respectively.

By properly configuring the WAN port bandwidth, you can allocate bandwidth to LAN users more accurately when using the [Group Speed Limit](#) policy.

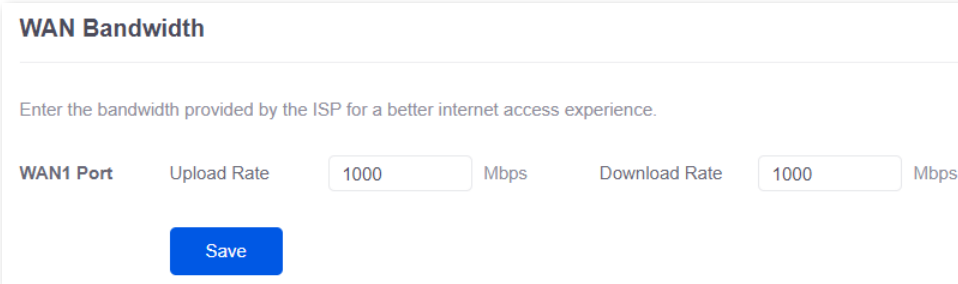

**WAN Bandwidth**

Enter the bandwidth provided by the ISP for a better internet access experience.

WAN1 Port    Upload Rate    1000    Mbps    Download Rate    1000    Mbps

Save

### Parameter description

Parameter	Description
Upload Rate	Specify the bandwidth values of the broadband. If you are not sure, contact your ISP for help.
Download Rate	

## 8.2 Group limit

The extranet bandwidth is always limited, so the network administrator needs to control users' network speed to reasonably allocate the limited bandwidth resources, utilizing the extranet resources effectively.

[Log in to the web UI of the router](#), and navigate to **BW Limit** > **Group Limit** to enter the page.

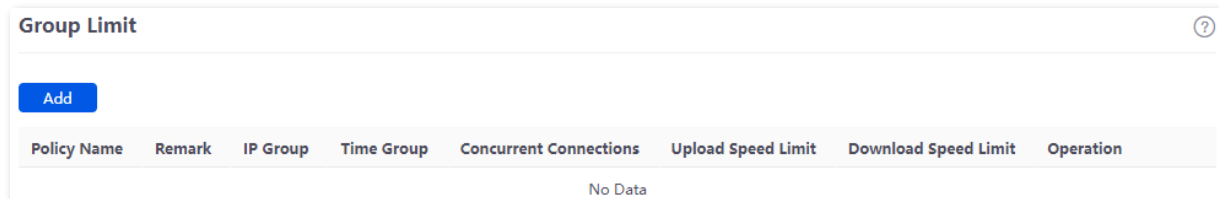

On this page, you can configure the group speed limit policy of the router.



You can click **Add** to add a new group limit policy.

### Parameter description

Parameter	Description
Policy Name	Specifies the name of the group limit policy.
Remark	Specifies the remark of the group limit policy. The remark is optional.

Parameter	Description
IP Group	<p>Specifies the IP address group upon which the group speed limit policy takes effect. The group speed limit policy takes effect only when the device IP addresses are in the IP address group.</p> <p>Configure the IP group in <a href="#">IP Group</a> first.</p>
Time Group	<p>Specifies the time group upon which the group speed limit policy takes effect. The group speed limit policy takes effect only in such configured time.</p> <p>Configure the time group in <a href="#">Time Group</a> first.</p>
Concurrent Connections	<p>Specifies the maximum connections for a single use device in the controlled IP group.</p> <p> Tip</p> <p>0 indicates no limit.</p>
Upload Speed Limit	<p>Specify the maximum upload or download rate of the controlled user.</p> <p> Tip</p>
Download Speed Limit	<p>0 indicates no limit.</p>

## 8.3 Single user limit

### 8.3.1 Overview

[Log in to the web UI of the router](#), and navigate to **BW Limit** > **Single User Limit** to enter the page.

On this page, you can configure the maximum upload or download rates for users connected to the router separately or in a unified way according to the actual requirements.

You can click  to select parameters to be displayed.

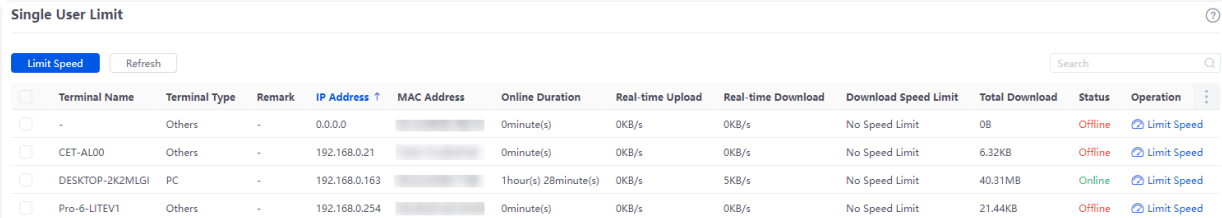

Terminal Name	Terminal Type	Remark	IP Address	MAC Address	Online Duration	Real-time Upload	Real-time Download	Download Speed Limit	Total Download	Status	Operation
-	Others	-	0.0.0.0		0minute(s)	0KB/s	0KB/s	No Speed Limit	0B	Offline	<a href="#">Limit Speed</a>
CET-AL00	Others	-	192.168.0.21		0minute(s)	0KB/s	0KB/s	No Speed Limit	6.32KB	Offline	<a href="#">Limit Speed</a>
DESKTOP-2K2MLGI	PC	-	192.168.0.163		1hour(s) 28minute(s)	0KB/s	5KB/s	No Speed Limit	40.31MB	Online	<a href="#">Limit Speed</a>
Pro-6-LITEV1	Others	-	192.168.0.254		0minute(s)	0KB/s	0KB/s	No Speed Limit	21.44KB	Offline	<a href="#">Limit Speed</a>

## Parameter description

Parameter	Description
Terminal Name	Specifies the name of the client device.
Terminal Type	Specifies the type of the client device.
Remark	Specifies the remark of the client device.
IP Address	Specifies the IP address of the client device.
MAC Address	Specifies the MAC address of the client device.
Online Duration	Specifies the online duration of the client device.
Real-time Upload	Specify the real-time upload or download rate of the client device.
Real-time Download	
Upload Speed Limit	Specifies the maximum upload rate of the client device.
Total Upload	Specifies the total upload traffic of the client device.
Download Speed Limit	Specifies the maximum download rate of the client device.
Total Download	Specifies the total download traffic of the client device.
Status	Specifies the status of the device, including <b>Online</b> and <b>Offline</b> .
Limit Speed	Used to limit the speed of the selected devices.
Refresh	Used to refresh the current list.

## 8.3.2 Configure single user limit

1. [Log in to the web UI of the router](#), and navigate to **BW Limit > Single User Limit**.
2. Select the client device to be limited and click **Limit Speed**. The following figure is for reference only.



You can select multiple client devices and click **Limit Speed** to set speed limits for the devices at a time.

<input type="checkbox"/>	Terminal Name	Terminal Type	Remark	IP Address ↑	MAC Address	Online Duration	Real-time Upload	Real-time Download	Download Speed Limit	Total Download	Status	Operation
<input type="checkbox"/>	-	Others	-	0.0.0.0		0minute(s)	0KB/s	0KB/s	No Speed Limit	0B	Offline	<a href="#">Limit Speed</a>
<input type="checkbox"/>	CET-AL00	Others	-	192.168.0.21		0minute(s)	0KB/s	0KB/s	No Speed Limit	6.32KB	Offline	<a href="#">Limit Speed</a>
<input type="checkbox"/>	DESKTOP-2K2MLGI	PC	-	192.168.0.163		1hour(s) 28minute(s)	0KB/s	5KB/s	No Speed Limit	40.31MB	Online	<a href="#">Limit Speed</a>
<input type="checkbox"/>	Pro-6-LITEV1	Others	-	192.168.0.254		0minute(s)	0KB/s	0KB/s	No Speed Limit	21.44KB	Offline	<a href="#">Limit Speed</a>

3. Set the **Upload Speed Limit** and **Download Speed Limit** for the selected client device, and click **Save**. The following figure is for reference only.



0 indicates no limit.

Speed Limit

Upload Speed Limit  KB/s ⓘ

Download Speed Limit  KB/s ⓘ

Cancel Save

----End

## 8.4 Example of configuring group speed limit

### Networking requirements

An enterprise uses the enterprise router to deploy a network.

Requirements: Each purchasing staff (IP address range: 192.168.0.2 – 192.168.0.50) in the LAN can use the fixed upload and download bandwidth of 1 Mbps (1 Mbps = 128 KB/s) during working hours (8:00 - 18:00) from Monday to Friday while other devices in the LAN are not restricted for bandwidth.

### Solution

The Group Limit function of the router can achieve the requirements. Assume that the concurrent connections of each user device are 600.

### Configuration procedure

Configure the time group

Configure the IP group

Add the group limit policy

1. [Log in to the web UI of the router.](#)
2. Configure the time group.

Navigate to **Audit > Group Policy > Time Group**, and click **Add** to configure the following time group.

**Edit Time Group** [X]

Policy Name: Business Hours

Time Period 1: 08:00 → 18:00 [v]

Time Period 2: Start Time → End Time [v] (Optional)

Time Period 3: Start Time → End Time [v] (Optional)

Cycle: [v] Every Day

Mon.  Tues.  Wed.  Thur.  
 Fri.  Sat.  Sun.

Remark: [ ] (Optional)

[Cancel] [Save]

### 3. Configure the IP group.

Navigate to **Audit > Group Policy > IP Group**, and click **Add** to configure the following IP group.

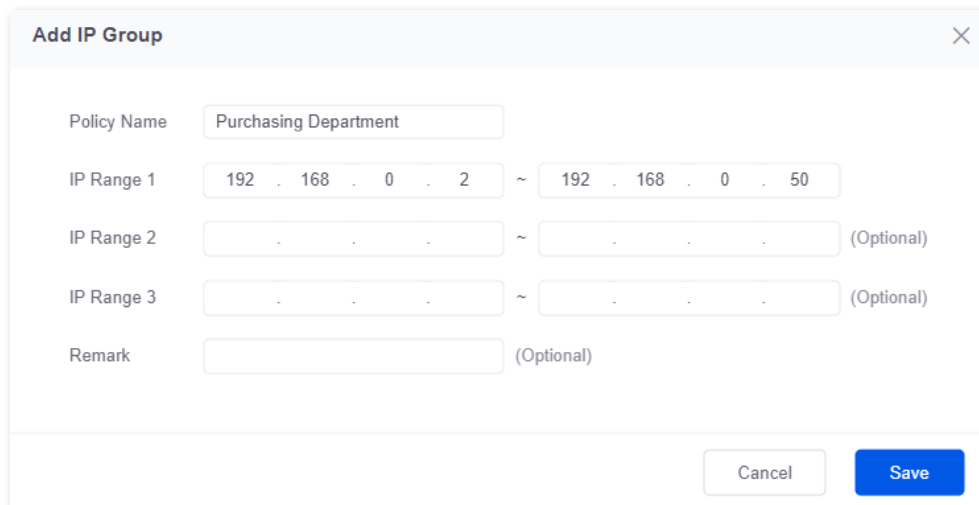

### 4. Add the group limit policy.

1) Navigate to **BW Limit > Group Limit**, and click **Add**.

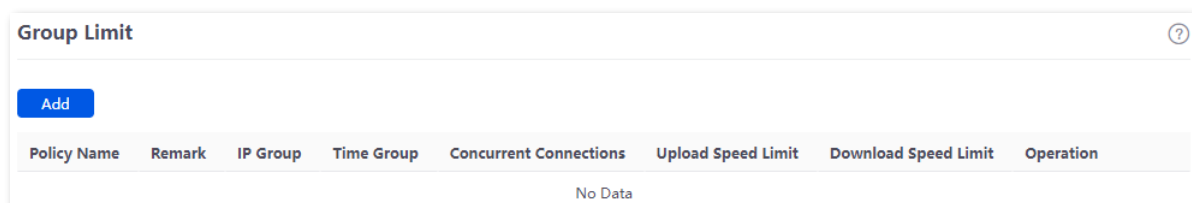

2) Configure the parameters in the **Add Group Limit Policy** window, and click **Save**.

- Set the **Policy Name**, which is **Speed Limit** in this example.
- Select the **IP Group** to which the policy applies, which is **Purchasing Department** in this example.
- Select the **Time Group** to which the policy applies, which is **Business Hours** in this example.
- Set the **Concurrent Connections** per client, which is **600** in this example.
- Set the **Upload Speed Limit** and **Download Speed Limit** of client devices, which are both **128 KB/s**.

The screenshot shows a dialog box titled "Add Group Limit Policy" with a close button (X) in the top right corner. The dialog contains the following fields and values:

Policy Name	Speed Limit
Remark	(Optional)
IP Group	Purchasing Department
Time Group	Business Hours
Concurrent Connections	600
Upload Speed Limit	128 KB/s
Download Speed Limit	128 KB/s

At the bottom right of the dialog, there are two buttons: "Cancel" and "Save".

----End

## Verification

For users with IP addresses ranging from 192.168.0.2 - 192.168.0.50, the maximum upload speed and download speed are both 128 KB/s at 8:00 - 18:00 from Monday to Friday.



# 9 Behavior&Audit

## 9.1 Group policy

When configuring the functions such as various kinds of filtering, group limit and multi-WAN policy, you need to configure the IP group, and time group in advance.

### 9.1.1 Time group

The time group policy is used to divide time into different groups and combine different groups randomly.

[Log in to the web UI of the router](#), and navigate to **Audit > Group Policy > Time Group** to enter the page.

On this page, you can configure the time group policy according to the actual requirements.

#### Configuration procedure:

1. [Log in to the web UI of the router](#).
2. Navigate to **Audit > Group Policy > Time Group**.
3. Click **Add**.

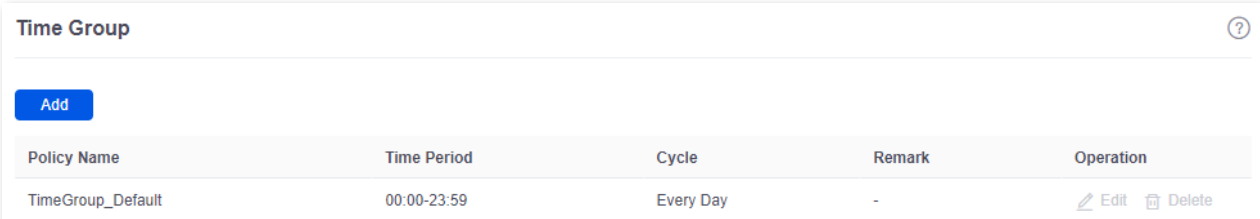

Policy Name	Time Period	Cycle	Remark	Operation
TimeGroup_Default	00:00-23:59	Every Day	-	<a href="#">Edit</a> <a href="#">Delete</a>

4. Configure the parameters in the **Add Time Group** window, and click **Save**.

The screenshot shows a dialog box titled "Add Time Group" with a close button (X) in the top right corner. The dialog contains the following fields and options:

- Policy Name:** A text input field.
- Time Period 1:** A field with "Start Time" and "End Time" labels, a right-pointing arrow, and a clock icon.
- Time Period 2:** A field with "Start Time" and "End Time" labels, a right-pointing arrow, a clock icon, and the text "(Optional)".
- Time Period 3:** A field with "Start Time" and "End Time" labels, a right-pointing arrow, a clock icon, and the text "(Optional)".
- Cycle:** A group of radio buttons with the following options: "Every Day", "Mon.", "Tues.", "Wed.", "Thur.", "Fri.", "Sat.", and "Sun.".
- Remark:** A text input field with the text "(Optional)" to its right.

At the bottom right of the dialog, there are two buttons: "Cancel" and "Save".

----End

### Parameter description

Parameter	Description
Policy Name	Specifies the name of the time group policy.
Time Period	Specifies the periods included in the time group. One policy supports at most 3 periods, and the periods cannot be repeated.
Cycle	Specifies the cycle upon which the time group policy takes effect.
Remark	Specifies the remark of the time group policy. The remark is optional.

## 9.1.2 IP group

The IP group policy is used to set the hosts within the LAN into different groups based on their IP addresses.

[Log in to the web UI of the router](#), and navigate to **Audit > Group Policy > IP Group** to enter the page.

On this page, you can configure the IP group policy according to the actual requirements.

### Configuration procedure:

1. [Log in to the web UI of the router](#).
2. Navigate to **Audit > Group Policy > IP Group**.
3. Click **Add**.

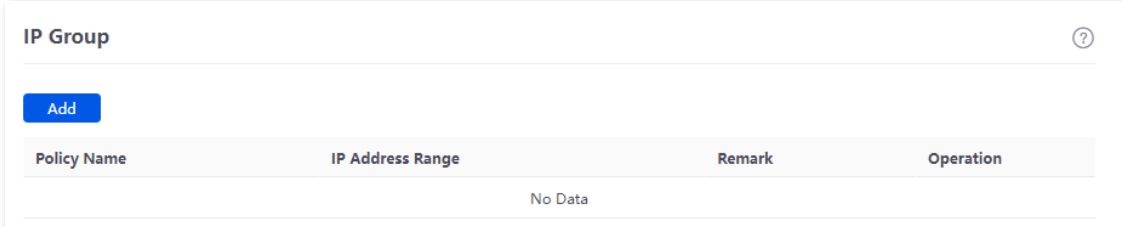

Policy Name	IP Address Range	Remark	Operation
No Data			

4. Configure the parameters in the **Add IP Group** window, and click **Save**.

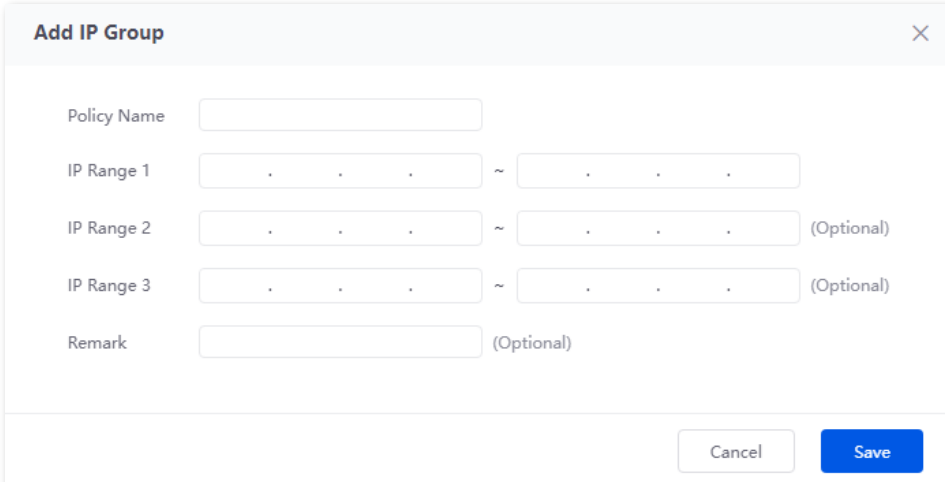

**Add IP Group** [X]

Policy Name

IP Range 1    ~

IP Range 2    ~    (Optional)

IP Range 3    ~    (Optional)

Remark  (Optional)

----End

### Parameter description

Parameter	Description
Policy Name	Specifies the name of the IP group policy.

Parameter	Description
IP Address Range	Specifies the IP address ranges included in the IP group. One policy supports at most 3 IP address ranges, and the IP address ranges cannot be repeated.
Remark	Specifies the remark of the IP group policy.

### 9.1.3 User group

The user group policy is used to set the hosts within the LAN into different groups based on authenticated users and VPN dial-up users.

[Log in to the web UI of the router](#), and navigate to **Audit > Group Policy > User Group** to enter the page.

On this page, you can configure the user group policy according to the actual requirements.



Two user groups named **User\_Default** and **VPNUser\_Default** have been added by default. The default user group cannot be deleted or edited.

#### Configuration procedure:

1. [Log in to the web UI of the router](#).
2. Navigate to **Audit > Group Policy > User Group**.
3. Click **Add**.

Group Name	User Group Type	Remark	Operation
User_Default	Authentication User Group	-	Edit  Delete
VPNUser_Default	VPN User Group	-	Edit  Delete

4. Configure the parameters in the **Add User Group** window, and click **Save**.

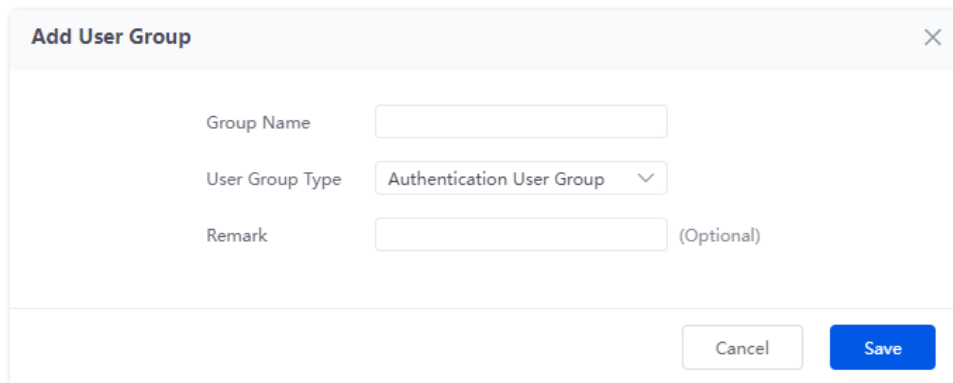

**Add User Group** [Close]

Group Name

User Group Type

Remark  (Optional)

Cancel Save

----End

### Parameter description

Parameter	Description
Group Name	Specifies the name of the user group policy.
User Group Type	<p>Specifies the type of the user group, including <b>Authentication User Group</b> and <b>VPN User Group</b>.</p> <p> Tip</p> <ul style="list-style-type: none"><li>After a user group whose <b>User Group Type</b> is set to <b>Authentication User Group</b> is referenced by <a href="#">account management</a>, all users who are authenticated with these user names and passwords will belong to this user group.</li><li>After a user group whose <b>User Group Type</b> is set to <b>VPN User Group</b> is referenced by <a href="#">user management</a>, all users who use these user names and passwords to perform VPN dial-up will belong to this user group.</li></ul>
Remark	Specifies the remark of the user group policy.

## 9.2 Filtering

### 9.2.1 IP address filtering

#### Overview

[Log in to the web UI of the router](#), and navigate to **Audit > Filtering > IP address Filtering** to enter the page.

On this page, you can configure the IP address filtering rules to allow or block the LAN hosts to connect to the router for the internet.

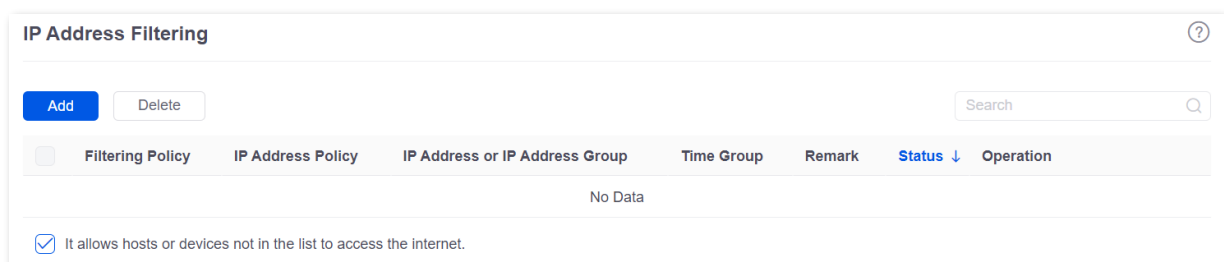

You can click **Add** to add a new IP address filtering policy.

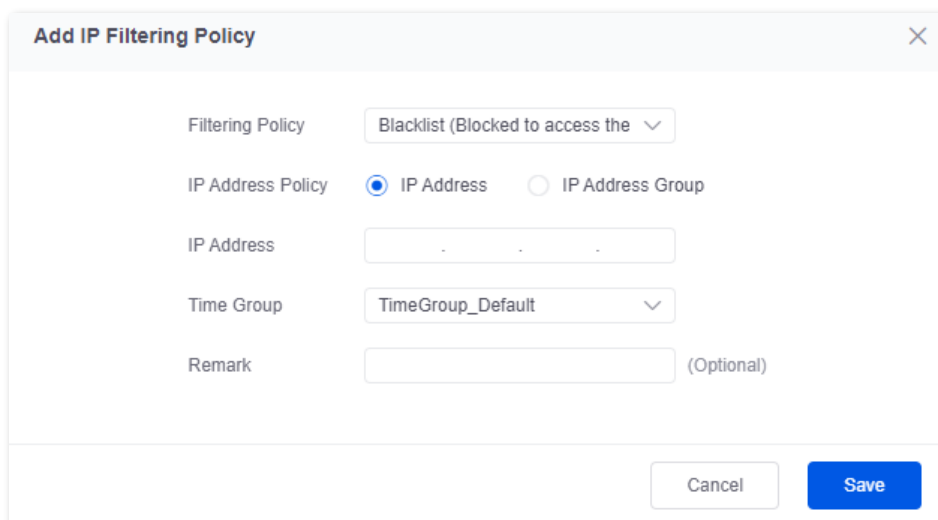







The screenshot shows the 'Add IP Filtering Policy' dialog box. It contains the following fields and options:

- Filtering Policy: Blacklist (Blocked to access the ...)
- IP Address Policy:  IP Address  IP Address Group
- IP Address: [Empty text input field]
- Time Group: TimeGroup\_Default
- Remark: [Empty text input field] (Optional)

At the bottom right, there are 'Cancel' and 'Save' buttons.

## Parameter description

Parameter	Description
Filtering Policy	<p>Specifies the mode of the IP address filtering policy.</p> <ul style="list-style-type: none"> <li>– <b>Blacklist (Blocked to access the internet):</b> The user with the specified IP address is blocked to access the internet during the specified period, and is allowed to access the internet during other times.</li> <li>– <b>White List (Allowed to access the internet):</b> The user with the specified IP address is allowed to access the internet during the specified period, and is blocked from accessing the internet during other times.</li> </ul>
IP Address Policy	To filter one IP address, select <b>IP Address</b> and enter the IP address.
IP Address or IP Address Group	<p>To filter one or more IP address groups, select <b>IP Address Group</b> and select the corresponding IP group policy you set.</p> <p> <b>Note</b></p> <p>The IP group should be configured in <a href="#">IP Group</a> in advance.</p>
Time Group	<p>Used to select the time group policy upon which the IP address filtering policy takes effect.</p> <p> <b>Note</b></p> <p>The time group should be configured in <a href="#">Time Group</a> in advance.</p>
Remark	Specifies the remark of the IP address filtering policy. The remark is optional.
Status	Specifies the status of the IP address filtering policy including <b>Enabled</b> or <b>Disabled</b> .
Operation	<p>Used to edit, enable, disable or delete the IP address filtering policy.</p> <ul style="list-style-type: none"> <li> <b>Edit</b>: Used to modify the IP address filtering policy.</li> <li> <b>Enable</b>: Used to enable the IP address filtering policy.</li> <li> <b>Disable</b>: Used to disable the IP address filtering policy.</li> <li> <b>Delete</b>: Used to delete the IP address filtering policy.</li> </ul>
It allows hosts or devices not in the list to access the internet.	<ul style="list-style-type: none"> <li>– When Selected: The devices not in the filtering list or devices with the filtering policy disabled can access the internet.</li> <li>– When Deselected: The devices not in the filtering list or devices with the filtering policy disabled cannot access the internet.</li> </ul> <p> <b>Note</b></p> <p>To deselect this function, configure a whitelist first.</p>

## Example of configuring IP address filtering

### Networking requirements

An enterprise uses the enterprise router to deploy a network.

Requirements: During business hours (8:00 – 18:00 from Monday to Friday), only purchasing staff can access the internet while other staff cannot access the internet.

### Solution

The router's IP address filtering function can achieve the requirements. Assume that the IP addresses of the purchasing staff's computers range from 192.168.0.2 - 192.168.0.50.

### Configuration procedure

Configure the time group

Configure the IP group

Add the IP address filtering policy

1. [Log in to the web UI of the router.](#)

2. Configure the time group.

Navigate to **Audit > Group Policy > Time Group**, and click **Add** to configure the following time group.

**Edit Time Group** [X]

Policy Name: Business Hours

Time Period 1: 08:00 → 18:00 [Clock]

Time Period 2: Start Time → End Time [Clock] (Optional)

Time Period 3: Start Time → End Time [Clock] (Optional)

Cycle: [Dropdown: Every Day]

Mon.  Tues.  Wed.  Thur.  
 Fri.  Sat.  Sun.

Remark: [Text Box] (Optional)

[Cancel] [Save]

3. Configure the IP group.

Navigate to **Audit > Group Policy > IP Group**, and click **Add** to configure the following IP group.



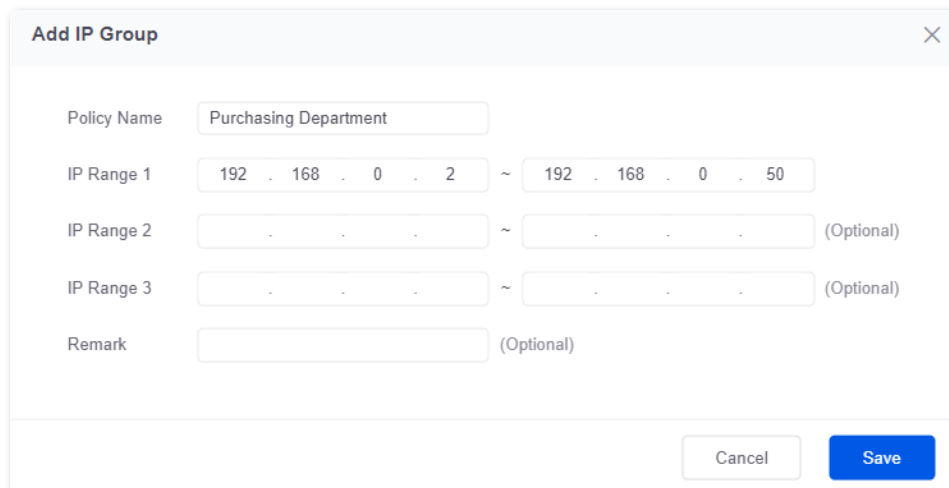

The 'Add IP Group' dialog box contains the following fields:

- Policy Name: Purchasing Department
- IP Range 1: 192 . 168 . 0 . 2 ~ 192 . 168 . 0 . 50
- IP Range 2: (Optional)
- IP Range 3: (Optional)
- Remark: (Optional)

Buttons: Cancel, Save

#### 4. Add the IP address filtering policy.

- 1) Navigate to **Audit > Filtering > IP Address Filtering**, and click **Add**.

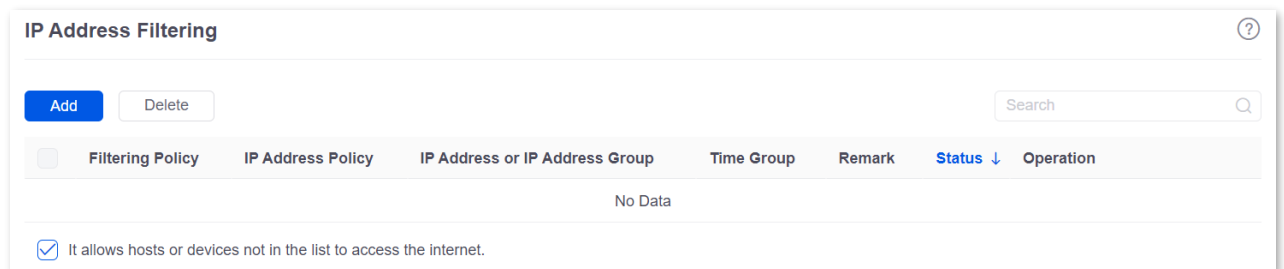

The 'IP Address Filtering' table is currently empty. It has columns for Filtering Policy, IP Address Policy, IP Address or IP Address Group, Time Group, Remark, Status, and Operation. A checkbox at the bottom is checked, indicating that hosts or devices not in the list can access the internet.

- 2) Configure the parameters in the **Add IP Filtering Policy** window, and click **Save**.

- Select the **Filtering Policy**, which is **White List (Allowed to access the internet)** in this example.
- Select **IP Address Group** for **IP Address Policy**.
- Select the **IP Group** upon which the policy takes effect, which is **Purchasing Department** in this example.
- Select the **Time Group** upon which the policy takes effect, which is **Business Hours** in this example.

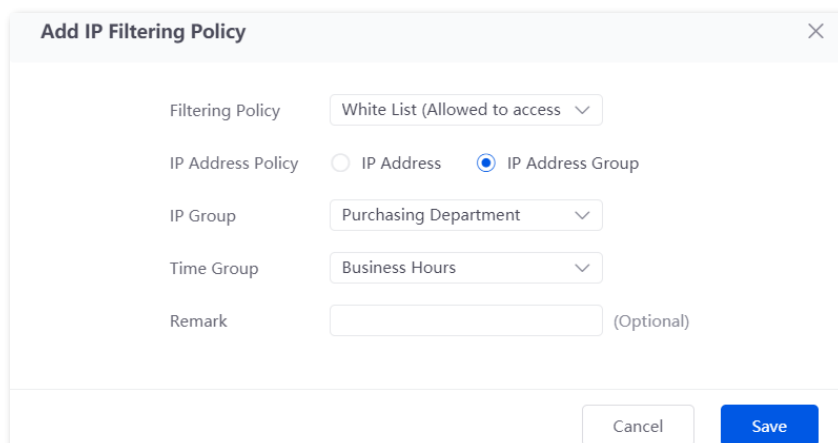

The 'Add IP Filtering Policy' dialog box contains the following fields:

- Filtering Policy: White List (Allowed to access)
- IP Address Policy:  IP Address,  IP Address Group
- IP Group: Purchasing Department
- Time Group: Business Hours
- Remark: (Optional)

Buttons: Cancel, Save

- 3) Deselect **It allows hosts or devices not in the list to access the internet**. In the displayed dialog box, click **OK**.

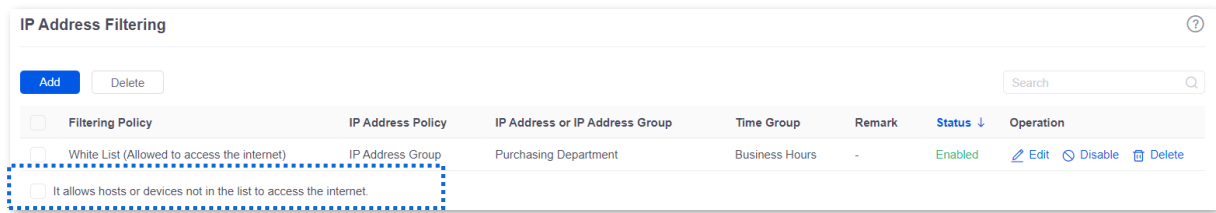

----End

## Verification

Only the computers of the purchasing staff (IP address range: 192.168.0.2 – 192.168.0.50) in the LAN can access the internet while other staff cannot access the internet at 8:00 – 18:00 from Monday to Friday.

## 9.2.2 MAC address filtering

### Overview



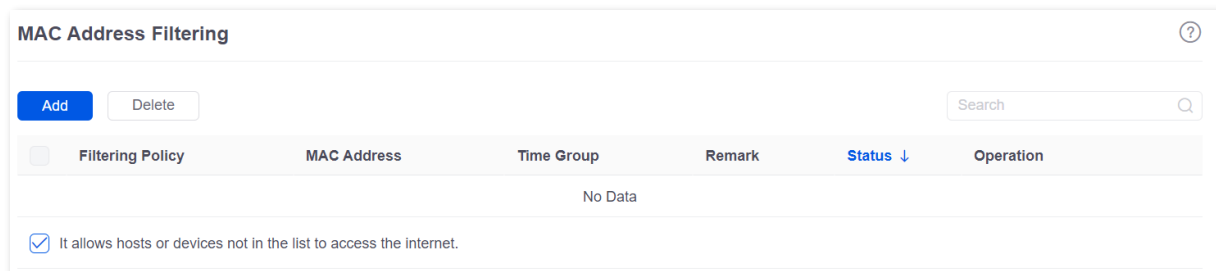

[Log in to the web UI of the router](#), and navigate to **Audit > Filtering > MAC Address Filtering** to enter the page.

You can configure the MAC address filtering rules to allow or block the LAN hosts to connect to the router for the internet.



You can click **Add** to add a new MAC address filtering policy.

### Parameter description

Parameter	Description
Filtering Policy	<p>Specifies the mode of the MAC address filtering policy.</p> <ul style="list-style-type: none"> <li>- <b>Blacklist (Blocked to access the internet):</b> The user with the specified MAC address is blocked to access the internet during the specified period, and is allowed to access the internet during other times.</li> <li>- <b>White List (Allowed to access the internet):</b> The user with the specified MAC address is allowed to access the internet during the specified period, and is blocked from accessing the internet during other times.</li> </ul>
MAC Address	Specifies the MAC address in the <b>Blacklist</b> or <b>Whitelist</b> .
Time Group	<p>Used to select the time group policy upon which the MAC address filtering policy takes effect.</p> <p> <b>Note</b></p> <p>The time group should be configured in <a href="#">Time Group</a> in advance.</p>
Remark	Specifies the remark of the MAC address filtering policy. The remark is optional.
Status	Specifies the status of the MAC address filtering policy including <b>Enabled</b> or <b>Disabled</b> .
Operation	<p>Used to edit, enable, disable, or delete the MAC address filtering policy.</p> <ul style="list-style-type: none"> <li> <b>Edit</b>: Used to modify the MAC address filtering policy.</li> <li> <b>Enable</b>: Used to enable the MAC address filtering policy.</li> <li> <b>Disable</b>: Used to disable the MAC address filtering policy.</li> <li> <b>Delete</b>: Used to delete the MAC address filtering policy.</li> </ul>

Parameter	Description
It allows hosts or devices not in the list to access the internet.	<ul style="list-style-type: none"><li>– When Selected: The devices not in the filtering list or devices with the filtering policy disabled can access the internet.</li><li>– When Deselected: The devices not in the filtering list or devices with the filtering policy disabled cannot access the internet.</li></ul>

 **Note**

To deselect this function, configure a whitelist first.

## Example of configuring MAC address filtering

### Networking requirements

An enterprise uses the enterprise router to deploy a network.

Requirements: During business hours (8:00 – 18:00 from Monday to Friday), only a purchasing staff can access the internet while other staff cannot access the internet.

### Solution

The router's MAC address filtering function can achieve the requirements. Assume that the MAC address of the purchasing staff's computer is CC:3A:61:71:1B:6E.

### Configuration procedure

Configure the time group

Add the MAC address filtering policy

1. [Log in to the web UI of the router.](#)
2. Configure the time group.

Navigate to **Audit > Group Policy > Time Group**, and click **Add** to configure the following time group.

**Edit Time Group**

Policy Name: Business Hours

Time Period 1: 08:00 → 18:00

Time Period 2: Start Time → End Time (Optional)

Time Period 3: Start Time → End Time (Optional)

Cycle: Every Day

Mon.  Tues.  Wed.  Thur.

Fri.  Sat.  Sun.

Remark: (Optional)

Cancel Save

3. Add the MAC address filtering policy.

- 1) Navigate to **Audit > Filtering > MAC Address Filtering**, and click **Add**.
- 2) Configure the parameters in the **Add MAC Filtering Policy** window, and click **Save**.
  - Select the **Filtering Policy**, which is **White List (Allowed to access the internet)** in this example.
  - Enter the **MAC Address** allowed to access the internet, which is **CC:3A:61:71:1B:6E** in this example.
  - Select the **Time Group** upon which the policy takes effect, which is **Business Hours** in this example.



If you need to filter multiple MAC addresses, use semicolons (;) to separate them.

---

**Add MAC Filtering Policy**

Filtering Policy: White List (Allowed to access)

MAC Address: CC:3A:61:71:1B:6E

Time Group: Business Hours

Remark: (Optional)

Buttons: Cancel, Save

- 3) Deselect **It allows hosts or devices not in the list to access the internet**. In the displayed dialog box, click **OK**.

**MAC Address Filtering**

Buttons: Add, Delete

Filtering Policy	MAC Address	Time Group	Remark	Status ↓	Operation
<input type="checkbox"/> White List (Allowed to access the internet)	CC:3A:61:71:1B:6E	Business Hours	-	Enabled	<a href="#">Edit</a> <a href="#">Disable</a> <a href="#">Delete</a>
<input type="checkbox"/> It allows hosts or devices not in the list to access the internet.					

----End

## Verification

Only a purchasing staff using the computer with a MAC address of CC:3A:61:71:1B:6E in the LAN can access the internet while other staff cannot access the internet at 8:00 – 18:00 from Monday to Friday.

## 9.2.3 Port filtering

### Overview

Application protocols for internet services have specific port numbers. 0 to 1023 are port numbers for some common services. These ports are generally fixed to specific services.

[Log in to the web UI of the router](#), and navigate to **Audit > Filtering > Port Filtering** to enter the page.

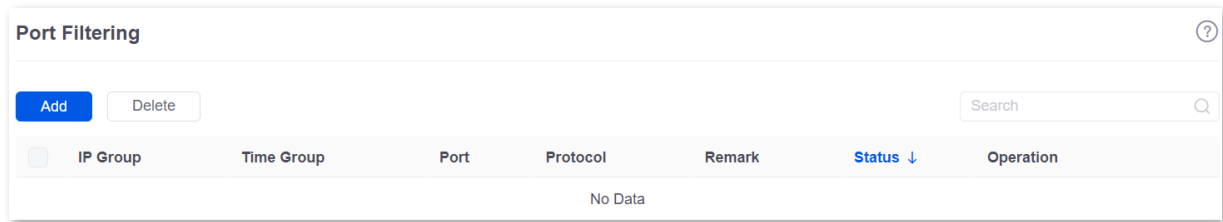

On this page, you can control users' access to certain types of internet services by forbidding their access to the specified service ports.



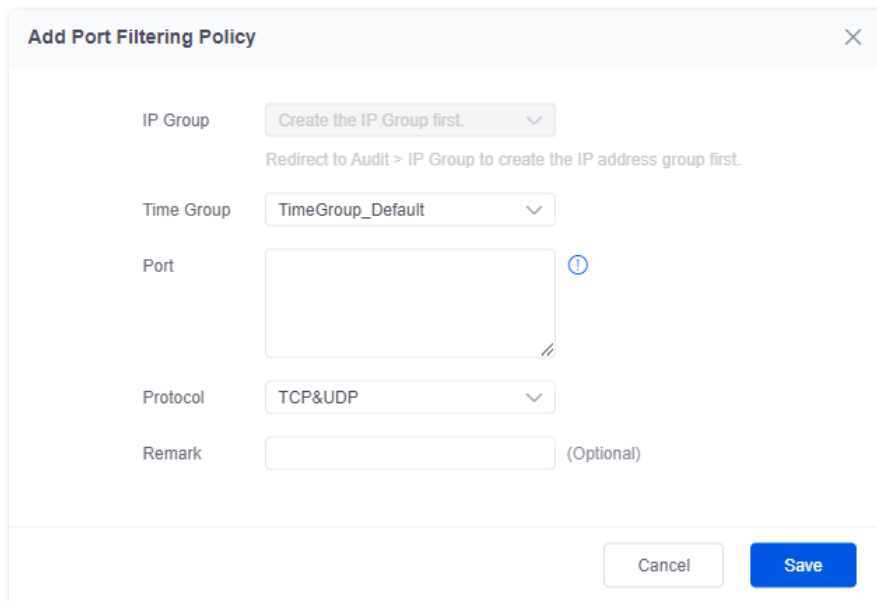



You can click **Add** to add a new port filtering policy.



### Parameter description

Parameter	Description
IP Group	<p>Used to select the IP address group policy upon which the port filtering policy takes effect.</p> <p> <b>Note</b></p> <p>The IP address group should be configured in <a href="#">IP Group</a> in advance.</p>
Time Group	<p>Used to select the time group policy upon which the port filtering policy takes effect.</p> <p> <b>Note</b></p> <p>The time group should be configured in <a href="#">Time Group</a> in advance.</p>
Port	Specifies the service port forbidden to access.
Protocol	Specifies the service protocol forbidden to access.
Remark	Specifies the remark of the port filtering policy. The remark is optional.

Parameter	Description
Status	Specifies the status of the port filtering policy including <b>Enabled</b> or <b>Disabled</b> .
Operation	Used to edit, enable, disable or delete the port filtering policy.  <b>Edit</b> : Used to modify the port filtering policy.  <b>Enable</b> : Used to enable the port filtering policy.  <b>Disable</b> : Used to disable the port filtering policy.  <b>Delete</b> : Used to delete the port filtering policy.

## Example of configuring port filtering

### Networking requirements

An enterprise uses the enterprise router to deploy a network.

Requirements: During business hours (8:00 – 18:00 from Monday to Friday), purchasing staff are forbidden to browse webpages (The default port number for webpage browsing is 80.).

### Solution

The router's port filtering function can achieve the requirements. Assume that the IP address of the purchasing staff's computers ranges from 192.168.0.2 – 192.168.0.50.

### Configuration procedure

Configure the time group

Configure the IP group

Add the port filtering policy

1. [Log in to the web UI of the router.](#)
2. Configure the time group.

Navigate to **Audit > Group Policy > Time Group**, and click **Add** to configure the following time group.



**Edit Time Group**

Policy Name: Business Hours

Time Period 1: 08:00 → 18:00

Time Period 2: Start Time → End Time (Optional)

Time Period 3: Start Time → End Time (Optional)

Cycle:  Every Day

Mon.  Tues.  Wed.  Thur.

Fri.  Sat.  Sun.

Remark: (Optional)

Cancel Save

3. Configure the IP group.

Navigate to **Audit > Group Policy > IP Group**, and click **Add** to configure the following IP group.

**Add IP Group**

Policy Name: Purchasing Department

IP Range 1: 192 . 168 . 0 . 2 ~ 192 . 168 . 0 . 50

IP Range 2: (Optional)

IP Range 3: (Optional)

Remark: (Optional)

Cancel Save

4. Add the port filtering policy.

- 1) Navigate to **Audit > Filtering > Port Filtering**, and click **Add**.
- 2) Configure the parameters in the **Add Port Filtering Policy** window, and click **Save**.
  - Select the **IP Group** upon which the policy takes effect, which is **Purchasing Department** in this example.
  - Select the **Time Group** upon which the policy takes effect, which is **Business Hours** in this example.
  - Enter the **Port** number for webpage browsing, which is **80** in this example.

- Select the **Protocol** used by the service. It is recommended to keep the default **TCP&UDP**.



- If you need to filter multiple non-consecutive ports, use semicolons (;) to separate them, such as **80;20**.
- If you need to filter multiple consecutive ports, use tildes (~) to connect them, such as **75~80**.

----End

## Verification

Purchasing staff using computers with IP addresses ranging from 192.168.0.2 – 192.168.0.50 in the LAN cannot browse webpages at 8:00 – 18:00 from Monday to Friday.

## 9.2.4 URL filtering

### Overview

[Log in to the web UI of the router](#), and navigate to **Audit > Filtering > URL Filtering** to enter the page.

On this page, you can allow or block users to access specified websites to regulate users' online behavior in the LAN.

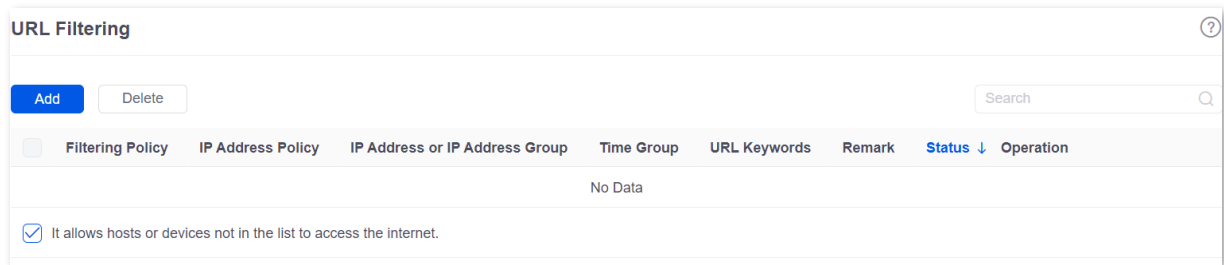



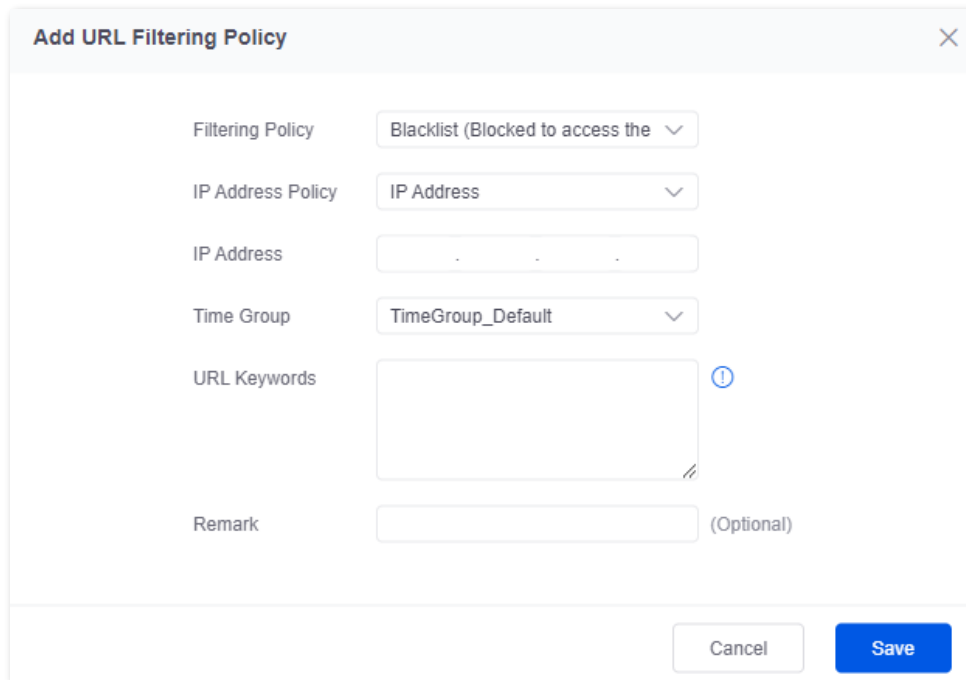



You can click **Add** to add a new URL filtering policy.



### Parameter description

Parameter	Description
Filtering Policy	<p>Specifies the mode of the URL filtering policy.</p> <ul style="list-style-type: none"> <li>– <b>Blacklist (Blocked to access the internet):</b> The user with the specified IP address is only blocked to access specified websites during the specified period, and is allowed to access all websites during other times.</li> <li>– <b>White List (Allowed to access the internet):</b> The user with the specified IP address is only allowed to access specified websites during the specified period, and is allowed to access all websites during other times.</li> </ul>
IP Address Policy	To filter one IP address, select <b>IP Address</b> and enter the IP address.
IP Address or IP Address Group	To filter one or more IP address groups, select <b>IP Address Group</b> and select the corresponding IP group policy you set.
	<p> <b>Note</b></p> <p>The IP group should be configured in <a href="#">IP Group</a> in advance.</p>

Parameter	Description
	Used to select the time group policy upon which the URL filtering policy takes effect.
Time Group	 Note The time group should be configured in <a href="#">Time Group</a> in advance.
URL Keywords	Specifies the keywords of the URL forbidden or allowed to access.
Remark	Specifies the remark of the URL filtering policy. The remark is optional.
Status	Specifies the status of the URL filtering policy including <b>Enabled</b> or <b>Disabled</b> .
	Used to edit, enable, disable, or delete the URL filtering policy.
Operation	 <b>Edit</b> : Used to modify the URL filtering policy.  <b>Enable</b> : Used to enable the URL filtering policy.  <b>Disable</b> : Used to disable the URL filtering policy.  <b>Delete</b> : Used to delete the URL filtering policy.
It allows hosts or devices not in the list to access the internet.	<ul style="list-style-type: none"> <li>When Selected: The devices not in the filtering list or devices with the filtering policy disabled can access the specified websites.</li> <li>When Deselected: The devices not in the filtering list or devices with the filtering policy disabled cannot access the specified websites.</li> </ul>
	 Note To deselect this function, configure a whitelist first.

## Example of configuring URL filtering

### Networking requirements

An enterprise uses the enterprise router to deploy a network.

Requirements: During business hours (8:00 – 18:00 from Monday to Friday), only designers can access some websites for designing, such as Pinterest (pinterest.com), Behance (behance.net) and Dribbble (dribbble.com), while other staff cannot access the internet.

### Solution

The router's URL filtering function can achieve the requirements. Assume that the IP addresses of designers' computers range from 192.168.0.60 - 192.168.0.100.

### Configuration procedure



1. [Log in to the web UI of the router.](#)
2. Configure the time group.

Navigate to **Audit > Group Policy > Time Group**, and configure displayed time group.

The 'Edit Time Group' window shows the following configuration:

- Policy Name: Business Hours
- Time Period 1: 08:00 → 18:00
- Time Period 2: Start Time → End Time (Optional)
- Time Period 3: Start Time → End Time (Optional)
- Cycle:  Every Day,  Mon.,  Tues.,  Wed.,  Thur.,  Fri.,  Sat.,  Sun.
- Remark: (Optional)

Buttons: Cancel, Save

3. Configure the IP group.

Navigate to **Audit > Group Policy > IP Group**, and click **Add** to configure the following IP group.

The 'Add IP Group' window shows the following configuration:

- Policy Name: Design Department
- IP Range 1: 192 . 168 . 0 . 60 ~ 192 . 168 . 0 . 100
- IP Range 2: . . . ~ . . . (Optional)
- IP Range 3: . . . ~ . . . (Optional)
- Remark: (Optional)

Buttons: Cancel, Save

4. Add the URL filtering policy.

- 1) Navigate to **Audit > Filtering > URL Filtering**, and click **Add**.
- 2) Configure the parameters in the **Add URL Filtering Policy** window, and click **Save**.
  - Select the **Filtering Policy**, which is **White List (Allowed to access the internet)** in this example.
  - Select **IP Address Group** for **IP Address Policy**.

- Select the **IP Group** upon which the policy takes effect, which is **Design Department** in this example.
- Select the **Time Group** upon which the policy takes effect, which is **Business Hours** in this example.
- Enter the **URL Keywords**, which are **pinterest.com;behance.net;dribbble.com** in this example.

**Add URL Filtering Policy**

Filtering Policy: White List (Allowed to access th

IP Address Policy: IP Address Group

IP Group: Design Department

Time Group: Business Hours

URL Keywords: pinterest.com;behance.net;dribbble.com

Remark: (Optional)

Buttons: Cancel, Save

- 3) Deselect **It allows hosts or devices not in the list to access the internet**. In the displayed dialog box, click **OK**.

Filtering Policy	IP Address Policy	IP Address or IP Address Group	Time Group	URL Keywords	Remark	Status	Operation
<input type="checkbox"/> White List (Allowed to access the Internet)	IP Address Group	Design Department	Business Hours	pinterest.com;behance.net;dribbble.com	-	Enabled	<a href="#">Edit</a> <a href="#">Disable</a> <a href="#">Delete</a>
<input type="checkbox"/> It allows hosts or devices not in the list to access the Internet							

1 items in total

----End

## Verification

Only computers of designers (IP address range: 192.168.0.60 – 192.168.0.100) in the LAN can access the websites of pinterest.com, behance.net and dribbble.com while other computers cannot access the internet at 8:00 – 18:00 from Monday to Friday.

## 9.2.5 Wireless MAC filtering

### Overview

[Log in to the web UI of the router](#), and navigate to **Audit > Filtering > Wireless MAC Filtering** to enter the page.



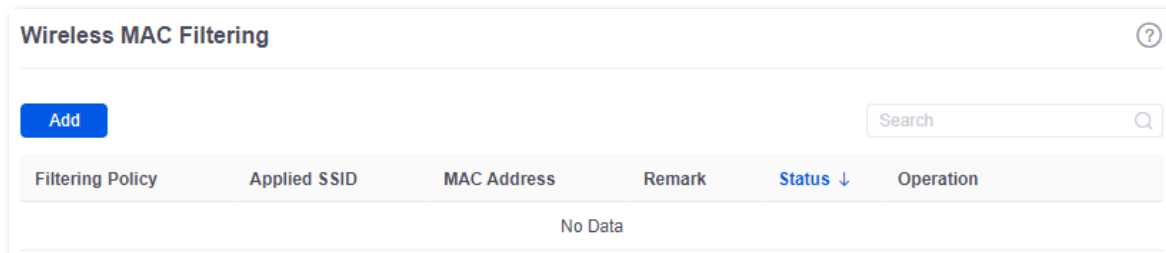

On this page, you can allow or block mobile users in the LAN to connect to specified wireless networks based on their wireless MAC addresses.



You can click **Add** to add a new wireless MAC filtering policy.

### Parameter description

Parameter	Description
Filtering Policy	<p>Specifies the mode of the wireless MAC address filtering policy.</p> <ul style="list-style-type: none"><li>– <b>Blacklist (prohibit to access the Wi-Fi network):</b> The user with the specified MAC address is blocked to access the internet through the specified SSID during the specified period, and is allowed to access the internet through the SSID during other times.</li><li>– <b>Whitelist (allow to access the Wi-Fi network):</b> The user with the specified MAC address is allowed to access the internet through the specified SSID during the specified period, and is blocked from accessing the internet through the SSID during other times.</li></ul>

Parameter	Description
Applied SSID	Used to select the SSID policy upon which the wireless MAC address filtering policy takes effect. The SSID policy should be configured in the <a href="#">SSID Policy</a> in advance.
MAC Address	Specifies the MAC address to be filtered.
Remark	Specifies the remark of the wireless MAC address filtering policy. The remark is optional.
Status	Specifies the status of the wireless MAC address filtering policy including <b>Enabled</b> and <b>Disabled</b> .
Operation	Used to edit, enable, disable, or delete the wireless MAC filtering policy.  <b>Edit</b> : Used to modify the wireless MAC filtering policy.  <b>Enable</b> : Used to enable the wireless MAC filtering policy.  <b>Disable</b> : Used to disable the wireless MAC filtering policy.  <b>Delete</b> : Used to delete the wireless MAC filtering policy.

## Example of configuring wireless MAC filtering

### Networking requirements

An enterprise uses the router to set up a network. The router is connected to an AP (managed by the router), and already delivers the wireless network named VIP to the AP.

Requirement: The wireless network of VIP only opens access to several devices.

### Solution

The router's wireless MAC filtering function can achieve the requirements. Assume that only 3 wireless devices are allowed to connect to the wireless network of VIP during business hours. The MAC addresses are D8:38:0D:00:00:01, D8:38:0D:00:00:02 and D8:38:0D:00:00:03.

### Configuration procedure

1. [Log in to the web UI of the router.](#)
2. Add the wireless MAC filtering policy.
  - 1) Navigate to **Audit > Filtering > Wireless MAC Filtering**, and click **Add**.
  - 2) Configure the parameters in the **Add Wireless MAC Filtering Policy** window, and click **Save**.
    - Select the **Filtering Policy**, which is **Whitelist (allow to access the Wi-Fi network)** in this example.



- Select the **Applied SSID**, which is **VIP** (set in advance) in this example.
- Enter the **MAC Addresses** upon which the policy takes effect, which are **D8:38:0D:00:00:01;D8:38:0D:00:00:02;D8:38:0D:00:00:03** in this example.

**Add Wireless MAC Filtering Policy**

Filtering Policy: Whitelist (allow to access the W)

Applied SSID: VIP

MAC Address: D8:38:0D:00:00:01;D8:38:0D:00:00:02;D8:38:0D:00:00:03

Remark: (Optional)

Buttons: Cancel, Save

----End

## Verification

Only the above wireless devices can connect to the network of VIP while other devices cannot.

## 9.2.6 User filtering

### Overview

[Log in to the web UI of the router](#), and navigate to **Audit > Filtering > User Filtering** to enter the page.

On this page, you can allow or block authenticated users in the LAN to connect to the internet based on users and user groups.

**User Filtering**

Buttons: Add, Search





Filtering Policy	User Policy	User/User Group	Time Group	Remark	Status ↓	Operation
No Data						

It allows hosts or devices not in the list to access the internet.

You can click **Add** to add a new user filtering policy.

### Parameter description

Parameter	Description
Filtering Policy	<p>Specifies the mode of the user filtering policy.</p> <ul style="list-style-type: none"> <li>- <b>Blacklist (Blocked to access the internet):</b> The specified user or user group is blocked to access the internet during the specified period, and is allowed to access the internet during other times.</li> <li>- <b>White List (Allowed to access the internet):</b> The specified user or user group is allowed to access the internet during the specified period, and is blocked from accessing the internet during other times.</li> </ul>
User Policy	<p>Used to select the user policy (authenticated user or user group) upon which the user filtering policy takes effect.</p> <p>The authenticated user should be configured in <a href="#">Account Management</a> in advance, and the authenticated user group should be configured in <a href="#">User Group</a> in advance.</p>
User/User Group	Specifies the authenticated user or user group to be filtered.
User Name	Specifies the user name of the authenticated user.
Time Group	<p>Used to select the time group upon which the user filtering policy takes effect.</p> <p>The time group should be configured in <a href="#">Time Group</a> in advance.</p>
Remark	Specifies the remark of the user filtering policy. The remark is optional.
Status	Specifies the status of the user filtering policy, including <b>Enabled</b> and <b>Disabled</b> .

Parameter	Description
	Used to edit, enable, disable, or delete the user filtering policy.
	 <b>Edit</b> : Used to modify the user filtering policy.
Operation	 <b>Enable</b> : Used to enable the user filtering policy.
	 <b>Disable</b> : Used to disable the user filtering policy.
	 <b>Delete</b> : Used to delete the user filtering policy.
It allows hosts or devices not in the list to access the internet.	<ul style="list-style-type: none"><li>- When Selected: The devices not in the filtering list or devices with the filtering policy disabled can access the internet.</li><li>- When Deselected: The devices not in the filtering list or devices with the filtering policy disabled cannot access the internet.</li></ul>
	 <b>Note</b>
	To deselect this function, configure a whitelist first.

## Example of configuring user filtering

### Networking requirements

An enterprise uses the router to set up a network. The enterprise has configured the account authentication, and the account has been added to the authenticated user group of R&D Department. Refer to [Authentication](#) for specific instructions.

Requirement: During business hours (8:00 -18:00 from Monday to Friday), only the staff of R&D Department authenticated through the user name and password can access the internet while other staff cannot.

### Solution

The router's user filtering function can achieve the requirements.

### Configuration procedure

Configure the time group

Add the user filtering policy

1. [Log in to the web UI of the router.](#)

2. Configure the time group.

Navigate to **Audit > Group Policy > Time Group**, and click **Add** to configure the following time group.

**Add Time Group**

Policy Name: Business Hours

Time Period 1: 08:00 → 18:00

Time Period 2: Start Time → End Time (Optional)

Time Period 3: Start Time → End Time (Optional)

Cycle:  Every Day

Mon.  Tues.  Wed.  Thur.

Fri.  Sat.  Sun.

Remark: (Optional)

Cancel Save

3. Add the user filtering policy.

- 1) Navigate to **Audit > Filtering > User Filtering**, and click **Add**.
- 2) Configure the parameters in the **Add User Filtering Policy** window, and click **Save**.
  - Select the **Filtering Policy**, which is **White List (Allowed to access the internet)** in this example.
  - Select **User Group** for **User Policy**.
  - Select the **User Group** upon which the policy takes effect, which is **R&D Department** (set in advance) in this example.
  - Select the **Time Group** upon which the policy takes effect, which is **Business Hours** in this example.

**Add User Filtering Policy**

Filtering Policy: White List (Allowed to access th)

User Policy:  User  User Group

User Group: R&D Department

Time Group: Business Hours

Remark: (Optional)

Cancel Save

- 3) Deselect **It allows hosts or devices not in the list to access the internet**. In the pop-up window, click **OK**.

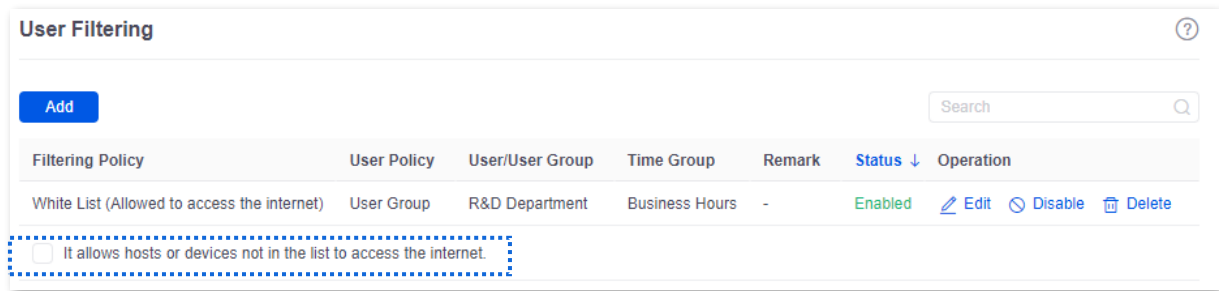

----End

## Verification

During business hours (8:00 -18:00 from Monday to Friday), only the staff of R&D Department authenticated through the user name and password can access the internet while other staff cannot.

## 9.2.7 VPN access permission

### Overview

[Log in to the web UI of the router](#), and navigate to **Audit > Filtering > VPN Access Permission** to enter the page.

On this page, you can configure VPN access permissions rules to allow or block VPN users from accessing servers in the LAN.

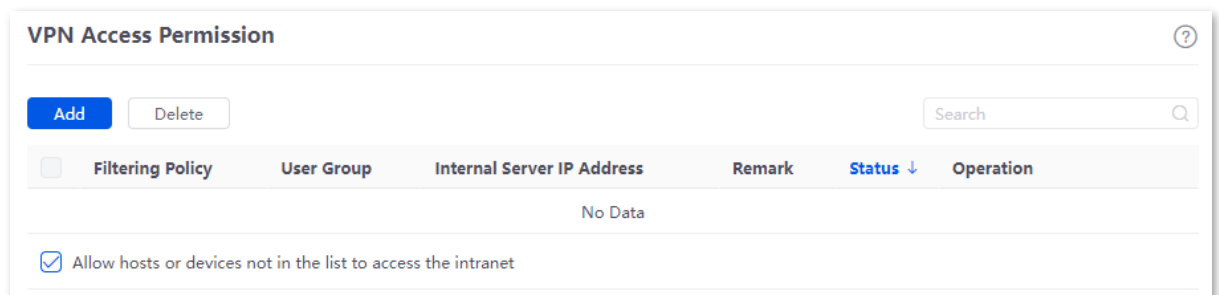

You can click **Add** to add a new VPN access permission policy.

### Parameter description

Parameter	Description
Filtering Policy	<p>Specifies the mode of the VPN access permission policy.</p> <ul style="list-style-type: none"> <li>– <b>Blacklist (Blocked to access):</b> The specified VPN user group is blocked to access specified servers in the LAN.</li> <li>– <b>Whitelist (Allowed to access):</b> The specified VPN user group is allowed to access the specified servers in the LAN.</li> </ul>
User Group	Specifies the VPN user group for which the VPN access permission policy takes effect.
Internal Server IP Address	Specifies the internal server IP address for which the VPN access permission policy takes effect.
Remark	Specifies the remark of the VPN access permission policy. The remark is optional.
Status	Specifies the status of the VPN access permission policy including <b>Enabled</b> or <b>Disabled</b> .
Operation	<p>Used to edit, enable, disable or delete the VPN access permission policy.</p> <ul style="list-style-type: none"> <li> <b>Edit</b>: Used to modify the VPN access permission policy.</li> <li> <b>Enable</b>: Used to enable the VPN access permission policy.</li> <li> <b>Disable</b>: Used to disable the VPN access permission policy.</li> <li> <b>Delete</b>: Used to delete the VPN access permission policy.</li> </ul>

Parameter	Description
	When Selected: The devices not in the list or devices with the policy disabled can access the intranet server.
Allow hosts or devices not in the list to access the intranet	When Deselected: The devices not in the list or devices with the policy disabled cannot access the intranet server.
	 Note
	To deselect this function, configure a whitelist first.

## Example of configuring VPN access permission

### Networking requirements

An enterprise uses the enterprise router to set up a network.

The enterprise has established a PPTP VPN between the enterprise's headquarters and subsidiary 1 through the router. The headquarters has created the [VPN user group](#) named **Subsidiary 1 Staff** on the router, and [has added the user names and passwords of subsidiary 1 staff to the VPN user group](#). If you want to check the specific configuration of VPN, refer to [VPN service](#).

Requirements: Only subsidiary 1 staff are allowed to access the headquarters FTP server through PPTP VPN, and other staff cannot access it.

### Solution

The router's VPN access permission function can achieve the requirements. Assume that the IP address of the headquarters FTP server is 192.168.0.104.

### Configuration procedure

1. [Log in to the web UI of the router](#).
2. Add the VPN access permission policy.
  - 1) Navigate to **Audit > Filtering > VPN Access Permission**, and click **Add**.
  - 2) Configure the parameters in the **Add VPN Access Permission Policy** window, and click **Save**.
    - Select the **Filtering Policy**, which is **Whitelist (Allowed to access)** in this example.
    - Select the **User Group**, which is **Subsidiary 1 Staff** in this example.
    - Set **Internal Server IP Address**, which is **192.168.0.104** in this example.

**Add VPN Access Permission Policy**

Filtering Policy:

User Group:

Internal Server IP Address:  ⓘ

Remark:  (Optional)

- 3) Deselect **Allow hosts or devices not in the list to access the intranet**. In the displayed dialog box, click **OK**.

**VPN Access Permission**

<input type="checkbox"/>	Filtering Policy	User Group	Internal Server IP Address	Remark	Status ↓	Operation
<input checked="" type="checkbox"/>	Whitelist (Allowed to access)	Subsidiary 1 Staff	192.168.0.104	-	Enabled	<a href="#">Edit</a> <a href="#">Disable</a> <a href="#">Delete</a>
<input type="checkbox"/>	Allow hosts or devices not in the list to access the intranet					

1 items in total

----End

## Verification

Only the subsidiary 1 staff can access the FTP server with the headquarters IP address 192.168.0.104 through PPTP VPN, and other staff cannot access it.



## 9.3 Log auditing

### 9.3.1 Audit settings

[Log in to the web UI of the router](#), and navigate to **Audit > Log Audit > Audit Settings** to enter the page.

On this page, you can collect specified types of logs from the specified port as required.

This function is disabled by default. The following displays the page when the function is enabled.

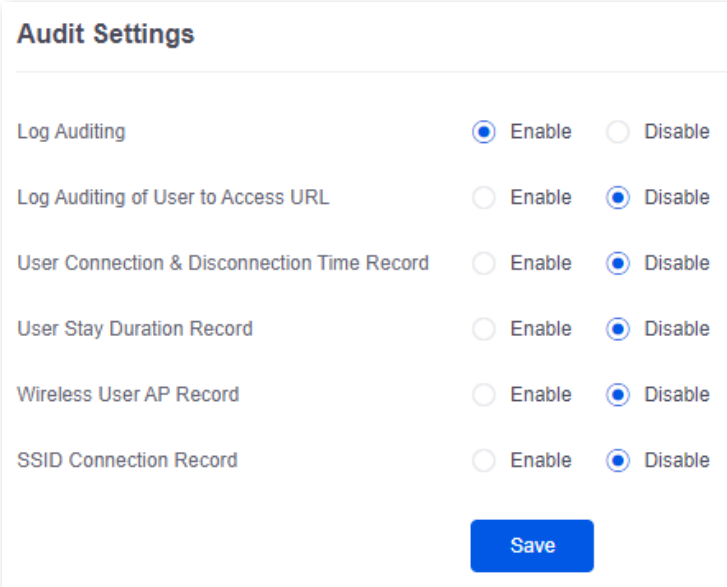

The screenshot shows the 'Audit Settings' page with the following options:

Parameter	Enable	Disable
Log Auditing	<input checked="" type="radio"/>	<input type="radio"/>
Log Auditing of User to Access URL	<input type="radio"/>	<input checked="" type="radio"/>
User Connection & Disconnection Time Record	<input type="radio"/>	<input checked="" type="radio"/>
User Stay Duration Record	<input type="radio"/>	<input checked="" type="radio"/>
Wireless User AP Record	<input type="radio"/>	<input checked="" type="radio"/>
SSID Connection Record	<input type="radio"/>	<input checked="" type="radio"/>

A 'Save' button is located at the bottom of the form.

#### Parameter description

Parameter	Description
Log Auditing	Used to enable or disable the log auditing function.
Log Auditing of User to Access URL	Used to enable or disable the function to record the information of web pages accessed by users.
User Connection & Disconnection Time Record	Used to enable or disable the function to record the time at which a user obtains an IP address from the user DHCP server.
User Stay Duration Record	Used to enable or disable the function to record the users' online duration.
Wireless User AP Record	Used to enable or disable the function to record the information about the AP connected to the wireless user.

Parameter	Description
SSID Connection Record	Used to enable or disable the function to record the name of the SSID connected to the wireless user.

## 9.3.2 Log storage

[Log in to the web UI of the router](#), and navigate to **Audit > Log Audit > Log Storage** to enter the page.

When the log auditing function is enabled, the result of log auditing can only be stored on the local PC or a USB disk. A log tool is required to be installed in the local computer, such as **Syslog**.

USB storage is enabled by default. The following displays the page when the function is enabled.

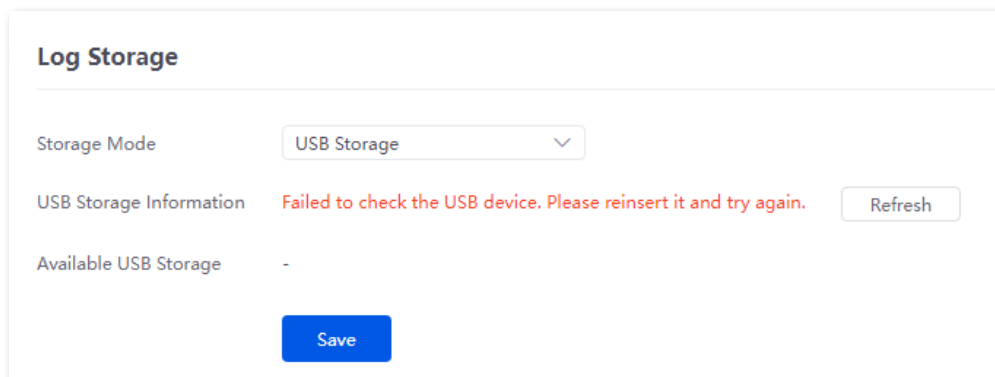

### Parameter description

Parameter	Description
	Specifies the mode of storage.
Storage Mode	<ul style="list-style-type: none"> <li>- <b>USB Storage:</b> Store the result of log auditing to other USB storage devices through USB ports.</li> <li>- <b>Local Computer Storage:</b> Store the result of log auditing on the local computer.</li> </ul>
USB Storage Information	Specifies the basic information of the USB storage device. When the <b>Storage Mode</b> is <b>USB Storage</b> , the system will automatically obtain the information.
Available USB Storage	Specifies the available storage space of the USB storage device. When the <b>Storage Mode</b> is <b>USB Storage</b> , the system will automatically scan the device.
Local Computer IP Address	Specifies the IP address of the local computer where the result of log auditing is stored. It is needed when the <b>Storage Mode</b> is <b>Local Computer Storage</b> .

# 10 More

## 10.1 Advanced routing

### 10.1.1 WAN parameters

[Log in to the web UI of the router](#), and navigate to **More > Advanced Routing > WAN Parameters** to enter the page. On this page, you can configure the parameters of the WAN port.

If you have completed the [Internet settings](#) correctly, but users of the router's LAN still cannot access the internet, or there is a problem with the internet, you can try to modify the WAN parameters to solve the problem.

WAN Parameters					
WAN Port	Rate	MTU	MAC Address	Operating Mode	Operation
WAN1	100 Mbps Full Duplex (Auto Negotiation)	1500	(Default MAC Address)	Internet	<a href="#">Edit</a>



#### Edit WAN1 Port Parameters

Rate: Auto Negotiation

MTU: 1500

MAC Address: Default MAC Address

Operating Mode: Internet



WAN Link Detection:  Enable  Disable

Detect Web Address: www.apple.com

Detection Interval: 10

## Parameter description

Parameter	Description
WAN Port	Specifies the WAN port of the router.
Rate	<p>Specifies the rate and duplex mode of the WAN port, which must be consistent with the rate and duplex mode of the WAN port at the peer side. Otherwise, the WAN port may fail to transmit and receive data normally.</p> <p>If the WAN port of the router is connected normally, but the corresponding interface light is not on. Or the interface light will on wait for a while (more than 5 seconds) after the Ethernet cable is plugged in. At this point, you can adjust the WAN port rate of the router to 10 Mbps half-duplex or 10 Mbps full-duplex to solve the problem.</p> <p>If you are uncertain about the rate and duplex mode of the WAN port of the peer side, select <b>Auto Negotiation</b>.</p>
MTU	<p>Maximum Transmission Unit (<b>MTU</b>) is the largest data packet that a network device transmits, and is related to the WAN port's connection type.</p> <p>Generally, keep the default value. If you cannot access some websites or cannot send and receive emails, you can try to modify the MTU value. The recommended modification range is 1400 to 1500. The following are scenarios where commonly used MTU apply:</p> <ul style="list-style-type: none"><li>- <b>1500</b>: Used for the most common settings in non-PPPoE connections and non-VPN connections.</li><li>- <b>1492</b>: Used for PPPoE connections.</li><li>- <b>1480</b>: It is the maximum value for the Ping function (packets larger than this value will be broken down).</li><li>- <b>1450</b>: Used for DHCP, which assigns dynamic IP addresses to connected devices.</li><li>- <b>1400</b>: Used for VPN or PPTP.</li></ul>
MAC Address	<p>Specifies the MAC address of the WAN port, which can be customized.</p> <p>After the networking is set up, if the router still cannot connect to the internet, the ISP may have bound the account to a certain MAC address. You can try to solve the problem by modifying the MAC address of the WAN port.</p> <ul style="list-style-type: none"><li>- <b>Default MAC Address</b>: The default value can be changed if the MAC address is set to <b>Customize</b>.</li><li>- <b>Customize</b>: You can customize the MAC address according to your needs.</li></ul>
Operating Mode	<p>Specifies the working mode of the WAN port.</p> <ul style="list-style-type: none"><li>- <b>Internet</b>: This mode is used as a normal WAN port to connect to the internet.</li><li>- <b>Local Network</b>: The WAN port cannot forward DNS requests, which means that the internet cannot be accessed. This mode is usually used for enterprise intranet.</li></ul>

Parameter	Description
WAN Link Detection	When the <b>WAN Link Detection</b> function is enabled, the router periodically detects the connectivity between <b>WAN Port</b> and <b>Detect Web Address</b> , and then selects the best WAN port link as the main egress link according to the detection results.
Detect Web Address	<p>Specifies the domain name that needs to be detected.</p> <p> <b>Note</b></p> <p>When the <b>WAN Link Detection</b> function is enabled, <b>Detect Web Address</b> can be configured.</p>
Detection Interval	<p>Specifies the interval to perform detections.</p> <p> <b>Note</b></p> <p>When the <b>WAN Link Detection</b> function is enabled, <b>Detection Interval</b> can be configured.</p>
Operation	<p> <b>Edit</b>: Used to modify the WAN parameters.</p>

## 10.1.2 Multi-WAN policy

### Overview

[Log in to the web UI of the router](#), and navigate to **More > Advanced Routing > Multi-WAN Policy** to enter the page. On this page, you can configure the multi-WAN policy and E-bank data based on source in&out.

### Multi-WAN policy

After the router enables multiple WAN ports, it can allow multiple broadband access at the same time to achieve bandwidth superposition. When multiple WAN ports are working at the same time, setting a reasonable multi-WAN policy can greatly improve the bandwidth utilization of the router.

- **Intelligent Load Balancing**: It indicates that data traffic is allocated automatically and the system will use the WAN port with the least traffic for communication automatically.
- **Customize**: Users can designate a WAN port for forwarding traffic of a source IP address according to actual needs.

## E-bank data based on source in&out





When this function is enabled, the transmitting port and receiving port of E-bank traffic must be consistent, and this configuration is not affected by the load balancing policy. When this function is disabled, some E-banks cannot be used normally.

By default, the router's multi-WAN policy is **Intelligent Load Balancing**. When **Customize** is selected, the page is as follows. You can click **Add** to customize the multi-WAN policy.



### Parameter description

Parameter	Description
<b>Add</b>	Used to add a new multi-WAN policy.
IP Group	Specifies the IP group of the multi-WAN policy. Data traffic from this IP group which can only be forwarded through the specified WAN port. Only one rule can be configured for an IP group. You can configure the IP group in <a href="#">IP Group</a> .
WAN Port	Specifies the WAN port of the multi-WAN policy. Data traffic from the specified IP group will only be forwarded through this WAN port.
Remark	Specifies the introduction of the multi-WAN policy.
Status	Specifies the status of the customized multi-WAN policy, including <b>Enabled</b> and <b>Disabled</b> .

Parameter	Description
	Used to edit, enable, disable or delete the multi-WAN policy.
Operation	 <b>Edit</b> : Used to modify the multi-WAN policy.
	 <b>Enable</b> : Used to enable the multi-WAN policy.
	 <b>Disable</b> : Used to disable the multi-WAN policy.
	 <b>Delete</b> : Used to delete the multi-WAN policy.

## Example of configuring multi-WAN policy

### Networking requirements

An enterprise uses the enterprise router to set up a network. To meet the requirements of the enterprise network, two broadband lines have been handled and the internet has been successfully accessed.

To achieve load balancing, the enterprise has the following requirements:

- Computers with IP addresses 192.168.0.2 - 192.168.0.100 access the internet through Broadband A.
- Computers with IP addresses 192.168.0.101 - 192.168.0.250 access the internet through Broadband B.

### Solution

You can use the multi-WAN policy function of the router to meet the requirements.

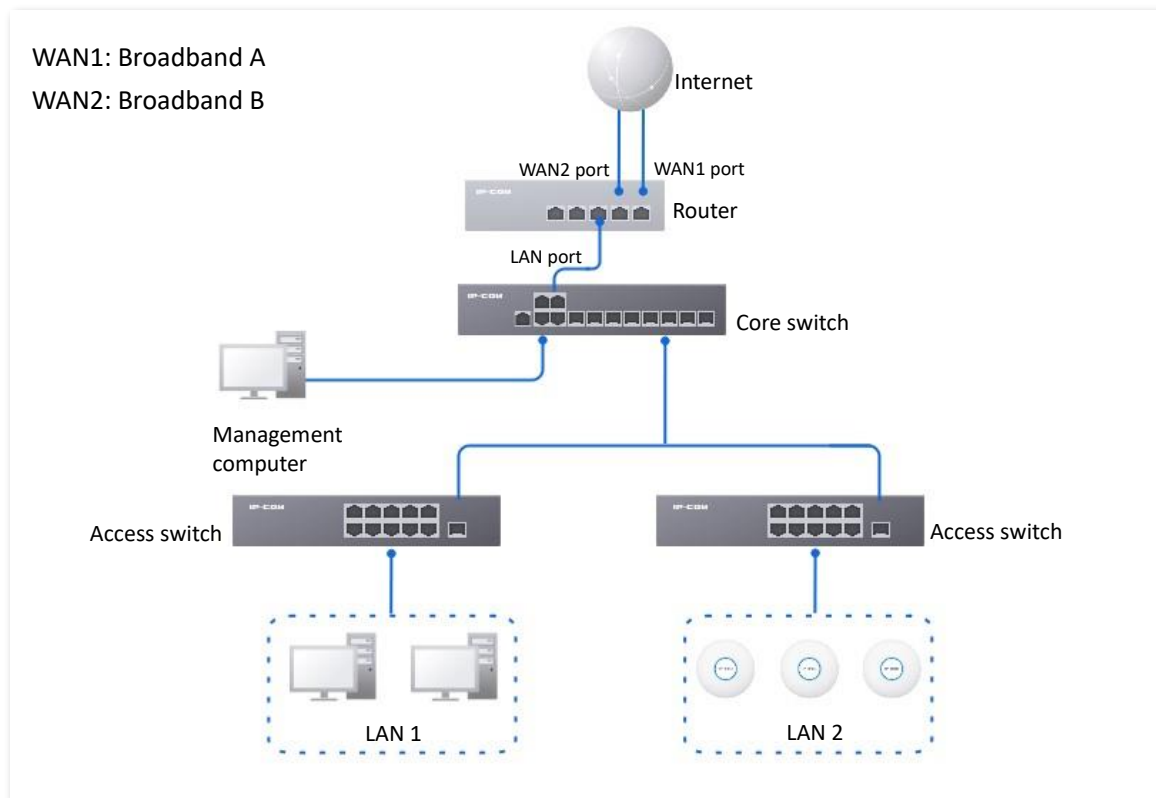

### Configuration procedure

Configure the IP group

Enable the multi-WAN policy function

Customize the multi-WAN policy

1. [Log in to the web UI of the router.](#)
2. Configure the IP group.

Navigate to **Audit > Group Policy > IP Group**, and click **Add** to configure the following two IP groups.

Policy Name	IP Address Range	Remark	Operation
IP Group 1	192.168.0.2~192.168.0.100	-	<a href="#">Edit</a> <a href="#">Delete</a>
IP Group 2	192.168.0.101~192.168.0.250	-	<a href="#">Edit</a> <a href="#">Delete</a>

3. Enable the multi-WAN policy function.
  - 1) Navigate to **More > Advanced Routing > Multi-WAN Policy**.
  - 2) Select **Customize** for **Multi-WAN Policy**.
  - 3) Confirm the prompt information, and click **OK**.



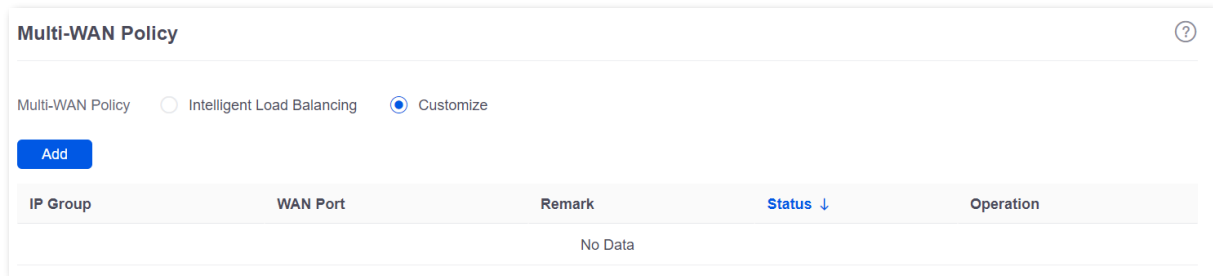

#### 4. Customize the multi-WAN policy.

Navigate to **More > Advanced Routing > Multi-WAN Policy**, and click **Add** to configure the following two multi-WAN policies.

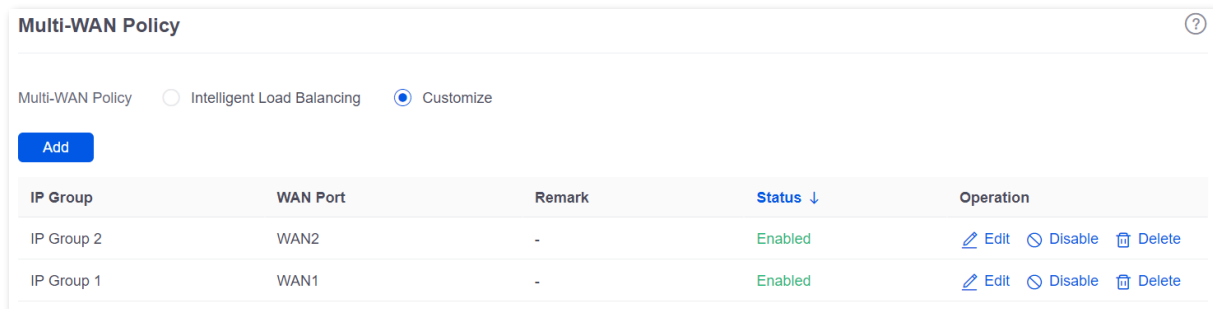

----End

### Verification

When a device in the LAN with an IP address in the range of 192.168.0.2 - 192.168.0.100 accesses the internet, the data traffic is forwarded by the WAN1 port. When a device in the LAN with an IP address in the range of 192.168.0.101 - 192.168.0.250 accesses the internet, the data traffic is forwarded by the WAN2 port.

## 10.1.3 Static routing

### Overview

Routing is an operation to choose an optimum path to convey data from the source address to the target address. A static route is a manually configured special route and is simpler, more efficient, and more reliable. An appropriate static route can reduce issues arising from route selection and ease the overflow of route selection data flow, improving the rate of data packet forwarding.

You can specify a static route by setting **Target Network**, **Subnet Mask**, **Default Gateway** and **Interface**. Among these parameters, **Target Network** and **Subnet Mask** are used to specify a target network or host. After the static route is configured successfully, all the data whose target address is in the target network of the static routing is directly forwarded to the gateway address through the interface of the static route.



- If static routes are completely used in a large-scale and complicated network, route unavailability and network interruption may occur in case of network fault or topology change. Under such circumstances, the network administrator needs to manually change the static routing configurations.
- When a static routing policy conflicts with a customized multi-WAN policy, static routing takes precedence.



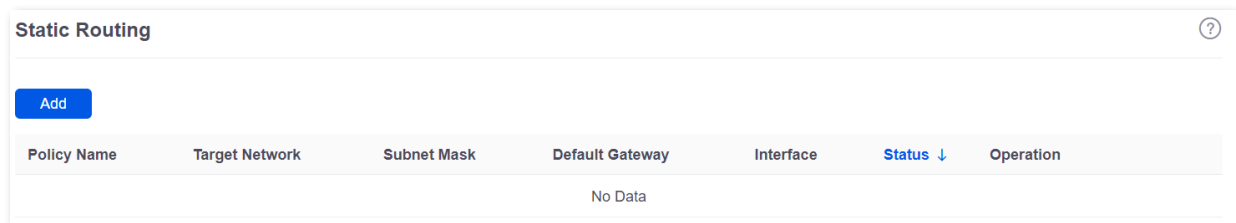

[Log in to the web UI of the router](#), and navigate to **More > Advanced Routing > Static Routing** to enter the page. On this page, you can configure the corresponding static routing according to actual network conditions. You can click to select parameters to be displayed.



You can click **Add** to add a new static routing policy.

### Parameter description

Parameter	Description
Policy Name	Specifies the name of the static routing policy.
Target Network	Specifies the IP address of the target network. <b>0.0.0.0</b> target network and <b>0.0.0.0</b> subnet mask indicate the default route. Tip If no accurate route is found in the route table, the default route will be chosen for router to forward data packets.

Parameter	Description
Subnet Mask	Specifies the subnet mask of the target network.
Default Gateway	Specifies the ingress port IP address of the next hop route after data packets egress from the router. <b>0.0.0.0</b> indicates direct routing, which means that the target network is directly connected to the interface of the router.
Interface	Specifies the interface from which packets egress. Select it as required.
Status	Specifies the current policy status, including <b>Enabled</b> and <b>Disabled</b> .
Operation	Used to edit, enable, disable or delete the static routing policy.  <b>Edit</b> : Used to modify the static routing policy.  <b>Enable</b> : Used to enable the static routing policy.  <b>Disable</b> : Used to disable the static routing policy.  <b>Delete</b> : Used to delete the static routing policy.

## Example of configuring static routing

### Networking requirements

An enterprise uses the enterprise router to set up a network. The WAN1 port is connected to the internet through PPPoE. Now the enterprise has set up an intranet, which is in a different network from the internet. The WAN2 port is connected to the enterprise's intranet through dynamic IP address.

The enterprise has the following requirements: LAN users can access both the internet and the intranet.

### Solution

You can use the Static Routing function to meet the requirements.

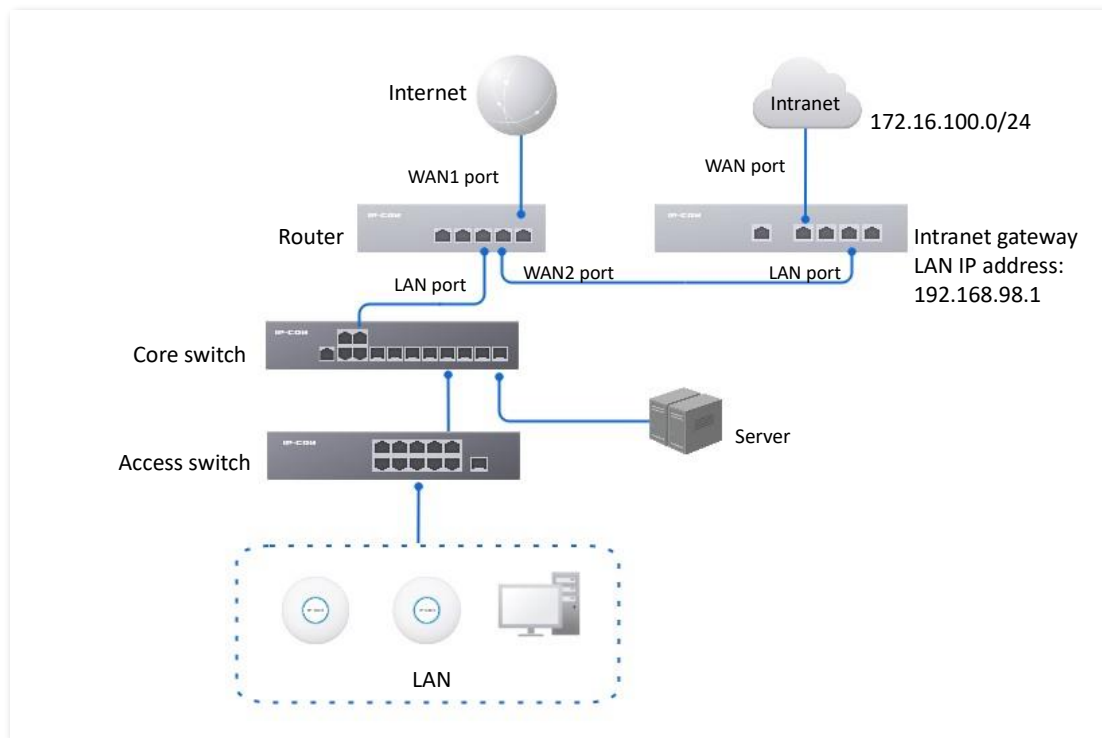

### Configuration procedure

Connect the WAN port to the internet

Configure the static routing

1. [Log in to the web UI of the router.](#)
2. Enable two WAN ports and connect WAN2 port to the internet.
  - 1) Navigate to **Network > Internet Settings**.
  - 2) Set **No. of WAN Ports** to **2**.

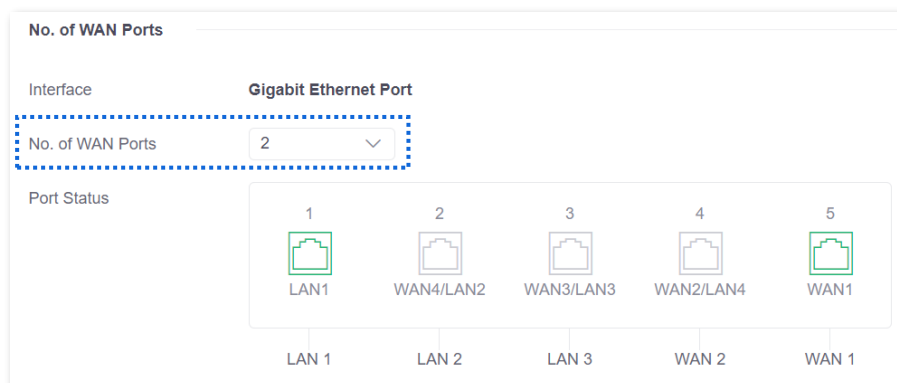

- 3) Under **WAN2**, select **Dynamic IP Address** for **Connection Type**, and click **Connect**.

When the **Status** is **Connected**, the WAN2 port is successfully connected to the network.

3. Configure the static routing.

1) Obtain the IP address information of the WAN2 port.

Navigate to **Network > Internet Settings**, and view the IP address information obtained by WAN2 under **Connection Status**, assuming the following:

WAN2 IP Address	Subnet Mask	Default Gateway	Primary DNS
192.168.98.190	255.255.255.0	192.168.98.1	192.168.98.1

2) Configure parameters of the static routing.

The following table lists the static routing parameters for example:

Policy Name	Target Network	Subnet Mask	Default Gateway	Interface
Intranet Access	172.16.100.0	255.255.255.0	192.168.98.1	WAN2

Navigate to **More > Advanced Routing > Static Routing**, click **Add** to configure parameters in the **Add Static Routing** window, and click **Save**.

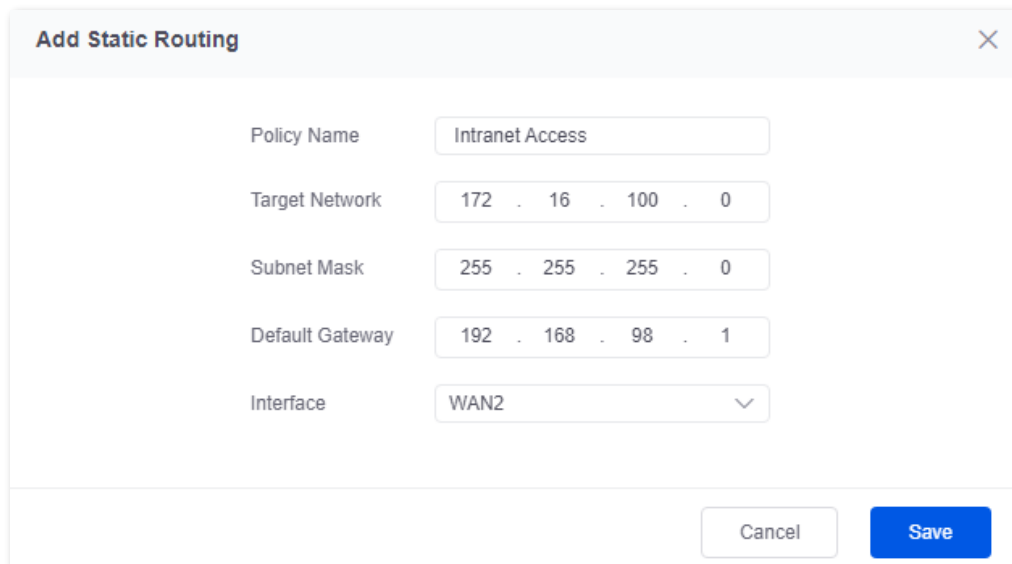

The 'Add Static Routing' dialog box contains the following fields:

- Policy Name: Intranet Access
- Target Network: 172 . 16 . 100 . 0
- Subnet Mask: 255 . 255 . 255 . 0
- Default Gateway: 192 . 168 . 98 . 1
- Interface: WAN2

Buttons: Cancel, Save

----End

The static route is added successfully.

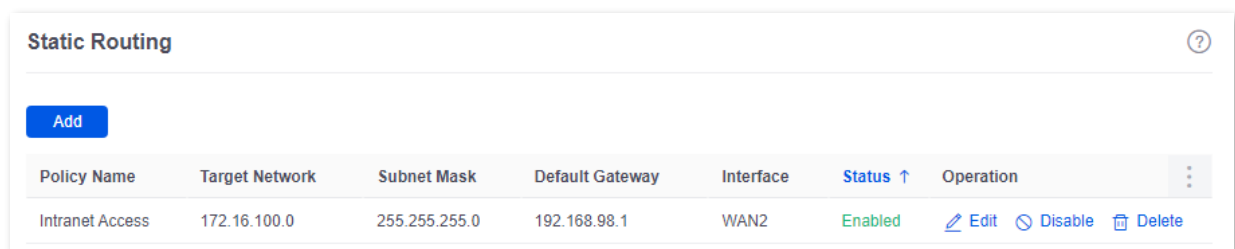

Policy Name	Target Network	Subnet Mask	Default Gateway	Interface	Status ↑	Operation
Intranet Access	172.16.100.0	255.255.255.0	192.168.98.1	WAN2	Enabled	<a href="#">Edit</a> <a href="#">Disable</a> <a href="#">Delete</a>

## Verification

LAN users can access both the internet and the intranet.

## 10.1.4 Routing table

[Log in to the web UI of the router](#), and navigate to **More > Advanced Routing > Routing Table** to enter the page. On this page, you can view the detailed routing information of the router.

Target Network	Subnet Mask	Default Gateway	Interface
0.0.0.0	0.0.0.0	172.16.200.1	WAN1
10.10.96.0	255.255.224.0	0.0.0.0	LAN
172.16.200.1	255.255.255.255	0.0.0.0	WAN1
192.168.0.0	255.255.255.0	0.0.0.0	LAN

### Parameter description

Parameter	Description
Target Network	<p>Specifies the IP address of the destination network. If both the destination network and subnet mask are 0.0.0.0, it is the default route.</p> <p> <b>Note</b></p> <p>When a route that exactly matches the destination address of the packet cannot be found in the routing table, the router will select the default route to forward the packet.</p>
Subnet Mask	<p>Specifies the subnet mask of the destination network.</p>
Default Gateway	<p>Specifies the ingress IP address of the next hop router of data packets. The default gateway is 0.0.0.0, which means direct routing, that is, the destination network is the network directly connected to the interface of the router.</p>
Interface	<p>Specifies the interface of the router that data packets are forwarded.</p>

## 10.1.5 Policy routing

### Overview

Policy routing, also known as policy-based routing, means that the next hop forwarding address of an IP packet is determined by a comprehensive consideration of multiple factors, rather than the destination or source IP address. You can set the source network, target network, destination port, protocol and WAN port with the policy routing for more accurate route selection.

With this function enabled, the router will forward the data packets that meet the policy conditions to the specified target network through the specified WAN port.



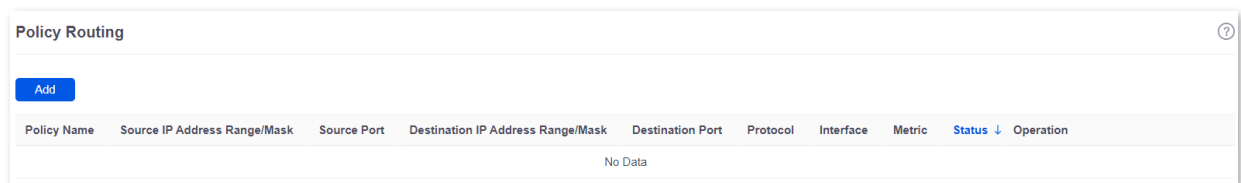

[Log in to the web UI of the router](#), and navigate to **More > Advanced Routing > Policy Routing** to enter the page. On this page, you can configure the policy routing according to your needs.



You can click **Add** to add a new policy routing policy.



## Parameter description

Parameter	Description
Policy Name	Specifies the name of the policy routing rule.
Source IP Address Range/Mask	Specifies the source IP address range of data packets.
Source Port	Specifies the source port of data packets.
Destination IP Address Range/Mask	Specifies the destination IP address range to which data packets are forwarded.
Destination Port	Specifies the port of the device to which data packets are forwarded, which ranges from 1 to 65535.
Protocol	<p>Specifies the protocol type of data packets.</p> <ul style="list-style-type: none"><li>- <b>ALL</b>: If you are not sure about the protocol type, <b>ALL</b> is recommended.</li><li>- <b>TCP</b>: Transmission Control Protocol is a common protocol that provides reliable data transmission.</li><li>- <b>UDP</b>: User Datagram Protocol is a simple packet-oriented communication protocol.</li></ul>
Interface	Specifies the physical port for which the policy takes effect. Data packets that meet the conditions of the policy routing will be forwarded through this port.
Metric	Specifies the metric of the policy. A smaller metric indicates a higher priority for policy routing. The metric value ranges from 1 to 9999.
Status	Specifies the status of the policy routing rule, including <b>Enabled</b> , <b>Disabled</b> and <b>Expired</b> .
Operation	<p>Used to edit, enable, disable or delete the policy routing policy.</p> <ul style="list-style-type: none"><li> <b>Edit</b>: Used to modify the corresponding policy routing policy.</li><li> <b>Enable</b>: Used to enable the corresponding policy routing policy.</li><li> <b>Disable</b>: Used to disable the corresponding policy routing policy.</li><li> <b>Delete</b>: Used to delete the corresponding policy routing policy.</li></ul>

## Example of configuring policy routing

### Networking requirements

An enterprise uses the enterprise router to set up a network. The router is connected to the internet through PPPoE. The enterprise has built a web server on the intranet, which is in a

different network from the internet. The access mode of the enterprise's intranet is dynamic IP address.

The enterprise has the following requirements: Users whose LAN addresses are 192.168.0.2 - 192.168.0.254 can access both the internet and the web server of the enterprise's intranet (the port number is 9999).

## Solution

You can use the Policy Routing function to meet the requirements.

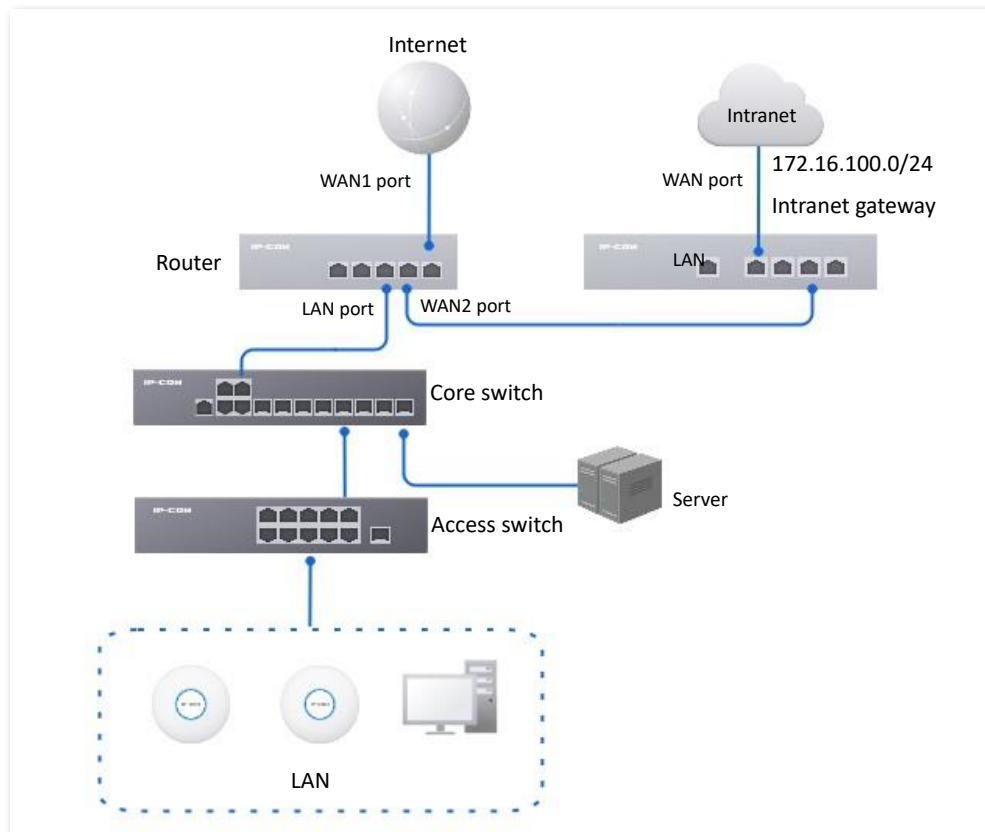

## Configuration procedure

Configure the WAN2 port to access the internet

Configure the policy routing

1. [Log in to the web UI of the router.](#)
2. Configure the WAN2 port to access the internet.
  - 1) Navigate to **Network > Internet Settings**.
  - 2) Set **No. of WAN Ports** to **2**.

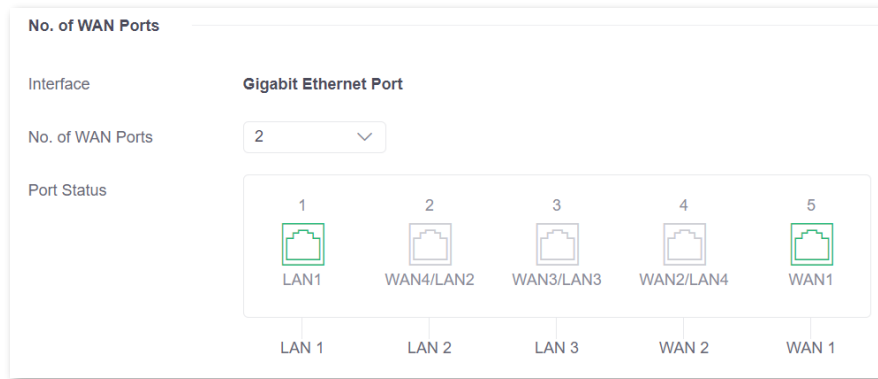

3) Under **WAN2**, select **Dynamic IP Address** for **Connection Type**, and click **Connect**.

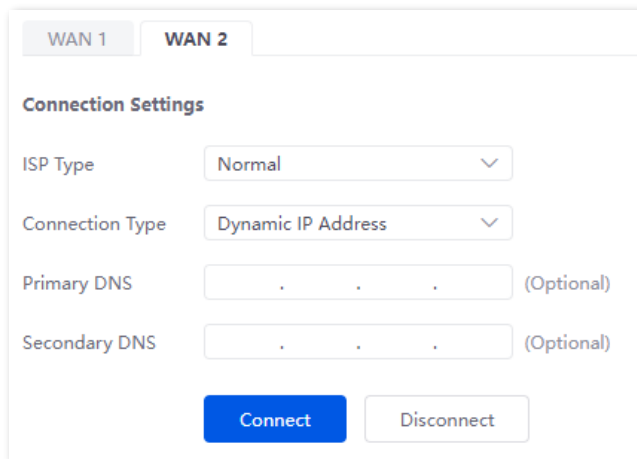

When the **Status** is **Connected**, the WAN port is successfully connected to the network.

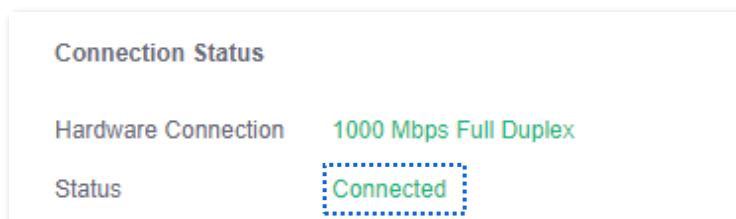

3. Configure the policy routing.

The following table provides examples of policy routing parameters.

Policy Name	Source IP Address Range/Mask	Source Port	Destination IP Address Range/Mask	Destination Port	Protocol	Interface	Metric
Web Server Access	192.168.0.0/24	1-65535	172.16.100.0/24	1-65535	ALL	WAN2	10

Navigate to **More > Advanced Routing > Policy Routing**, click **Add** to configure parameters in the **Add Policy Routing** window, and click **Save**.

**Add Policy Routing**

Policy Name: Web Server Access

Source IP Address Range/Mask: 192.168.0.0 / 24

Source Port: 1 - 65535

Destination IP Address Range/Mask: 172.16.100.0 / 24

Destination Port: 1 - 65535

Protocol: ALL

Interface: WAN2

Metric: 10

Buttons: Cancel, Save

----End

The policy routing is added successfully.

Policy Name	Source IP Address Range/Mask	Source Port	Destination IP Address Range/Mask	Destination Port	Protocol	Interface	Metric	Status	Operation
Web Server Access	192.168.0.0/24	1-65535	172.16.100.0/24	1-65535	ALL	WAN2	10	Enabled	Edit Disable Delete

## Verification

Users whose LAN addresses ranging from 192.168.0.2 - 192.168.0.254 can access both the internet and the intranet.

## 10.2 Virtual service

### 10.2.1 DMZ

#### Overview

After a device in the LAN is set as the DMZ host, the device enjoys no limitations when communicating with the internet. For example, if video meetings or online games are underway on a computer, you can set that computer as the DMZ host to make the video meeting and online games go smoother.



- After you set a LAN device as a DMZ host, the device will be completely exposed to the internet and the firewall of the router does not take effect on the device.
- Hackers may attack the local network by using the DMZ host. Exercise caution to using the DMZ function.
- The security guard, anti-virus software and system firewall on the DMZ host may affect the DMZ function. Disable them when using this function. When you are not using the DMZ function, you are recommended to disable the function and enable the firewall, security guard and anti-virus software on the DMZ host.

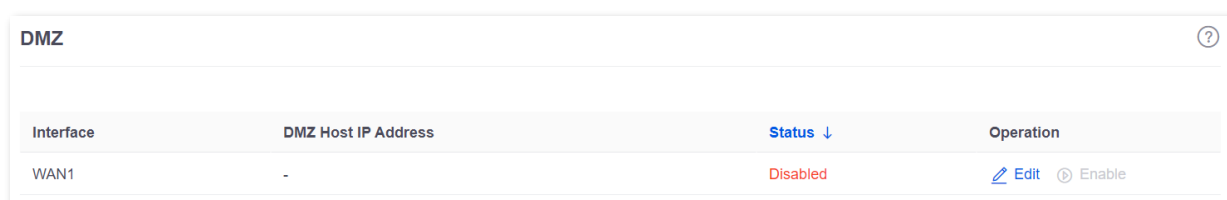

[Log in to the web UI of the router](#), and navigate to **More > Virtual Service > DMZ** to enter the page. On this page, you can modify the corresponding DMZ policy according to your needs. The DMZ function is disabled by default. You can click  to select parameters to be displayed.



Interface	DMZ Host IP Address	Status ↓	Operation
WAN1	-	Disabled	<a href="#">Edit</a> <a href="#">Enable</a>

#### Parameter description

Parameter	Description
Interface	Specifies the port whose DMZ service will be enabled. The default port is <b>WAN1</b> .
DMZ Host IP Address	Specifies the IP address of the device to be set as a DMZ host within the LAN.
Status	Specifies the status of the DMZ policy, including <b>Enabled</b> and <b>Disabled</b> .

Parameter	Description
Operation	Used to edit, enable or disable the DMZ policy.  <b>Edit</b> : Used to modify the DMZ policy.  <b>Enable</b> : Used to enable the DMZ policy.  <b>Disable</b> : Used to disable the DMZ policy.

## Example of configuring DMZ

### Networking requirements

An enterprise uses the enterprise router to set up a network. The router has connected to the internet and can offer internet service for LAN users. The enterprise has the following requirements:

The intranet web server is open to internet users to enable staff to access the intranet even when they are not in the enterprise.

### Solution

- You can use the DMZ function to enable internet users to access the intranet web server.
- You can use the DHCP Reservation function to avoid access failures caused by web server address changes.

Assume that the information on the web server is shown below:

- IP address of the web server: 192.168.0.250
- MAC address of the host that runs the web server: C8:9C:DC:60:54:69
- Service port: 9999



### Tip

- Before the configuration, ensure that the WAN port of the router obtains a public IP address. If the WAN port obtains a private IP address or an intranet IP address assigned by the ISP, the DMZ function may not take effect. Common IPv4 addresses are classified into class A, class B and class C. Private IP addresses of class A range from 10.0.0.0 to 10.255.255.255. Private IP addresses of class B range from 172.16.0.0 to 172.31.255.255. Private IP addresses of class C range from 192.168.0.0 to 192.168.255.255.
- ISPs may not support unreported web service accessed using the default port number 80. Therefore, when setting DMZ host, you are recommended to set the external port as a non-familiar port (1024 to 65535), such as 9999, to ensure normal access.

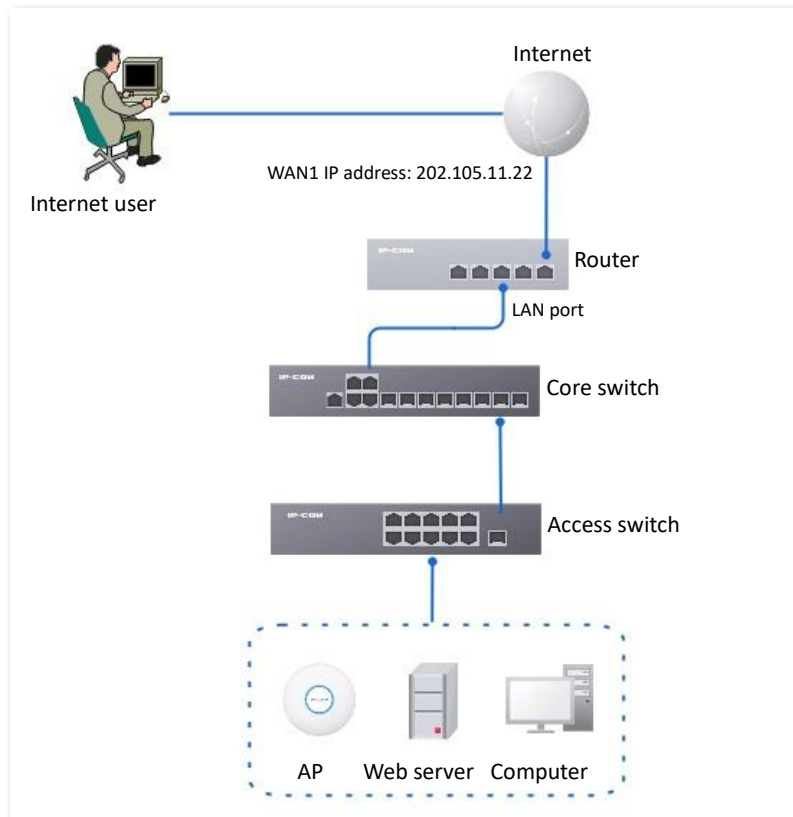

## Configuration procedure

Set the DMZ host

Reserve a fixed IP address for the DMZ host

1. [Log in to the web UI of the router.](#)
2. Set the DMZ host.
  - 1) Navigate to **More > Virtual Service > DMZ.**
  - 2) Locate the corresponding WAN port, and click **Edit.**

DMZ <span style="float: right;">?</span>			
Interface	DMZ Host IP Address	Status ↓	Operation
WAN1	-	Disabled	<a href="#">Edit</a> <a href="#">Enable</a>

- 3) Set **DMZ Host IP Address** (the IP address of the LAN device to be set as the DMZ host), which is **192.168.0.250** in this example.
- 4) Click **Save.**

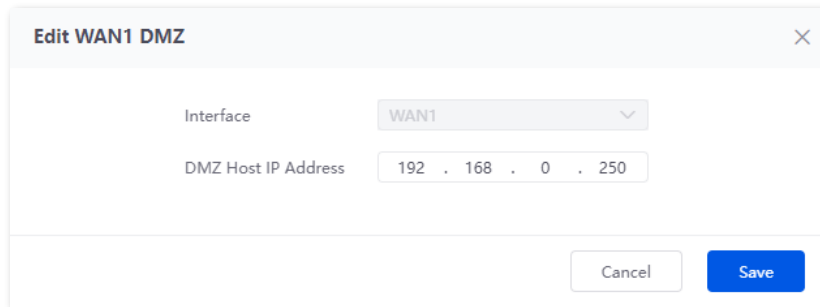

5) Click **Enable**.

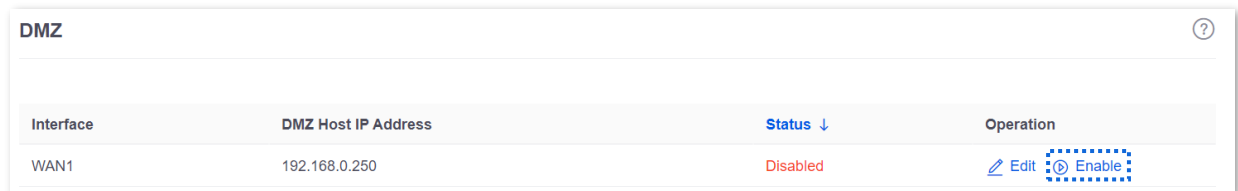

Interface	DMZ Host IP Address	Status ↓	Operation
WAN1	192.168.0.250	Disabled	<a href="#">Edit</a> <a href="#">Enable</a>

3. Reserve a fixed IP address for the DMZ host.

1) Navigate to **Network > DHCP Settings > DHCP Reservation**, and click **Add**.

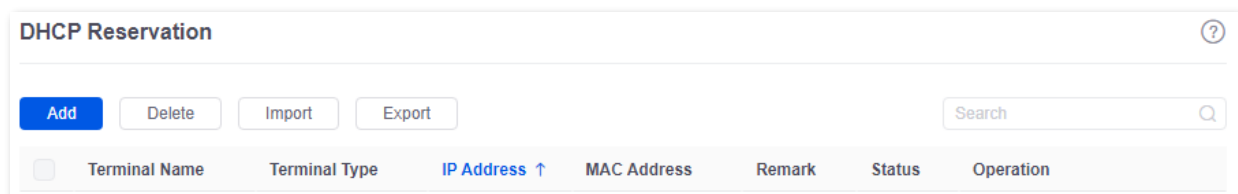

<input type="checkbox"/>	Terminal Name	Terminal Type	IP Address ↑	MAC Address	Remark	Status	Operation
--------------------------	---------------	---------------	--------------	-------------	--------	--------	-----------

2) Set the following rules, and click **Save**.

- Set **Terminal Name**, which is **Web Server** in this example.
- Set **IP Address** to the fixed IP address assigned to the server host, which is **192.168.0.250** in this example.
- Set **MAC Address** of the server host, which is **C8:9C:DC:60:54:69** in this example.
- Set **Remark**, which is **Web Server Address** in this example.

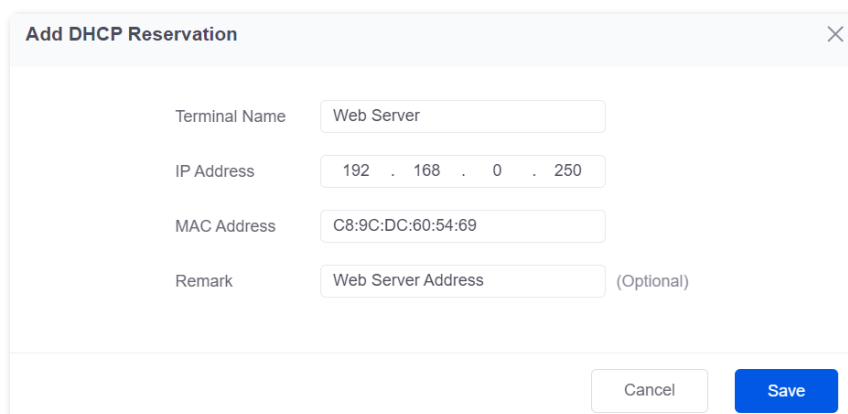

----End



## Verification

Internet users can successfully access the intranet server by using the **Intranet service application layer protocol name://WAN port IP address**. If the intranet service port is not the default port number, the access address is **Intranet service application layer protocol name://WAN port IP address:Intranet service port**.

In this example, the access address is **http://202.105.11.22:9999**.

You can find the router's current WAN port IP address in [Connection Status](#).

If [DDNS](#) is enabled on the WAN port, internet users can also access the intranet server by using **Intranet service application layer protocol name://WAN port domain name: Intranet service port**.

## 10.2.2 DDNS

### Overview

DDNS is abbreviated for Dynamic Domain Name Service. When a service is running, the DDNS client sends the IP address of the current WAN port of the router to the DDNS server, and the server updates the mapping relationships between the domain name and IP address in the database, achieving dynamic domain name resolution.

On this page, you can map the dynamic WAN IP address of the router (public IP address) to a fixed domain name. The DDNS function is generally used with such functions as port mapping and DMZ host to enable internet users to access the LAN server or the web UI of the router through a domain name without caring about the change of the WAN IP address.

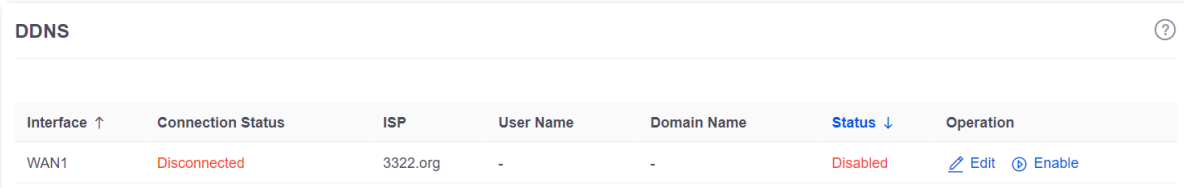

[Log in to the web UI of the router](#), and navigate to **More > Virtual Service > DDNS** to enter the page. The router has created a corresponding DMZ policy for each WAN port by default, and the status is **Disabled**. On this page, you can modify the DDNS policies according to your needs. The DDNS function is disabled by default. You can click  to select parameters to be displayed.



Interface ↑	Connection Status	ISP	User Name	Domain Name	Status ↓	Operation
WAN1	Disconnected	3322.org	-	-	Disabled	<a href="#">Edit</a> <a href="#">Enable</a>

### Parameter description

Parameter	Description
Interface	Specifies the port for which the DDNS service is enabled.
Connection Status	Specifies the connection status between the router and the domain server.
ISP	Specifies the service provider of DDNS.  <b>Note</b> You need to sign up at the website of the ISP for an account before configuring the DDNS service.
User Name	Specifies the user name for logging in to the DDNS service. The user name is the login user name that you have signed up at the website of the ISP.
Domain Name	Specifies the domain name information provided by the DDNS service provider. Except for <b>oray.com</b> , you have to manually enter the domain name that you have applied at the corresponding website when you use services from other service providers.

Parameter	Description
Status	Specifies the status of the DDNS service policy, including <b>Enabled</b> , <b>Disabled</b> and <b>Expired</b> .
Operation	Used to edit, enable or disable the DDNS service policy.  <b>Edit</b> : Used to modify the DDNS service policy.  <b>Enable</b> : Used to enable the DDNS service policy.  <b>Disable</b> : Used to disable the DDNS service policy.

## Example of configuring DDNS

### Networking requirements

An enterprise uses the enterprise router to set up a network. The router is connected to the internet and can offer internet service for LAN users. The enterprise has the following requirements:

The intranet web server is open to internet users to enable staff to access the intranet even when they are not in the enterprise.

### Solution

- You can use the Port Mapping function to enable internet users to access the intranet web server.
- You can use the DDNS function to enable internet users to access the intranet web server through a fixed domain name, avoiding access failures caused by WAN IP address change.
- You can use the DHCP Reservation function to avoid access failures caused by web server address changes.

Assume that the information on the web server is shown below:

- IP address of the web server: 192.168.0.250
- MAC address of the host that runs the web server: C8:9C:DC:60:54:69
- Service port: 9999



- Before the configuration, ensure that the WAN port of the router obtains a public IP address. If the WAN port obtains a private IP address or an intranet IP address assigned by the ISP, the DDNS function may not take effect. Common IPv4 addresses are classified into class A, class B and class C. Private IP addresses of class A range from 10.0.0.0 to 10.255.255.255. Private IP addresses of class B range from 172.16.0.0 to 172.31.255.255. Private IP addresses of class C range from 192.168.0.0 to 192.168.255.255.
- ISPs may not support unreported web service accessed using the default port number 80. Therefore, when setting port mapping, you are recommended to set the external port as a non-familiar port (1024 to 65535), such as 9999, to ensure normal access.
- Internal and external ports can be different.

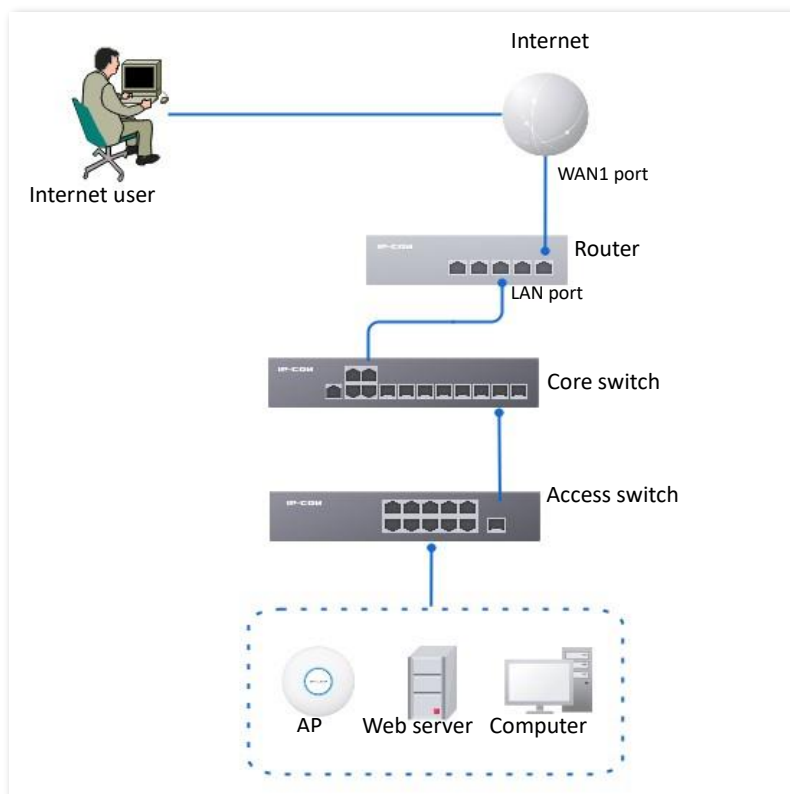

### Configuration procedure

Set port mapping

Set the fixed IP address assigned to the server host

Set DDNS

1. [Log in to the web UI of the router.](#)
2. Set port mapping.

Navigate to **More > Virtual Service > Port Mapping**, and set the following rules. If necessary, you can refer to [Port mapping](#).

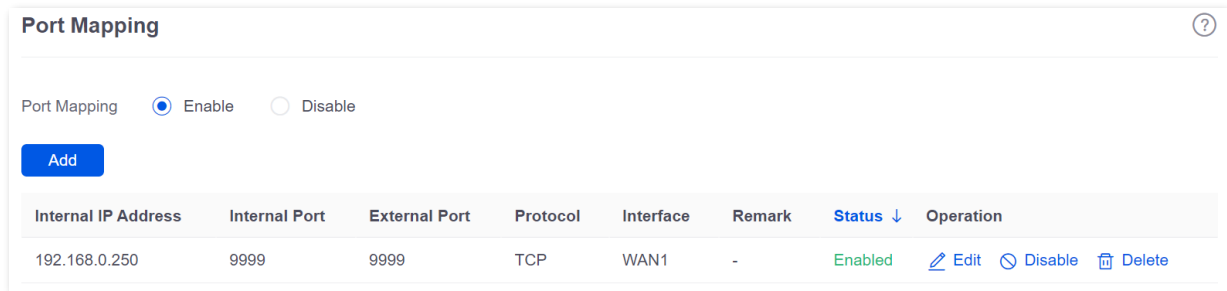

3. Set the fixed IP address assigned to the server host.

- 1) Navigate to **Network > DHCP Settings > DHCP Reservation**, and click **Add**.

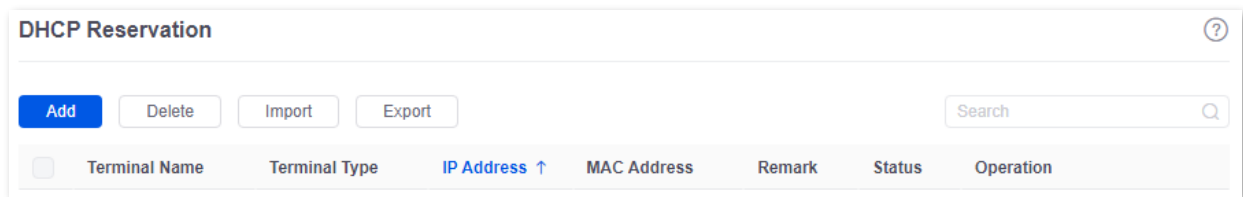

- 2) Set the following rules, and click **Save**.

- Set **Terminal Name**, which is **Web Server** in this example.
- Set **IP Address** to the fixed IP address assigned to the server host, which is **192.168.0.250** in this example.
- Set **MAC Address** of the server host, which is **C8:9C:DC:60:54:69** in this example.
- Set **Remark**, which is **Web Server Address** in this example.

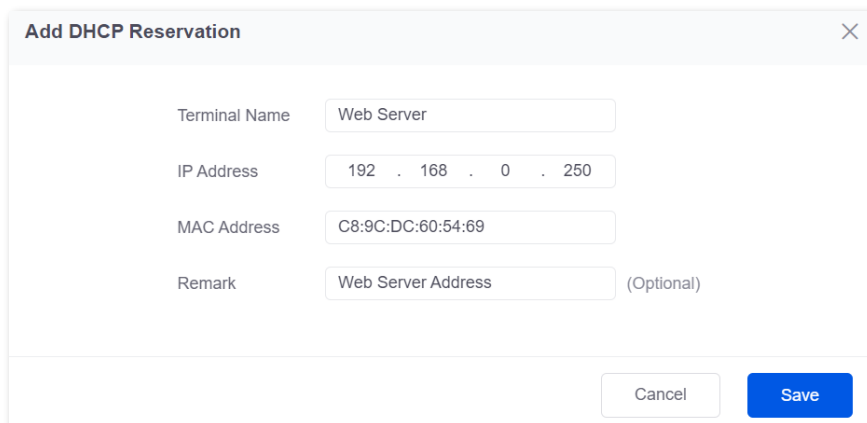

The fixed IP address is reserved successfully. See the following figure.

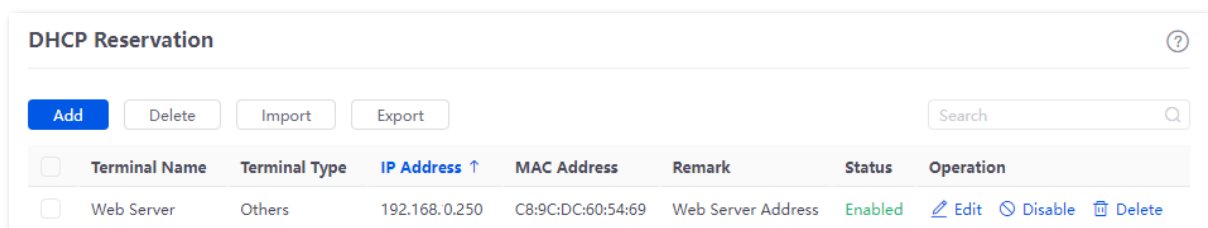

4. Register a domain name.

Log in to the DDNS provider website. Assume that the user name you registered is **JohnDoe**, the password is **JohnDoe123456**, and the domain name is **JohnDoe.3322.org**.

5. Set DDNS.

- 1) Navigate to **More > Virtual Service > DDNS** to enter the configuration page. Click **Edit** after the corresponding WAN port rule, which is **WAN1** in this example.

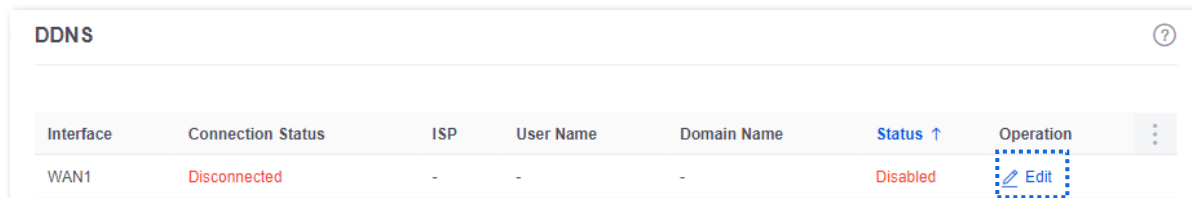

Interface	Connection Status	ISP	User Name	Domain Name	Status ↑	Operation
WAN1	Disconnected	-	-	-	Disabled	<a href="#">Edit</a>

- 2) Configure the following parameters in the pop-up **Edit WAN1 DDNS** window, and then click **Save**.
  - Set **Server Provider** (the DDNS provider where you applied the domain name), which is **3322.org** in this example.
  - Set **User Name** and **Password**, which are **JohnDoe** and **JohnDoe123456** in this example.
  - Set **Domain Name**, which is **JohnDoe.3322.org** in this example.

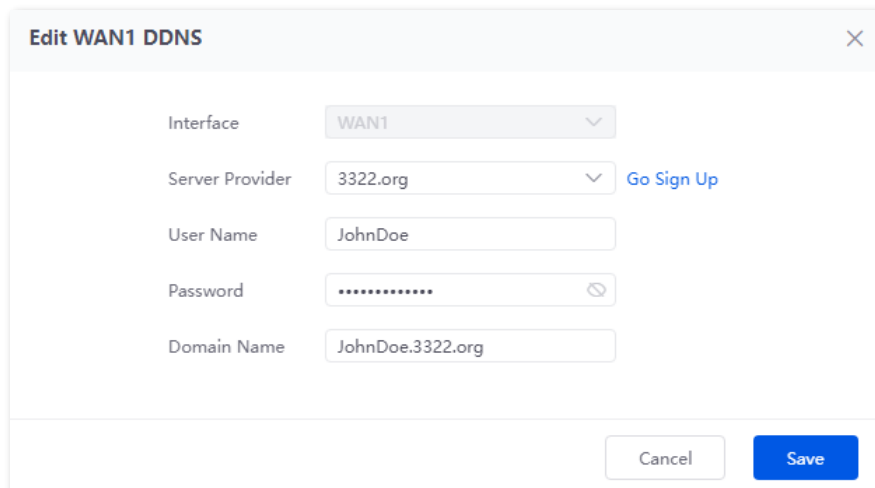

**Edit WAN1 DDNS**

Interface: WAN1

Server Provider: 3322.org [Go Sign Up](#)

User Name: JohnDoe

Password: .....

Domain Name: JohnDoe.3322.org

[Cancel](#) [Save](#)

- 3) Click **Enable**.



Interface	Connection Status	ISP	User Name	Domain Name	Status ↑	Operation
WAN1	Disconnected	3322	JohnDoe	JohnDoe.3322.org	Enabled	<a href="#">Edit</a> <a href="#">Enable</a>

----End

The configuration is finished. Wait a moment, and refresh the page. When the **Connection Status** is **Connected**, the connection is successful.

DDNS							?
Interface	Connection Status	ISP	User Name	Domain Name	Status ↓	Operation	
WAN1	Connected	3322	JohnDoe	JohnDoe.3322.org	Enabled	<a href="#">Edit</a> <a href="#">Disable</a>	

## Verification

Internet users can successfully access the intranet server by using the **Intranet service application layer protocol name://WAN port IP address**. If the intranet service port is not the default port number, the access address is **Intranet service application layer protocol name://WAN port IP address:External port**.

In this example, the access address is `http://JohnDoe.3322.org:9999`.



If internet users still cannot access the LAN server after the configuration is completed, try the following methods one by one:

- Ensure that the internal port you entered is correct.
- Maybe the system firewall, anti-virus software and security guard in the LAN server blocked internet user access. Disable these programs and try again.

## 10.2.3 DNS hijacking

### Overview

DNS is abbreviated for Domain Name Server, which is used to manage the relationships between the domain name and the IP address, and map the domain name and the IP address to each other.

After DNS hijacking is configured, when LAN users access the specified domain name, the domain name is directly parsed to the IP address corresponding to the access rule.

[Log in to the web UI of the router](#), and navigate to **More > Virtual Service > DNS Hijacking** to enter the page. On this page, you can configure the DNS hijacking policy as required.

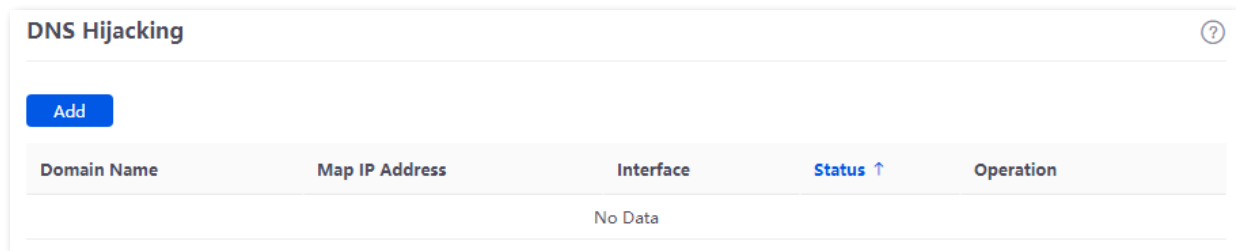

### Parameter description

Parameter	Description
<a href="#">Add</a>	Used to add a new DNS hijacking policy.
Domain Name	Specifies the domain name to be hijacked.
Map IP Address	Specifies the IP address to be accessed after the hijacking.
Interface	Specifies the specified egress of the DNS hijacking policy.
Status	Specifies the current status of the DNS hijacking policy, including <b>Enabled</b> and <b>Disabled</b> .
Operation	Used to edit, enable, disable or delete the DNS hijacking policy. <a href="#">Edit</a> : Used to modify the DNS hijacking policy. <a href="#">Enable</a> : Used to enable the DNS hijacking policy. <a href="#">Disable</a> : Used to disable the DNS hijacking policy. <a href="#">Delete</a> : Used to delete the DNS hijacking policy.

## Example of configuring DNS hijacking

### Networking requirements

An enterprise uses the enterprise router to set up a network. The router has connected to the internet and can offer internet service for LAN users. The enterprise has the following requirements:

When LAN users visit Amazon (Amazon.com), eBay (eBay.com) and other websites, they can access the web UI of the router.

### Solution

The above requirements can be achieved using the DNS hijacking function of the router. Assume that the IP address of the router is 192.168.0.252.



## Configuration procedure

1. [Log in to the web UI of the router.](#)
2. Navigate to **More > Virtual Service > DNS Hijacking**, and click **Add**.
3. Set the following rules of the DNS hijacking policy, and click **Save**.
  - Set **Domain Name** of Amazon, which is **Amazon.com** in this example.
  - Set **Map IP Address** of the router, which is **192.168.0.252** in this example.

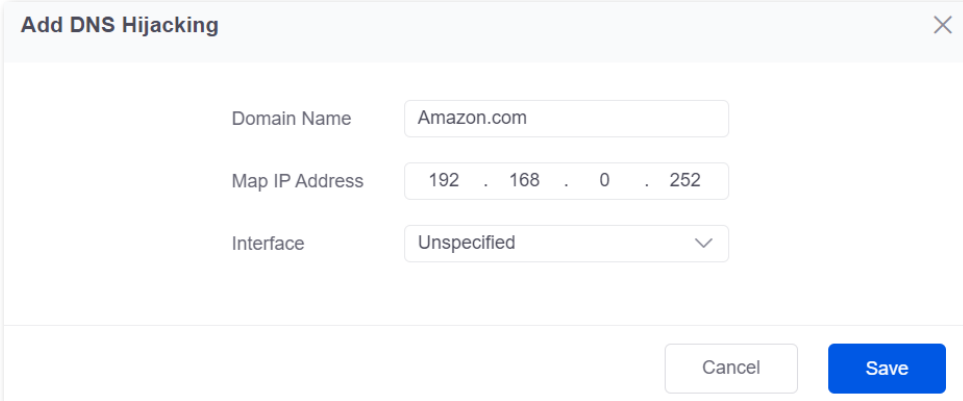

The screenshot shows a dialog box titled "Add DNS Hijacking" with a close button (X) in the top right corner. It contains three input fields: "Domain Name" with the value "Amazon.com", "Map IP Address" with the value "192 . 168 . 0 . 252", and "Interface" with a dropdown menu showing "Unspecified". At the bottom right, there are two buttons: "Cancel" and "Save".

4. Refer to steps 2 to 3 to add a DNS hijacking policy whose domain name is eBay (eBay.com).

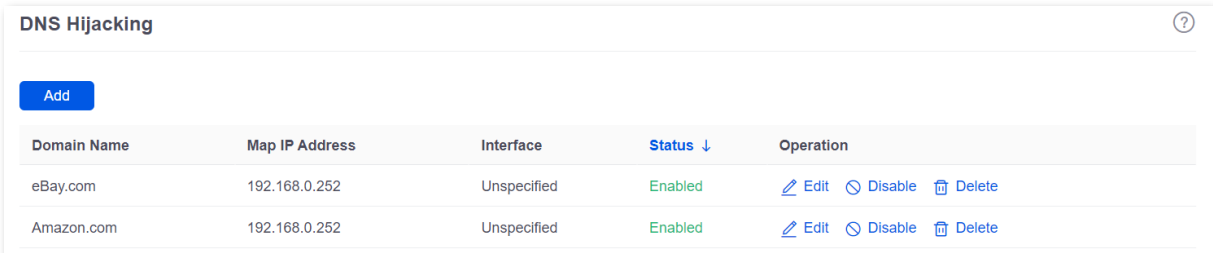

The screenshot shows the "DNS Hijacking" configuration page. It has a title "DNS Hijacking" and a help icon (?). Below the title is an "Add" button. The main content is a table with the following data:

Domain Name	Map IP Address	Interface	Status ↓	Operation
eBay.com	192.168.0.252	Unspecified	Enabled	<a href="#">Edit</a> <a href="#">Disable</a> <a href="#">Delete</a>
Amazon.com	192.168.0.252	Unspecified	Enabled	<a href="#">Edit</a> <a href="#">Disable</a> <a href="#">Delete</a>

----End

## Verification

When LAN users visit Amazon (Amazon.com) and eBay (eBay.com) websites, they always visit the web UI of the router.

## 10.2.4 IP hijacking

### Overview

After IP hijacking is configured, when a LAN user accesses the specified IP address and the port, the IP address will be directly hijacked to the port service corresponding to the mapped IP address.





[Log in to the web UI of the router](#), and navigate to **More > Virtual Service > IP Hijacking** to enter the page. On this page, you can configure the IP hijacking policy as required.

Common ports: 443 (HTTPS protocol webpage service), 80 (HTTP protocol webpage service), 21 (FTP service) and so on.

Destination IP Address	Map IP Address	Port	Interface	Status ↑	Operation
1.1.1.1	192.168.10.1	443	Unspecified	Disabled	<a href="#">Edit</a> <a href="#">Enable</a> <a href="#">Delete</a>

### Parameter description

Parameter	Description
<a href="#">Add</a>	Used to add a new IP hijacking policy.
Destination IP Address	Specifies the IP address to which the IP hijacking policy applies.
Map IP Address	Specifies the IP address to be accessed after the hijacking.
Port	Specifies the port to which the IP hijacking policy applies. The IP addresses will be hijacked only when specified ports are accessed.  <b>Tip</b> The value 0 indicates all ports.
Interface	Specifies the specified egress of the IP hijacking policy.
Status	Specifies the current status of the IP hijacking policy including <b>Enabled</b> and <b>Disabled</b> .

Parameter	Description
Operation	<p>Used to edit, enable, disable or delete the IP hijacking policy.</p> <p> <b>Edit</b>: Used to modify the IP hijacking policy.</p> <p> <b>Enable</b>: Used to enable the IP hijacking policy.</p> <p> <b>Disable</b>: Used to disable the IP hijacking policy.</p> <p> <b>Delete</b>: Used to delete the IP hijacking policy.</p>

## Example of configuring IP hijacking

### Networking requirements

An enterprise uses the enterprise-class router to set up a network. The router is connected to the internet and can offer internet service for LAN users. The enterprise has the following requirements:

The LAN users are redirected to the web UI of the router when accessing 1.1.1.1.

### Solution

You can configure the IP hijacking function to meet the preceding requirements.

Assume that the management IP address of the router is 192.168.0.252 and the port number of the HTTPS web service is 443.

### Configuration procedure

1. [Log in to the web UI of the router.](#)
2. Navigate to **More > Virtual Service > IP Hijacking**, and click **Add**.
3. Configure parameters in the **Add IP Hijacking** window, and click **Save**.
  - Set **Destination IP Address**, which is **1.1.1.1** in this example.
  - Set **Map IP Address**, which is **192.168.0.252** in this example.
  - Set **Port**, which is **443** in this example.

**Add IP Hijacking** [X]

Destination IP Address: 1 . 1 . 1 . 1

Map IP Address: 192 . 168 . 0 . 252

Port: 443 ⓘ

Interface: Unspecified ▾

Cancel Save

----End

### Verification

When LAN users access **1.1.1.1:443**, they access the web UI of the router.

## 10.2.5 UPnP

UPnP is abbreviated for Universal Plug and Play. After the UPnP function is enabled, the router can automatically open the ports for UPnP-supporting programs in the LAN (such as BitComet and AnyChat) and make these applications run smoother.

[Log in to the web UI of the router](#), and navigate to **More > Virtual Service > UPnP** to enter the page. The UPnP function is disabled by default.

After this function is enabled, when UPnP-supporting programs (such as BitComet) are running in the LAN, you can check the port-switching information generated when application programs send requests.

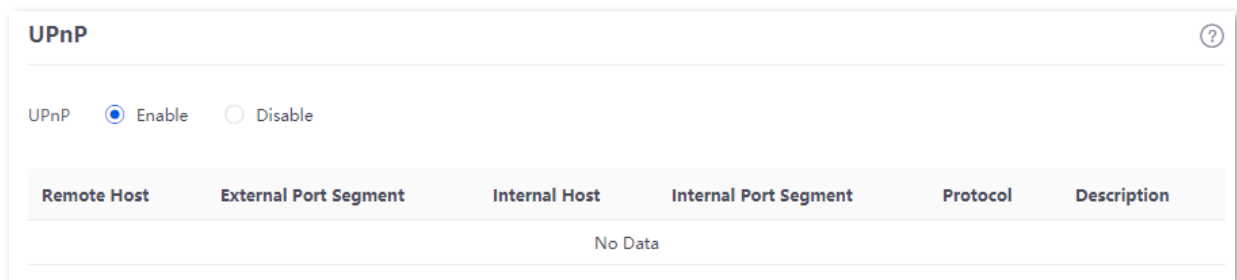

### Parameter description

Parameter	Description
Remote Host	Specifies the IP address of the remote server.
External Port Segment	Specifies the ports used by the remote server.
Internal Host	Specifies the server IP address for automatic port mapping of the LAN.
Internal Port Segment	Specifies the service port of the LAN server.
Protocol	Specifies the protocol type used for the service.
Description	Specifies the relevant information of the application.

## 10.2.6 Port mirroring

### Overview

On this page, you can copy the data from one or multiple ports (source ports) to a specified port (destination port) with the Port Mirroring function. Generally, the mirroring port is connected to a data monitoring device for the network administrator to perform real-time traffic monitoring, performance analysis and fault diagnosis.

[Log in to the web UI of the router](#), and navigate to **More > Virtual Service > Port Mirroring** to enter the page. On this page, you can configure the port mirroring according to your needs.

The Port Mirroring function is disabled by default. The following displays the page when the function is enabled.

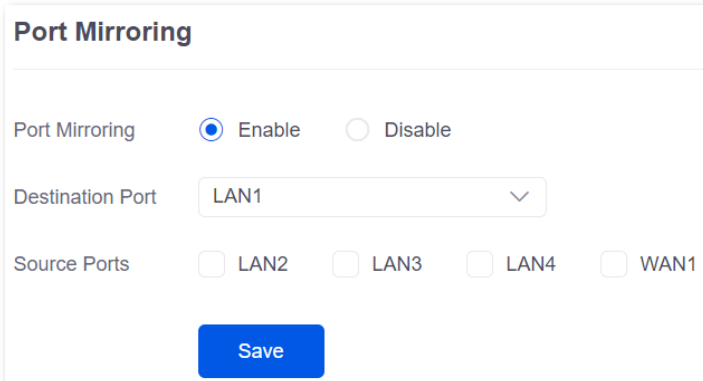

**Port Mirroring**



Port Mirroring  Enable  Disable

Destination Port

Source Ports  LAN2  LAN3  LAN4  WAN1

[Save](#)

### Parameter description

Parameter	Description
Port Mirroring	Used to enable or disable the port mirroring function.
Destination Port	Specifies the destination port, to which the data from the source ports is copied. Generally, the router connected to this port is installed with monitoring firmware.  <a href="#">Note</a> When the Port Mirroring function is enabled, <b>Destination Port</b> can be configured.
Source Ports	Specifies the source port, whose data is copied to the destination port.  <a href="#">Note</a> When the Port Mirroring function is enabled, <b>Source Ports</b> can be configured.

## Example of configuring port mirroring

### Networking requirements

An enterprise uses the enterprise router to set up a network. Recently, the enterprise's network is abnormal and often cannot access the internet. The network administrator needs to capture the data of the router's WAN port and LAN port for analysis.

### Solution

- The above requirements can be achieved using the Port Mirroring function of the router.
- Assume that the monitoring device is connected to the LAN3 port. The device needs to monitor the data of other ports.

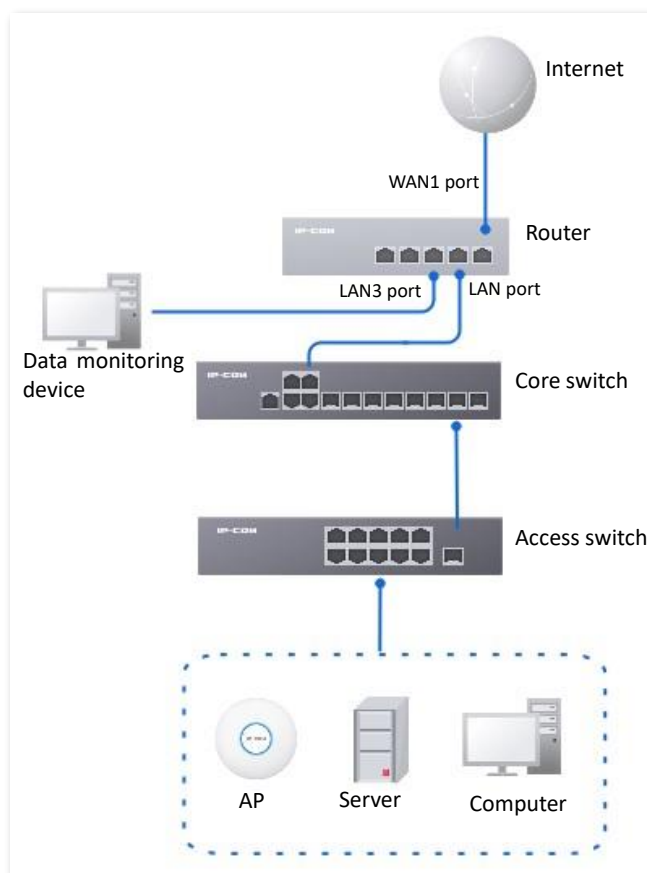

### Configuration procedure

1. [Log in to the web UI of the router.](#)
2. Navigate to **More > Virtual Service > Port Mirroring.**
3. Enable the **Port Mirroring** function.
4. Select **Destination Port**, which is **LAN3** in this example.
5. Select **Source Ports**, which is **LAN1, LAN2, LAN4** and **WAN1** in this example.
6. Click **Save.**

**Port Mirroring**

Port Mirroring  Enable  Disable

Destination Port LAN3

Source Ports  LAN1  LAN2  LAN4  WAN1

**Save**

----End

## Verification

Running monitoring software on the monitoring computer, such as Wireshark, to capture the data packets of the source ports.

## 10.2.7 Port mapping

### Overview

By default, users on the internet cannot access devices on the LAN. The Port Mapping function enables the router to open one or multiple service ports and specify the corresponding LAN server using the IP address and internal port. Therefore, visiting the ports from the internet are mapped to the LAN server. Such a function enables internet users to access the LAN server and prevents the LAN from being attacked.

[Log in to the web UI of the router](#), and navigate to **More > Virtual Service > Port Mapping** to enter the page. On this page, you can configure the port mapping policy according to your needs.

The Port Mapping function is disabled by default. The following displays the page when the function is enabled.

**Port Mapping**





Port Mapping  Enable  Disable

**Add**

Internal IP Address	Internal Port	External Port	Protocol	Interface	Remark	Status ↓	Operation
No Data							



## Parameter description

Parameter	Description
Internal IP Address	Specifies the IP address of the internal server.
Internal Port	Specifies the service port of the LAN host.
External Port	Specifies the port opened by the router for access from internet users.
Protocol	Specifies the protocol type used by the LAN host. If you are not sure about the protocol type of the service, <b>TCP&amp;UDP</b> is recommended.
Interface	Specifies the WAN port used by internet users to access the LAN host.
Remark	Specifies the introduction of the port mapping rule.
Status	Specifies the status of the port mapping policy, including <b>Enabled</b> , <b>Disabled</b> and <b>Expired</b> .
Operation	Used to edit, enable, disable or delete the port mapping policy.  <b>Edit</b> : Used to modify the port mapping policy.  <b>Enable</b> : Used to enable the port mapping policy.  <b>Disable</b> : Used to disable the port mapping policy.  <b>Delete</b> : Used to delete the port mapping policy.

## Example of configuring port mapping

### Networking requirements

An enterprise uses the enterprise router to set up a network. The router has connected to the internet and can offer internet service for LAN users. The enterprise has the following requirements:

The intranet web server is open to internet users to enable staff to access the intranet even when they are not physically in the enterprise.

### Solution

- You can use the Port Mapping function to enable internet users to access the intranet web server. Assume that the external network port opened by the router is 9999.
- You can use the DHCP Reservation function to avoid access failures caused by web server address changes.

Assume that the information on the web server is shown below:

- IP address of the web server: 192.168.0.250

- MAC address of the host that runs the web server: C8:9C:DC:60:54:69
- Service port: 9999



- Before the configuration, ensure that the WAN port of the router obtains a public IP address. If the WAN port obtains a private IP address or an intranet IP address assigned by the ISP, the Port Mapping function may not take effect. Common IPv4 addresses are classified into class A, class B and class C. Private IP addresses of class A range from 10.0.0.0 to 10.255.255.255. Private IP addresses of class B range from 172.16.0.0 to 172.31.255.255. Private IP addresses of class C range from 192.168.0.0 to 192.168.255.255.
- ISPs may not support unreported web service accessed using the default port number 80. Therefore, when setting port mapping, you are recommended to set the external port as a non-familiar port (1024 to 65535), such as 9999, to ensure normal access.
- Internal and external ports can be different.

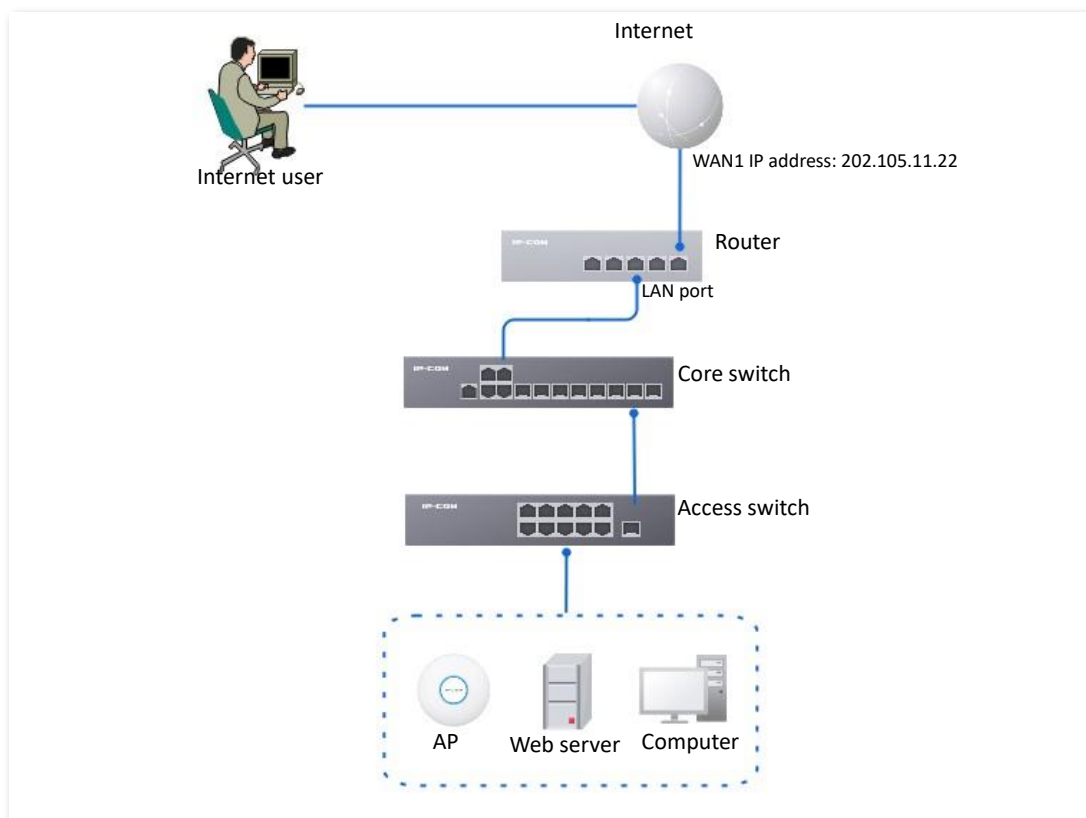

## Configuration procedure

Set port mapping

Set the fixed IP address assigned to the server host

1. [Log in to the web UI of the router.](#)
2. Set port mapping.
  - 1) Navigate to **More > Virtual Service > Port Mapping.**
  - 2) Enable the **Port Mapping** function, and click **Add.**

3) Configure parameters in the **Add** window, and click **Save**.

- Set **Internal IP Address** (the IP address of the web server), which is **192.168.0.250** in this example.
- Set **Intranet Port** (the port used by the web server), which is **9999** in this example.
- Set **External Port** (the port that the router opens to WAN users), which is **9999** in this example.
- Set **Protocol**, which is **TCP** in this example. If you are not sure about the protocol type of the service, **TCP&UDP** is recommended.
- Set **Interface** (the WAN port used by Internet users to access the LAN server), which is **WAN1** in this example.

The screenshot shows a dialog box titled "Add Port Mapping" with a close button (X) in the top right corner. It contains several input fields: "Internal IP Address" with the value "192 . 168 . 0 . 250", "Internal Port" with "9999" and a help icon (i), "External Port" with "9999", "Protocol" with a dropdown menu showing "TCP", "Interface" with a dropdown menu showing "WAN1", and "Remark" with an empty text box and "(Optional)" label. At the bottom, there are "Cancel" and "Save" buttons.

The port mapping policy has been added successfully. See the following figure.

The screenshot shows the "Port Mapping" configuration page. At the top, there is a "Port Mapping" title and a "Port Mapping" section with "Enable" (selected) and "Disable" radio buttons. Below this is an "Add" button. A table lists the port mapping entries. The table has columns: Internal IP Address, Internal Port, External Port, Protocol, Interface, Remark, Status, and Operation. The first entry is: 192.168.0.250, 9999, 9999, TCP, WAN1, -, Enabled. The "Operation" column contains "Edit", "Disable", and "Delete" icons.

Internal IP Address	Internal Port	External Port	Protocol	Interface	Remark	Status ↓	Operation
192.168.0.250	9999	9999	TCP	WAN1	-	Enabled	<a href="#">Edit</a> <a href="#">Disable</a> <a href="#">Delete</a>

3. Set the fixed IP address assigned to the server host.

1) Navigate to **Network > DHCP Settings > DHCP Reservation**, and Click **Add**.

2) Set the following rules, and click **Save**.

- Set **Terminal Name**, which is **Web Server** in this example.
- Set **IP Address** assigned to the server host, which is **192.168.0.250** in this example.
- Set **MAC Address** of the server host, which is **C8:9C:DC:60:54:69** in this example.

- Set **Remark**, which is **Web Server Address** in this example.

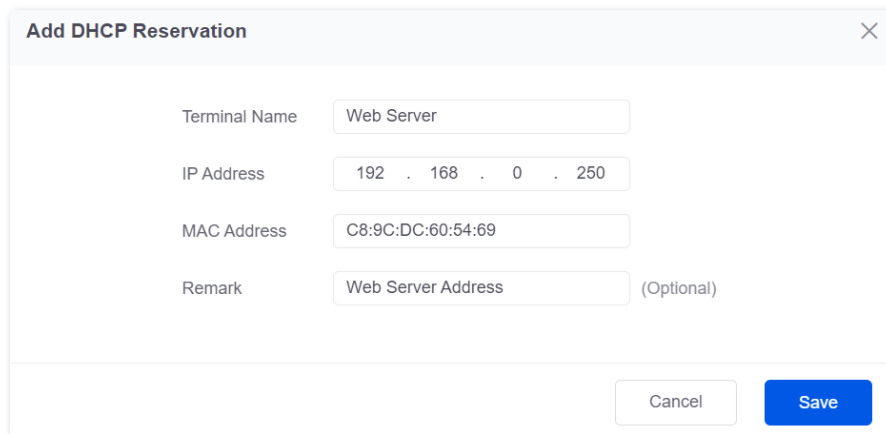

The screenshot shows a dialog box titled "Add DHCP Reservation". It has a close button (X) in the top right corner. The form contains the following fields:

- Terminal Name: Web Server
- IP Address: 192 . 168 . 0 . 250
- MAC Address: C8:9C:DC:60:54:69
- Remark: Web Server Address (Optional)

At the bottom right, there are two buttons: "Cancel" and "Save".

----End

The fixed IP address is reserved successfully. See the following figure.

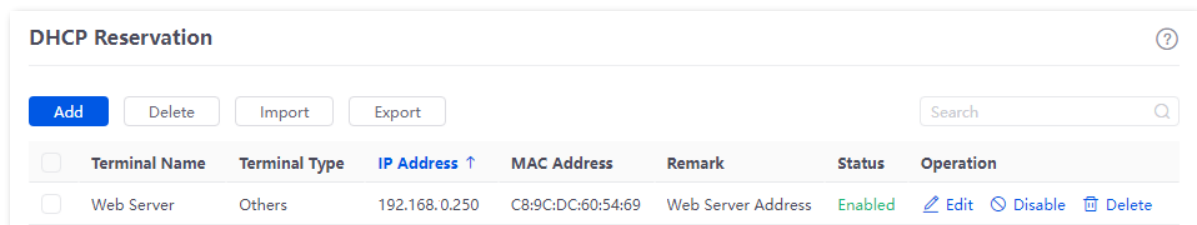

The screenshot shows a table titled "DHCP Reservation". Above the table are buttons for "Add", "Delete", "Import", and "Export", and a search bar. The table has the following columns: Terminal Name, Terminal Type, IP Address, MAC Address, Remark, Status, and Operation. The first row of data is:

Terminal Name	Terminal Type	IP Address	MAC Address	Remark	Status	Operation
Web Server	Others	192.168.0.250	C8:9C:DC:60:54:69	Web Server Address	Enabled	Edit Disable Delete

## Verification

Internet users can successfully access the intranet server by using the **Intranet service application layer protocol name://WAN port IP address**. If the intranet service port is not the default port number, the access address is **Intranet service application layer protocol name://WAN port IP address:External port**.

In this example, the access address is `http://202.105.11.22:9999`.

You can find the router's current WAN port IP address on the [Internet Settings](#) page.

If [DDNS](#) is enabled on the WAN port, internet users can also access the intranet server by using **Intranet service application layer protocol name://WAN port domain name:External port**.



If internet users still cannot access the LAN server after the configuration is completed, try the following methods one by one:

- Ensure that the internal port you entered is correct.
- Maybe the system firewall, anti-virus software and security guard in the LAN server blocked internet user access. Disable these programs and try again.

## 10.2.8 DNS cache

The Domain Name Server (DNS) is used to manage the relationships between domain names and IP addresses so that domain names can be mapped with corresponding IP addresses. Users accessing domain names are accessing the mapped IP addresses through DNS domain name parsing.

The DNS cache function enables the router to cache DNS-resolved information about websites visited by users. When other users access the websites, the router directly uses the information in the cache to direct users to the websites without accessing the DNS server. This improves the website accessing speed.

[Log in to the web UI of the router](#), and navigate to **More > Virtual Service > DNS Cache** to access the page. The DNS cache function is enabled by default.

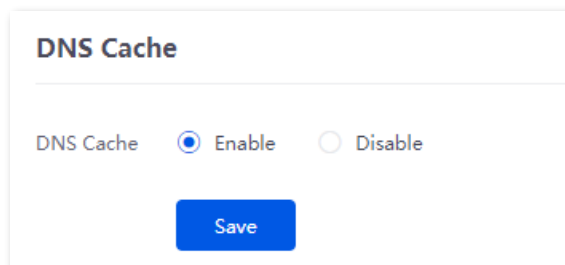

## 10.3 Maintenance service

### 10.3.1 Remote web management

#### Overview

Generally, you can [log in to the web UI of the router](#) only when you connect to the LAN port or the wireless network of the router. However, the Remote Web Management function enables access to the web UI remotely through the WAN port in special cases (like when you need remote technical support).

[Log in to the web UI of the router](#), and navigate to **More > Maintenance Service > Remote Web Management** to enter the page. On this page, you can enable or disable the remote web management and restrict the hosts that can remotely log in to the local router.

The remote web management function is disabled by default. The following displays the page when the function is enabled.

**Remote Web Management**

Remote Web Management  Enable  Disable

Specified WAN Port WAN1

Remote IP Address All Addresses

Remote Management Address http://fvhk6gao.web.ip-com.com.cn:8080 Copy

Save

#### Parameter description

Parameter	Description
Remote Web Management	Used to enable or disable the remote web management function.
Specified WAN Port	Specifies the WAN port used when accessing the web UI of the router from the internet remotely. When multiple WAN ports are available, you can select any one of them.

Parameter	Description
Remote IP Address	<p>Specifies the IP address of the device that can access the web UI of the router remotely.</p> <ul style="list-style-type: none"> <li>- <b>All Addresses:</b> Devices with any IP address on the internet can access the web UI of the router. For network security, this option is not recommended.</li> <li>- <b>Specified Address:</b> Only devices with specified IP addresses can access the web UI of the router. If the device is in the local area network, the IP address (public IP address) of the gateway of the device should be filled in.</li> </ul>
Remote Management Address	<p>Specifies the domain name used for remote access. This domain name is generated by the router, and internet users can access the web UI of the router using the domain name when the Remote Web Management function is enabled.</p>

## Example of configuring remote web management

### Networking requirements

An enterprise uses the enterprise router to set up a network. The network administrator encountered a problem during network setup and needs the IP-COM technical support to remotely log in to the web UI of the device to perform analysis and troubleshooting.

### Solution

You can use the Remote Web Management function to meet the requirements.

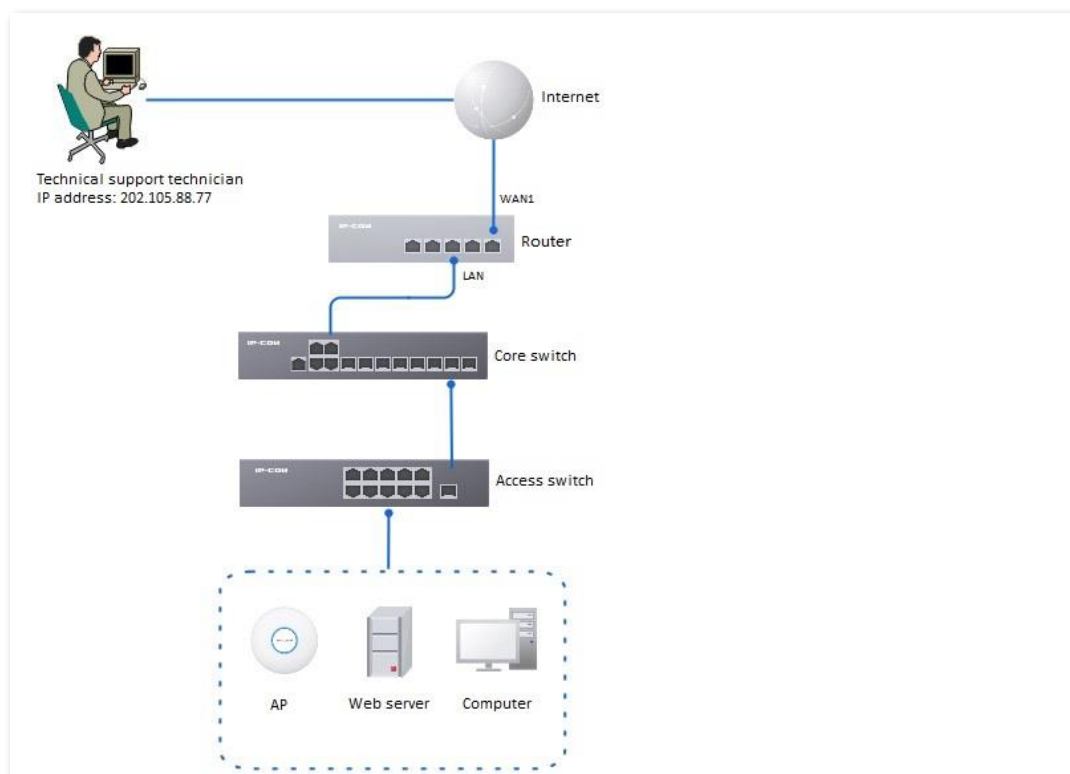

## Configuration procedure

1. [Log in to the Web UI of the router](#), and navigate to **More > Maintenance Service > Remote Web Management**.
2. Enable the **Remote Web Management** function.
3. Set **Specified WAN Port**, which is **WAN1** in this example.
4. Set **Remote IP Address** as **Specified Address**. And enter the IP address of the computer supported by IP-COM technology, which is **202.105.88.77** in this example.
5. Click **Save**.

**Remote Web Management**

Remote Web Management  Enable  Disable

Specified WAN Port

Remote IP Address

Remote Management Address

----End

## Verification

The IP-COM technical support technician can log in to the web UI of the router by visiting <http://fvhk6gao.web.ip-com.com.cn:8080> on the computer (the IP address of the computer is 202.105.88.77).



## 10.3.2 Security settings

[Log in to the web UI of the router](#), and navigate to **More > Maintenance Service > Security Settings** to enter the page. On this page, you can enable corresponding attack defense functions according to the actual network conditions.

**Security Settings**

Block Ping from WAN  Enable  Disable

LAN DDoS Attack Defense  Enable  Disable

ARP Attack Defense  Enable  Disable

Binary Association  Enable  Disable

Web Login Protocol  HTTPS  HTTP

Login Timeout Interval

**Save**

### Parameter description

Parameter	Description
Block Ping from WAN	Used to enable or disable the block Ping from WAN function. With this function enabled, when a WAN host pings the IP address of the WAN port on the router, the router automatically ignores the Ping request to prevent itself from being exposed and defend against external Ping attacks.
LAN DDoS Attack Defense	Used to enable or disable the LAN DDoS attack defense function. DDoS is abbreviated for Distributed Denial of Service. The DDoS attack allows an attacker to exhaust the resources of a system, making the system unable to properly provide services. With this function enabled, the router can defend common DDoS attacks from the internal network.
ARP Attack Defense	Used to enable or disable the ARP attack defense function. With this function enabled, the router can identify ARP spoofing in the LAN and record the MAC address of the attacker.
Binary Association	Used to enable or disable the binary association function. With this function enabled, only devices whose IP addresses are bound with MAC addresses in the list to access the internet.

Parameter	Description
Web Login Protocol	<p>Specifies the mode to log in to the web UI of the router, including <b>HTTPS</b> and <b>HTTP</b>. The default mode is <b>HTTPS</b>.</p> <ul style="list-style-type: none"><li>– <b>HTTPS</b>: Hyper Text Transfer Protocol Secure (HTTPS) uses SSL/TLS to encrypt data packets based on HTTP and establishes a secure channel, thus ensuring the security of the data transmission process. It ensures the security of data transmission and the authenticity of the website via HTTPS Access.</li><li>– <b>HTTP</b>: Hyper Text Transfer Protocol (HTTP) is a specification for communication between browsers and servers.</li></ul>
Login Timeout Interval	<p>Used to set the login timeout interval. After logging in to the web UI of the router, you will be automatically logged out when no operation is performed within the defined time period.</p>

### 10.3.3 Cloud maintenance

#### Overview



The cloud maintenance function may be unavailable for some versions. Please refer the actual product.

The ProFi cloud platform is a cloud platform established by IP-COM, providing central management for IP-COM devices that support cloud management.

With this router managed by the ProFi cloud platform, you can configure and check the parameters of the router on the ProFi cloud platform. You can also configure and check these parameters on the web UI of the router.

[Log in to the web UI of the router](#), and navigate to **More > Maintenance Service > Cloud Maintenance** to enter the page. On this page, you can configure the Cloud Maintenance function of the router.

The Cloud Maintenance function is disabled by default. The following displays the page when the function is enabled.

### Cloud Maintenance ?

Cloud Maintenance  Enable  Disable

After the Cloud Maintenance function is enabled, a device can be associated by the ProFi Cloud Platform.

Management Mode Cloud Hosting

Cloud Hosting: It supports functions configuration through cloud and local web UI.  
Local Hosting: The device can be normally associated with the cloud, but the cloud configuration information cannot be obtained. Configurations can be modified only after local login.

Unique Cloud Code

Unique Cloud Code is used to associate the device with an ProFi Cloud Platform account. You can obtain Unique Cloud Code either from ProFi Cloud Platform (<https://imsen.ip-com.com.cn>) or on the Account Center page of the IP-COM CloudFi App.

Device Info Report  Enable  Disable

Note: If the Device Info Report function is disabled, the device cannot be managed by the cloud, and relevant functions in Cloud Maintenance are not available.

Save

## Parameter description

Parameter	Description
Cloud Maintenance	Used to enable or disable the cloud maintenance function.
Management Mode	<p>Specifies the management mode of cloud maintenance.</p> <ul style="list-style-type: none"> <li>– <b>Cloud Hosting:</b> It is applicable to unified managed projects that are maintained on the IP-COM ProFi cloud platform (ProFi Cloud web UI or ProFi App). The router can be managed by the IP-COM ProFi cloud platform and the configuration information of relevant functions is delivered by the ProFi cloud platform. When logging in to the web UI of the router locally, you can also configure the functions.</li> <li>– <b>Local Hosting:</b> It is applicable for scenarios where the project is centrally managed and viewed. The router can be managed on the IP-COM ProFi cloud platform, but all function configurations need to be set on the web UI of the router.</li> </ul>
Unique Cloud Code	Specifies the ProFi cloud platform account associated with the device. You can obtain it from the IP-COM ProFi cloud platform ( <a href="https://imsen.ip-com.com.cn">https://imsen.ip-com.com.cn</a> ) or the IP-COM ProFi App.
Device Info Report	<p>Used to enable or disable the device info report function.</p> <p>If the Device Info Report function is enabled, the router can be managed by the ProFi cloud platform. The configuration information of the router will be reported to the cloud platform.</p>

## Example of configuring cloud maintenance on ProFi Cloud platform

### Networking requirements

An enterprise uses the enterprise router to set up a network and has successfully connected to the internet. The requirements are managing the router remotely and delivering related configurations.

### Solution

You can use the Cloud Management function of the router and ProFi Cloud platform to meet the requirements.

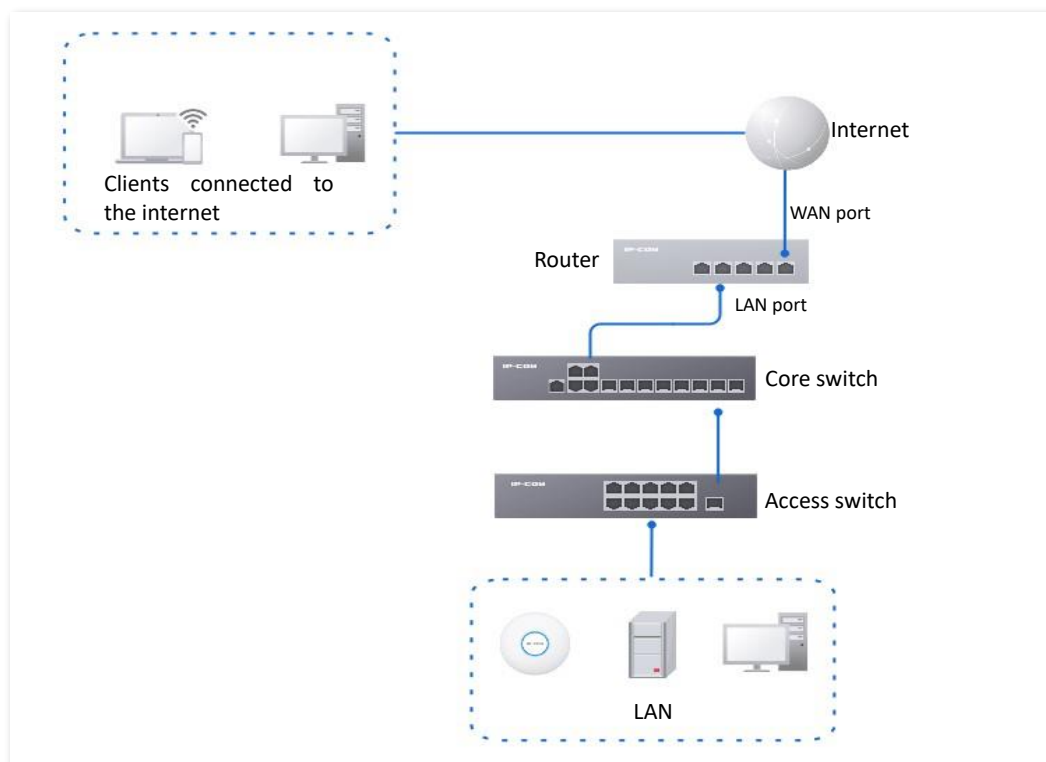

### Configuration procedure



Tip

- Before configuring the cloud maintenance function of the router, ensure that the router is connected to the internet.
- The system version V1.5.6 of the ProFi cloud management is used as an example. The actual operation and UI interface of the system version prevail.

1. Log in to the IP-COM ProFi Cloud platform and obtain unique cloud code.
  - 1) On a computer that has connected to the Internet, start a web browser, visit <https://imsen.ip-com.com.cn>, and log in to the IP-COM ProFi cloud platform.



- 2) Click **Add** at the upper right corner and select **Unique Cloud Code**.

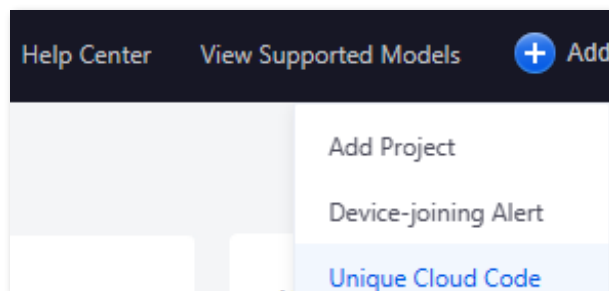

- 3) Click **Copy** to copy the **Unique Cloud Code**.

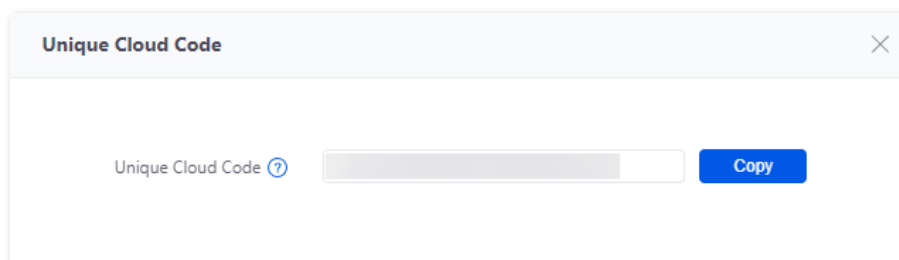

2. Enable the cloud maintenance function for the router.
  - 1) [Log in to the web UI of the router](#), and navigate to **More > Maintenance Service > Cloud Maintenance**.
  - 2) Set **Cloud Maintenance** to **Enable**, and set **Management Mode** as required (**Cloud Hosting** for example here).
  - 3) Enter the **Unique Cloud Code** and set **Device Info Report** to **Enable**. Confirm the prompt information (if it pops up) and click **OK**. Then click **Save**.

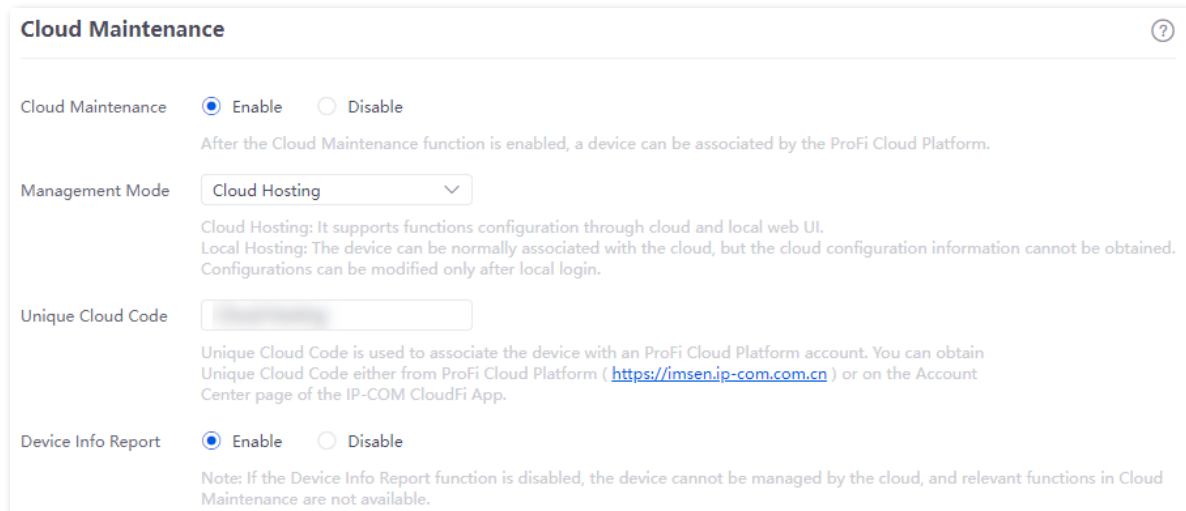

3. Add a project on the ProFi Cloud platform and add the router to the project.

- 1) Log in to the ProFi cloud platform. Click **Add** in the upper right corner and select **Device-joining Alert**.
- 2) Select the router to be added to the project and click **Add Device to Project**. The following figure is for reference only.

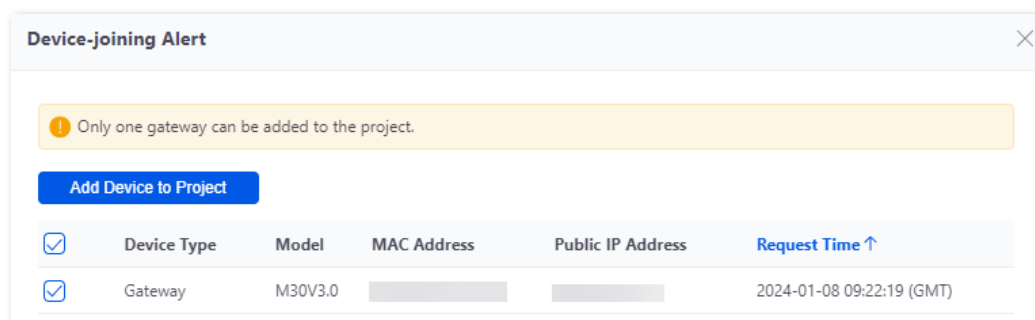

- 3) Select the project to which you want to add the router. The following figure is for reference only.
  - If the project has already been created, select **Existing Project**, select the corresponding project in the **Project Name** drop-down menu, and then click **Confirm**.

The screenshot shows a dialog box titled "Add Device to Project". It has a close button (X) in the top right corner. The "Add Device to" section has two radio buttons: "Existing Project" (selected) and "Add Project". Below this are several dropdown menus: "Project Name" (with the text "Select a project"), "Project Scenario" (with the text "Select Project Scenario"), "Project Location" (with the text "Select Project Location"), "Time Zone" (empty), and "Project Type" (with the text "Traditional WLAN"). At the bottom right, there are "Cancel" and "Confirm" buttons.

- If you want to create a new project, select **Add Project**, set the **Project Name**, **Project Scenario** and **Project Location**, and then click **Confirm**.

The screenshot shows the same "Add Device to Project" dialog box, but now "Add Project" is selected. The "Project Name" field is now a text input with the placeholder "Enter Project Name". The "Project Scenario" dropdown has "Select Project Scenario", "Project Location" has "Select Project Location", "Time Zone" has "(GMT+08:00) Beijing, Chongqi", and "Project Type" has "Traditional WLAN". The "Cancel" and "Confirm" buttons are at the bottom right.

Added successfully. You can enter the **Project** page to view details. The following figure is for reference only.

The screenshot shows the IP-COM Project management interface. The top navigation bar includes "IP-COM", "Help Center", "View Supported Models", "Add", "13456", and "Demo". The main content area is titled "Project" and has a sidebar with "Overview" and "Project". There are filters for "All (2)", "Traditional WLAN (2)", and "Cable-free WLAN (0)". An "Add Project" button and a search bar are also present. Below is a table with the following data:

No.	Status ↓	Project Name	Project Property	Project Type	Project Scenario	Project Location	Online Devices	Offline Devices	Unread Alarms	Operation
1	Online	xx Enterprise Network	By Creation	Traditional WLAN	Office	Australia-New South Wales	1	-	-	Edit Delete Share

---End

## Verification

After the configuration is completed, the router can be managed through the ProFi Cloud platform, and all its configuration information is delivered by the ProFi Cloud platform.

## Example of configuring cloud maintenance on ProFi App

### Networking requirements

An enterprise uses the enterprise router to set up a network and has successfully connected to the Internet. The requirements are managing the router remotely and delivering related configurations.

### Solution

You can use the Cloud Management function of the router and ProFi App to meet the requirements.

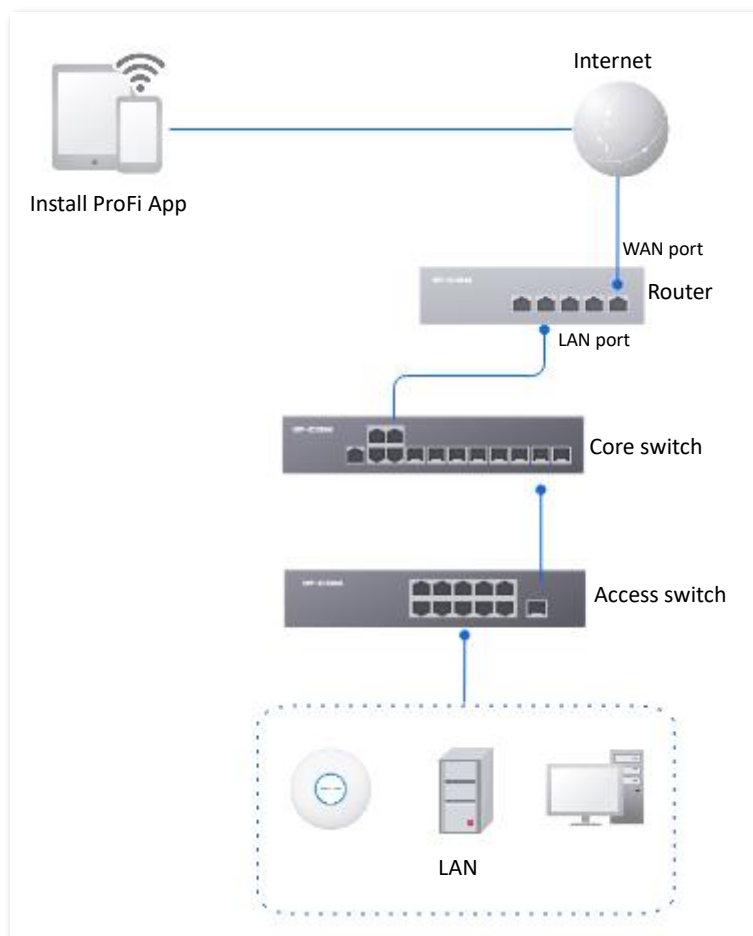



## Configuration procedure (method 1)



Before configuring the cloud maintenance function of the router, ensure that the router is connected to the Internet.

---

1. Add a project on the ProFi App. (Skip if performed)
2. Add the router to the project.

You can view the **Help Documentation** of the ProFi App on the **Help Center** page of the ProFi App for specific methods.

## Configuration procedure (method 2)



Before configuring the cloud maintenance function of the router, ensure that the router is connected to the Internet.

---

1. Scan the QR code to download the ProFi App.



Scan to download the ProFi App

ProFi App

2. Log in to the ProFi App and obtain **Unique Cloud Code**.
3. Enable the cloud maintenance function for the router.
  - 1) [Log in to the web UI of the router](#), and navigate to **More > Maintenance Service > Cloud Maintenance**.
  - 2) Enable the **Cloud Maintenance** function, and set **Management Mode** as required (**Cloud Hosting** for example here).
  - 3) Enter the **Unique Cloud Code** and set **Device Info Report** to **Enable**. Confirm the prompt information (if it pops up) and click **OK**. Then click **Save**.

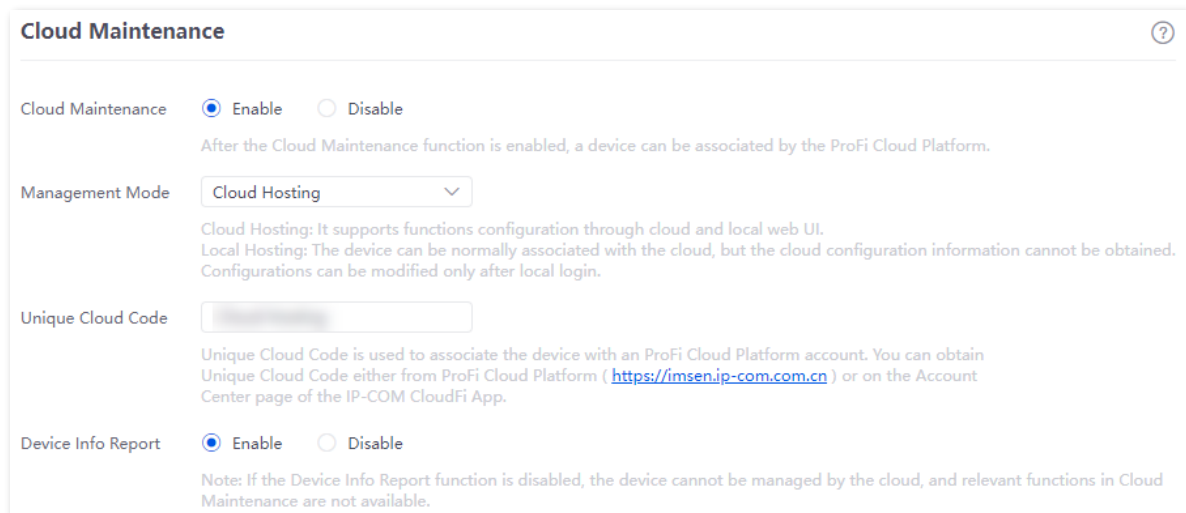

4. Add a project on the ProFi App. (Skip if performed)
5. Add the router to the project.

You can view the **Help Documentation** of the ProFi App on the **Help Center** page of the ProFi App for specific methods.

---End

## Verification

After the configuration is completed, the router can be managed through the ProFi App, and all its configuration information is delivered by the cloud platform.

## 10.3.4 Remote debugging

### Overview

This function can be used for remote network debugging by professional engineers. After enabling this function, professional engineers can remotely connect to the router through Secure Shell (SSH) and perform remote debugging.

[Log in to the web UI of the router](#), and navigate to **More > Maintenance Service > Remote Debugging** to enter this page. On this page, you can configure the remote debugging function. By default, this function is disabled. The following displays the page when the function is enabled.

### Remote Debugging

Remote Debugging  Enable  Disable

Device Public Key 

```
ssh-rsa
AAAAB3NzaC1yc2EAAAADAQAB
BAAABAQC/MnJZs8lY31rBdg18
f4Bw19u4H8BIKz1pDYmHFJvK
Udl2S721UUs1+l/oOcc91EbeVwj
```

Server IP Address  (Optional)

Server Port  (Optional)

Remote Debugging Address

Status Disconnected

### Parameter description

Parameter	Description
Remote Debugging	Used to enable or disable the remote debugging function.
Device Public Key	Specifies the RSA public key of the device. The device's public key has been preset in the authorization list in the default server. If the default server is not used, you need to add the device public key on the customized server.
Server IP Address	Specifies the IP address of the external server, which must be a public IP address. When it is left blank, the default server is used.
Server Port	Specifies the service port of the external server. When it is left blank, the default server port is used.
Remote Debugging Address	Specifies the address for remotely accessing this device using SSH.
Status	Specifies the connection status between this device and the server.

## Remotely connect to the router using an SSH tool

### Enable the remote debugging function

1. [Log in to the web UI of the router.](#)
2. Navigate to **More > Maintenance Service > Remote Debugging.**

3. Enable the **Remote Debugging** function. Retain default settings for other parameters and click **Save**.

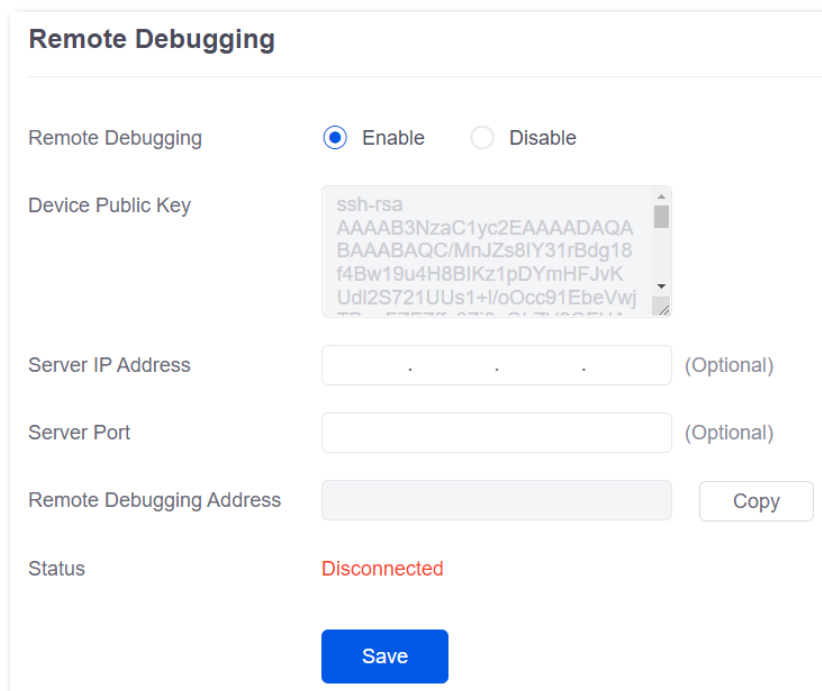

The screenshot shows the 'Remote Debugging' configuration panel. At the top, the title 'Remote Debugging' is displayed. Below it, there are two radio buttons: 'Enable' (selected) and 'Disable'. The 'Device Public Key' field contains a long alphanumeric string. Below this, there are three input fields: 'Server IP Address' (with a placeholder '.'), 'Server Port', and 'Remote Debugging Address' (with a 'Copy' button next to it). The 'Status' field shows 'Disconnected' in red text. At the bottom, there is a blue 'Save' button.

Wait for a moment. When **Status** is displayed as **Connected**, you can remotely connect to the router by entering the destination IP address in the SSH tool.

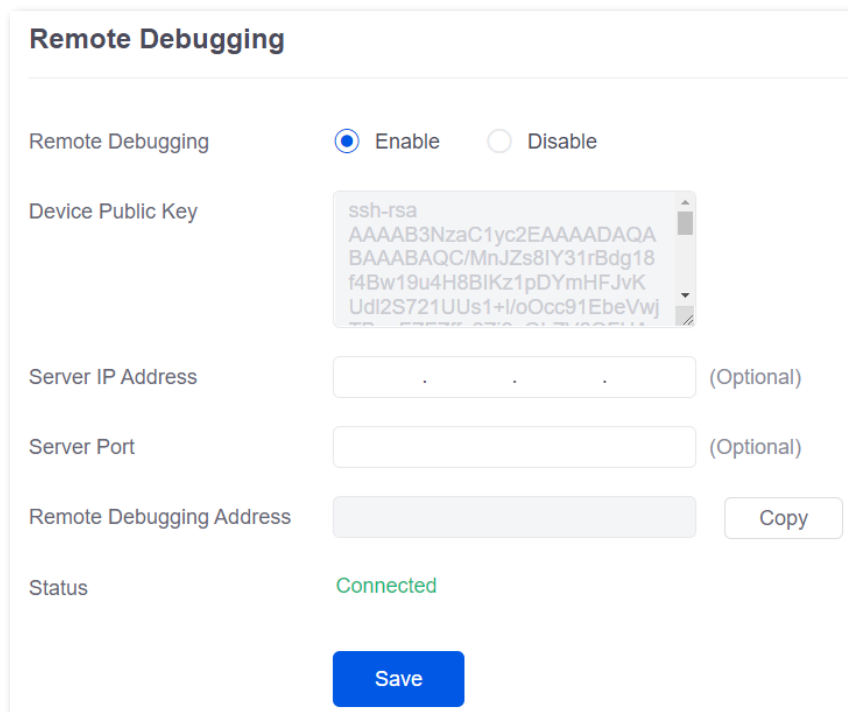

This screenshot is identical to the one above, but the 'Status' field now shows 'Connected' in green text. The 'Save' button remains at the bottom.

## Remotely connect to the router using an SSH tool

1. Run an SSH client tool (PuTTY used for example here) on a computer connected to the network.
2. Set **Connection Type** to **SSH**.
3. Set **Host Name (or IP address)** to the remote debugging address and port to be accessed.

The following figure shows an example.

4. Click **Open**.

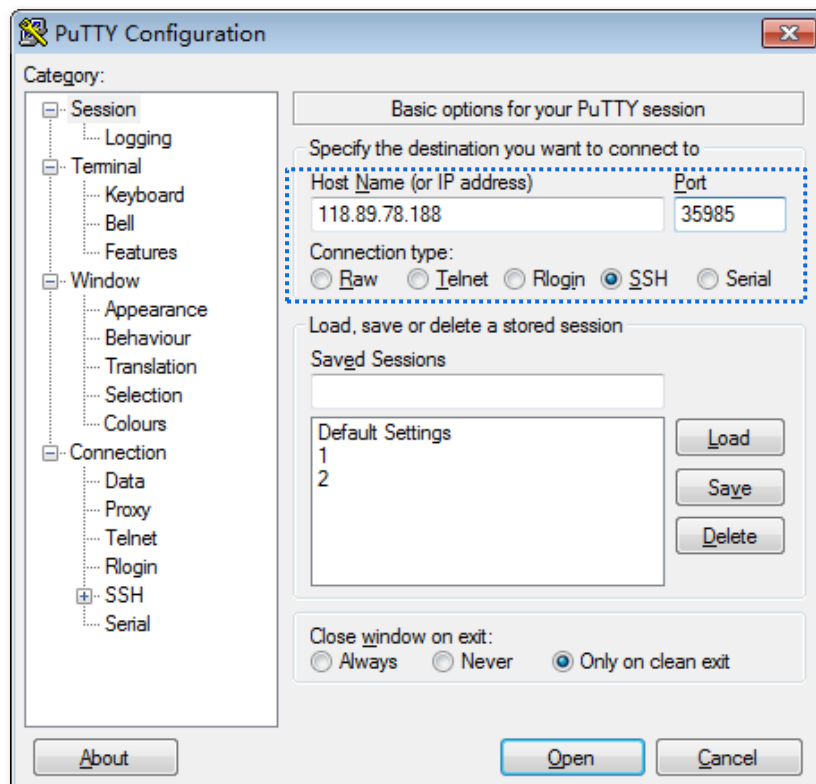

----End

If the following figure is displayed, the router is connected successfully.

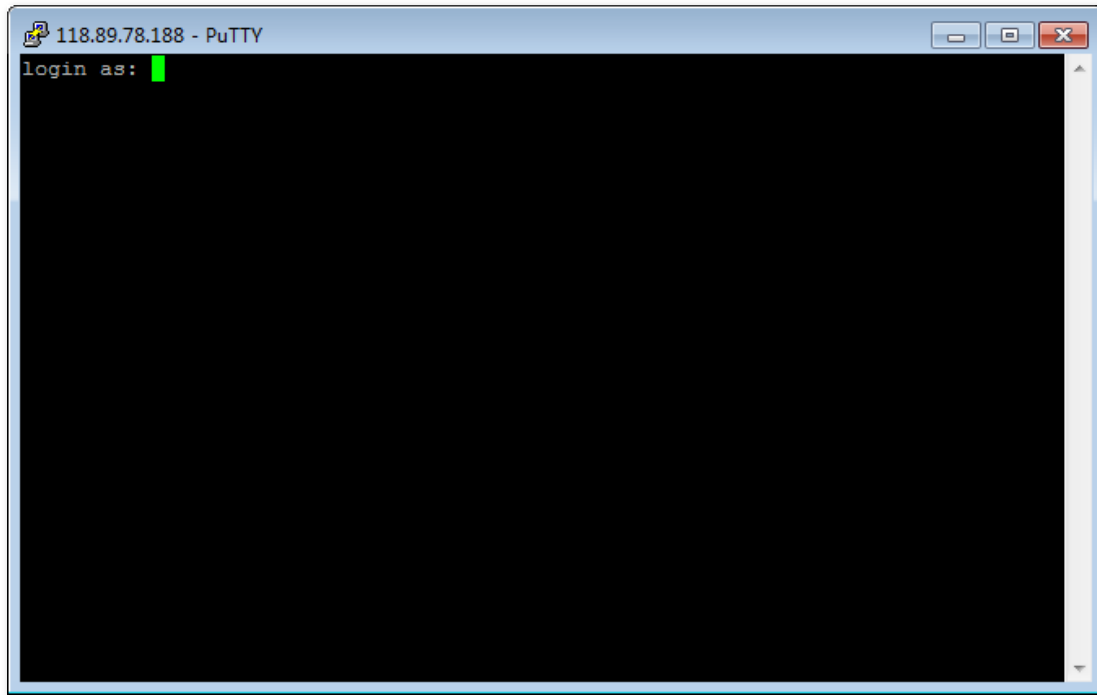

## 10.4 VPN

### 10.4.1 Overview

Virtual Private Network (VPN) is a special network set up on the public network (generally the internet). It exists only logically and does not have any physical lines. The VPN technology is widely used in enterprise networks and is used to achieve resource sharing between a subsidiary and the headquarters, and at the same time, protects these resources from being exposed to other users on the internet.

The typical network topology of VPN is as follows:

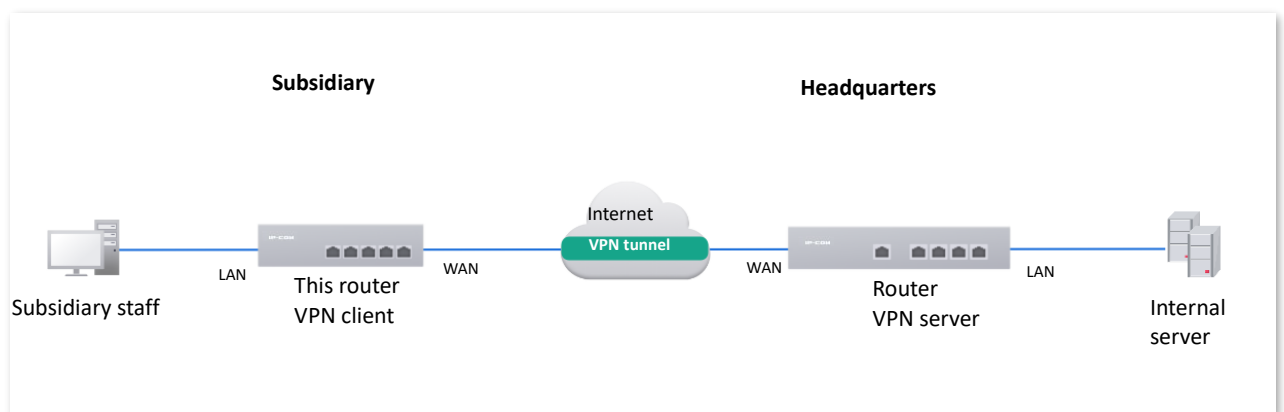

This router supports Point to Point Tunneling Protocol (PPTP) server, Layer 2 Tunneling Protocol (L2TP) server and IP Security (IPSec).

#### ■ Layer-2 VPN channel protocol: PPTP, L2TP

Layer-2 VPN channel protocol is used to transmit Layer-2 (data link layer) network protocol, where frames at the data link layer are transmitted in the tunnel.

PPTP encapsulates Point to Point Protocol (PPP) frames into IP data packets and transmits data over the internet. L2TP encapsulates PPP frames into different data packets for transmission according to different network types.

#### ■ Layer-3 VPN channel protocol: IPSec

Layer-3 VPN channel protocol is used to transmit Layer-3 (network layer) network protocol, where groups at the network layer are transmitted in the tunnel.

IPSec encapsulates data in a tunneling protocol and relies on the third layer to transmit the networks only for TCP/IP.

Compared with the Layer-2 VPN channel protocol, the Layer-3 VPN channel protocol has better security and reliability. The second-layer tunnel is generally terminated on the user-side device, which has high requirements for the security of the client and firewall technology. While the third-layer tunnel is generally terminated at the Internet Service Provider (ISP) gateway, which does not have high requirements for the security of the client.

## 10.4.2 PPTP/L2TP

### Overview

#### ■ PPTP protocol

PPTP is a layer 2 tunneling technology based on the PPP, which supports on-demand and multi-protocol VPN. PPTP enables secure remote access connections by creating a VPN across TCP/IP-based data networks.

The implementation of PPTP is based on the Client/Server (C/S) model, and a PPTP tunnel is established between the client and the server. The client uses the account information provided by the server to dial up to connect to the server. The server listens for services on TCP port 1723 by default to realize the communication between the two parties.

The communication of PPTP needs to establish two connections, namely Control Connection and Data Connection. The control connection uses TCP as the transmission protocol, which is used for call control and management, and is responsible for establishing, maintaining and dismantling the data tunnel between the client and the server. The data connection uses the PPP protocol to encapsulate the original packets and uses the enhanced Generic Routing Encapsulation (GRE) protocol as a tunneling protocol, and adds new IP headers for data routing on the internet.

In terms of security, PPTP uses the authentication mechanism provided by PPP, and supports Password Authentication Protocol (PAP), Challenge Handshake Authentication Protocol (CHAP), Microsoft Challenge Handshake Authentication Protocol (MS-CHAP) and other authentication methods. Microsoft Point-to-Point Encryption (MPPE) protocol can be selected for encryption. MPPE encryption technology supports encryption with three lengths of 40, 56 and 128 bits, and its security is generally considered to be relatively weak. Therefore, if sensitive data transmission is involved, PPTP VPN is generally not recommended.

#### ■ L2TP protocol

L2TP is a Layer 2 VPN tunneling protocol. The implementation of L2TP is based on the Client/Server (C/S) model, and an L2TP tunnel is established between the client and the server. The client chooses an idle port to send the message to the UDP port 1701 of the server. After the server receives the message, it also chooses an idle port to send the message back to the client. The port selection of both parties remains unchanged during the time that the tunnel is connected.

The L2TP protocol does not provide connection security, but it can rely on the authentication provided by PPP (such as CHAP and PAP), which means L2TP has all the security features that PPP has. L2TP can be combined with IPsec to achieve data security, which makes the data transmitted through L2TP more difficult to attack. L2TP can also use tunnel encryption technology, end-to-end data encryption or application layer data encryption and other schemes on top of L2TP to improve data security according to specific network security requirements.



## Configure PPTP or L2TP server

The router works as a PPTP or L2TP server and can connect to PPTP or L2TP clients.

[Log in to the web UI of the router](#), and navigate to **More > VPN Service > VPN Server** to enter the page.

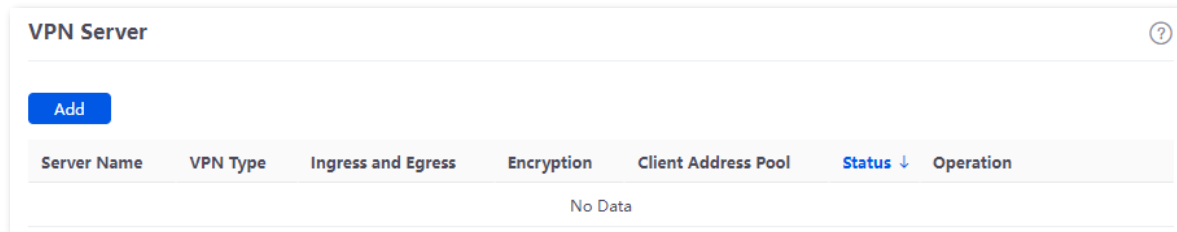

You can click **Add** to configure parameters and then click **Save**.

### Parameter description

Parameter	Description
Server Name	Specifies the name of the VPN server.
VPN Type	Specifies the VPN server type of the router, including <b>PPTP</b> and <b>L2TP</b> . Both PPTP and L2TP are Layer 2 VPN tunneling protocols, use Point-to-Point Protocol (PPP) for data encapsulation, and add additional headers to the data. <ul style="list-style-type: none"> <li>- <b>PPTP</b>: The router works as a PPTP server and can connect to PPTP clients.</li> <li>- <b>L2TP</b>: The router works as a L2TP server and can connect to L2TP clients.</li> </ul>
Ingress and Egress	Specifies the WAN port used for the connection between the VPN server and VPN client. The IP address or domain name of the WAN port is the <b>Server IP Address/Domain Name</b> of the VPN client.

Parameter	Description
Encryption	<ul style="list-style-type: none"> <li>- <b>PPTP</b>: Specifies whether to enable the 128-bit data encryption. The encryption settings of PPTP server and PPTP client must be consistent. Otherwise, communications cannot be conducted normally.</li> <li>- <b>L2TP</b>: Specifies whether to encrypt data packets by enabling the IPSec. The encryption settings of L2TP server and L2TP client must be consistent. Otherwise, communications cannot be conducted normally.</li> </ul>
Pre-shared Key	Specifies the pre-shared key of the L2TP server and the L2TP client. When the L2TP tunnel uses IPSec for encryption, both the L2TP client and the L2TP server use this pre-shared key to authenticate each other. The pre-shared key of the L2TP client and the L2TP server should be the same.
Client Address Pool	Specifies the IP address range within which the VPN server can assign IP addresses to VPN clients.
Status	Specifies the current status of the VPN server policy, including <b>Enabled</b> and <b>Disabled</b> .

## Configure user management



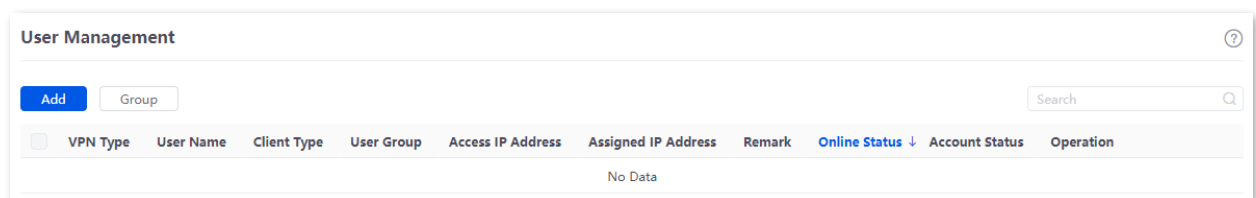

[Log in to the web UI of the router](#), and navigate to **More > VPN Service > User Management** to enter the page.

On this page, you can configure PPTP or L2TP user accounts. When the PPTP or L2TP server is enabled, VPN users need to use accounts to dial up the VPN on the router.



You can click **Add** to a new user policy.

## Parameter description

Parameter	Description
VPN Type	Specifies the service type of the client. <b>Automatic</b> indicates that the client can be either a PPTP user or a L2TP user.
User Name	Specifies the user name required for the VPN connection.
Password	Specifies the password required for the VPN connection.
User Group	Specifies the user group that the VPN client is added. After the VPN account is added to a user group, the access permission of subsequent users on the internal server is controlled. The user group must be configured in <a href="#">User Group</a> .
Client Type	Specifies the type of the VPN client. <ul style="list-style-type: none"><li>– Select <b>Terminal</b> when the VPN client is a single host.</li><li>– Select <b>Network Device</b> when the VPN client is a network.</li></ul>
Client Subnet	Specifies the IP address range of the client intranet. It is available only when the <b>Client Type</b> is set to <b>Network Device</b> .
Access IP Address	Specifies the IP address of the actual physical network adapter of the VPN client.
Assigned IP Address	Specifies the IP address that the server assigns to VPN client.
Remark	Specifies the introduction to the user policy. The remark is optional.
Online Status	Specifies whether the client is online.
Account Status	Specifies the status of the user policy.
Operation	Used to edit, enable, disable or delete the VPN user policy. <ul style="list-style-type: none"><li> <b>Edit</b>: Used to modify the VPN user policy.</li><li> <b>Enable</b>: Used to enable the VPN user policy.</li><li> <b>Disable</b>: Used to disable the VPN user policy.</li><li> <b>Delete</b>: Used to delete the VPN user policy.</li></ul>

## Configure PPTP or L2TP client

The router works as a PPTP or L2TP client and can connect to PPTP or L2TP server.

[Log in to the web UI of the router](#), and navigate to **More > VPN Client** to enter the page. Set **VPN Client** to **Enable** and configure related parameters. Then click **Save**.

### VPN Client

---

VPN Client  Enable  Disable

Client Type  PPTP  L2TP

WAN Port WAN1 ▼

Server IP Address/Domain Name

User Name

Password  🗕

Encryption  Enable  Disable

VPN Agent  Enable  Disable

Remote LAN

Remote Subnet Mask

Status Disconnected

Save

### Parameter description

Parameter	Description
VPN Client	Used to enable or disable the VPN client function. After this function is enabled, the router works as a VPN client.
Client Type	Specifies the VPN server type of the router, including <b>PPTP</b> and <b>L2TP</b> . Both PPTP and L2TP are Layer 2 VPN tunneling protocols, use Point-to-Point Protocol (PPP) for data encapsulation, and add additional headers to the data. <ul style="list-style-type: none"> <li>- <b>PPTP</b>: Select <b>PPTP</b> when the VPN server is a PPTP server.</li> <li>- <b>L2TP</b>: Select <b>L2TP</b> when the VPN server is a L2TP server.</li> </ul>
WAN Port	Specifies the WAN port of the PPTP or L2TP client for setting up a connection with the PPTP or L2TP server.
Server IP Address/Domain Name	Specifies the IP address or domain name of the VPN server. Generally, it is the IP address or domain name of the WAN port with the PPTP/L2TP server function enabled on the peer VPN router.
User Name	Specify the user name and password assigned by the VPN server to the VPN client.
Password	

Parameter	Description
Encryption	Specifies whether to enable 128-bit data encryption. The value of this parameter must be consistent with that of the server. Otherwise, the client is unable to communicate with the server. Only PPTP VPNs support this parameter.
VPN Agent	With this function enabled, clients in the LAN can obtain IP addresses from the VPN server to access the internet.
Remote LAN	Specifies the network segment of the LAN of the PPTP or L2TP server.
Remote Subnet Mask	Specifies the subnet mask of the LAN of the PPTP or L2TP server.
Status	Specifies the current connection status of the VPN client.

### 10.4.3 Example of configuring a PPTP/L2TP VPN

#### Networking requirements

The headquarters and subsidiary used enterprise-class routers (such as M30) to set up a network and successfully access the internet. The subsidiary staff need to access intranet resources through the internet, such as internal documents, office OA, ERP system, CRM system, and project management system.

#### Solution

Configure the enterprise-class router of the headquarters as the VPN server and the enterprise-class router of the subsidiary as the VPN client to enable remote users to securely access the intranet through the internet. PPTP VPN is taken for example here and the configuration of L2TP VPN is similar.

Assume that the WAN1 IP address of the headquarters' enterprise-class router is 202.105.11.22.

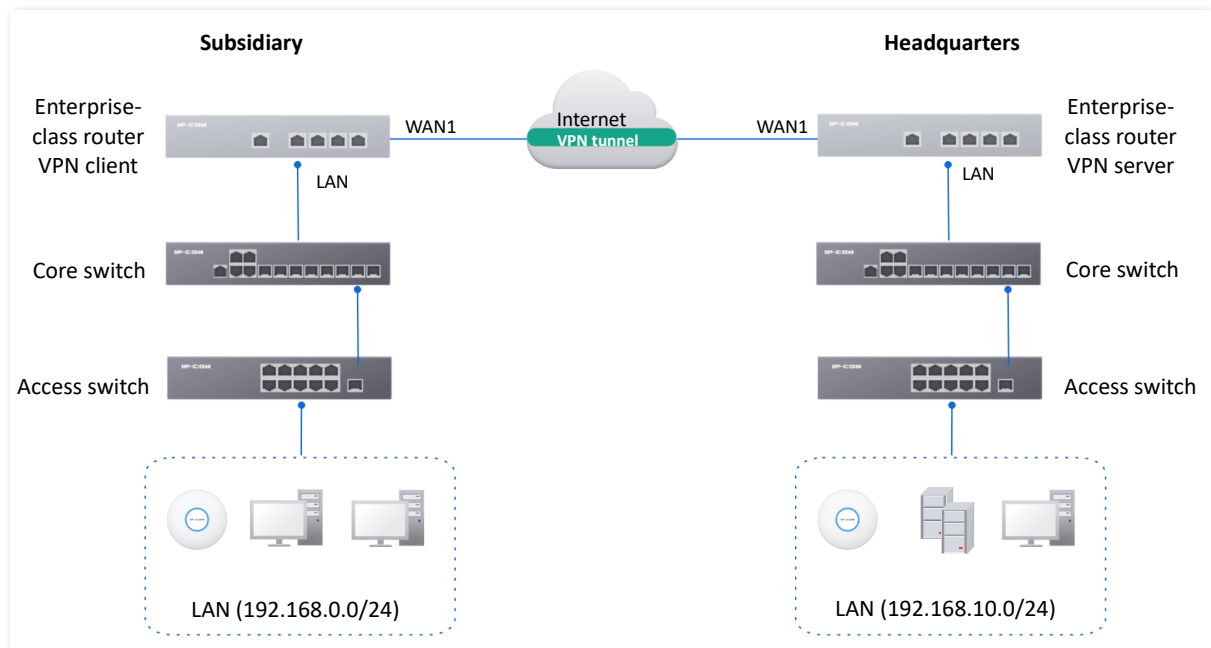

## Configuration procedure

Configure a router as the VPN server

Configure the other router as the VPN client

### I. Configure the enterprise-class router of the headquarters as the VPN server.

1. [Log in to the web UI of the router.](#)
2. Configure the PPTP server.

Server Name	VPN Type	Ingress and Egress	Encryption	Client Address Pool
PPTP Server	PPTP	WAN1	Encrypted	10.1.0.100-10.1.0.163

Navigate to **More > VPN Service > VPN Server**, click **Add** to configure the relevant parameters of the PPTP server, and click **Save**.

3. Configure the PPTP user.

The following table provides the examples of PPTP user parameters.

VPN Type	User Name	Password	User Group	Client Type	Client Subnet
PPTP	Subsidiary1	Subsidiary1	Subsidiary1 Staff	Network Device	192.168.0.0/24

1) Configure VPN user groups.

Navigate to **Audit > Group Policy > User Group**, click **Add** to configure VPN user groups for the subsidiary, and click **Save**.

2) Configure the PPTP user.

Navigate to **More > VPN Service > User Management**, click **Add** to configure the relevant parameters of the PPTP user, and click **Save**.

The screenshot shows a dialog box titled "Add User" with a close button (X) in the top right corner. The dialog contains the following fields and values:

- VPN Type: PPTP (dropdown menu)
- User Name: Subsidiary1 (text input)
- Password: ..... (password field with eye icon)
- User Group: Subsidiary1 Staff (dropdown menu)
- Client Type: Network Device (dropdown menu)
- Client Subnet: 192.168.0.0 / 24 (two text input fields)
- Remark: (Optional) (text input)

At the bottom right of the dialog, there are two buttons: "Cancel" and "Save".

## II. Configure the enterprise-class router of the subsidiary as the VPN client.

1. [Log in to the web UI of the router.](#)
2. Configure the PPTP client.
  - 1) Navigate to **More > VPN Client**, and enable the **VPN Client** function.
  - 2) Set **Client Type** to be consistent with the VPN server, which is **PPTP** in this example.
  - 3) Set **WAN Port**, which is **WAN1** in this example.
  - 4) Set **Server IP Address/Domain Name**, which is **202.105.11.22** in this example.
  - 5) Set **User Name and Password**, which both are **Subsidiary1** in this example.
  - 6) Enable the **Encryption** function.
  - 7) Set **Remote LAN**, which is **192.168.0.0** in this example.
  - 8) Set **Remote Subnet Mask**, which is **255 255.255.0** in this example.
  - 9) Click **Save**.



**VPN Client**

VPN Client  Enable  Disable

Client Type  PPTP  L2TP

WAN Port

Server IP Address/Domain Name

User Name

Password

Encryption  Enable  Disable

VPN Agent  Enable  Disable

Remote LAN

Remote Subnet Mask

Status **Disconnected**

----End

When the status of the page shows **Connected**, the VPN connection is successful.

Staff in the subsidiary and headquarters can securely access each other's LAN resources through the internet.

## Verification

Assume that the subsidiary is about to access the FTP server of the headquarters. The headquarters project data is stored on an FTP server and the server information is as follows:

- FTP server IP address: 192.168.10.254
- FTP service port: 21
- Login user name/password: Tom123/Tom123

When the subsidiary staff access the headquarters project materials, perform the following procedure:

1. Enter **ftp://server IP address** in a browser or **This PC**, which is **ftp://192.168.10.254** in this example.



If the LAN service port is not the default port number, the access format is **LAN service application layer protocol name://Server IP address:LAN service port**.

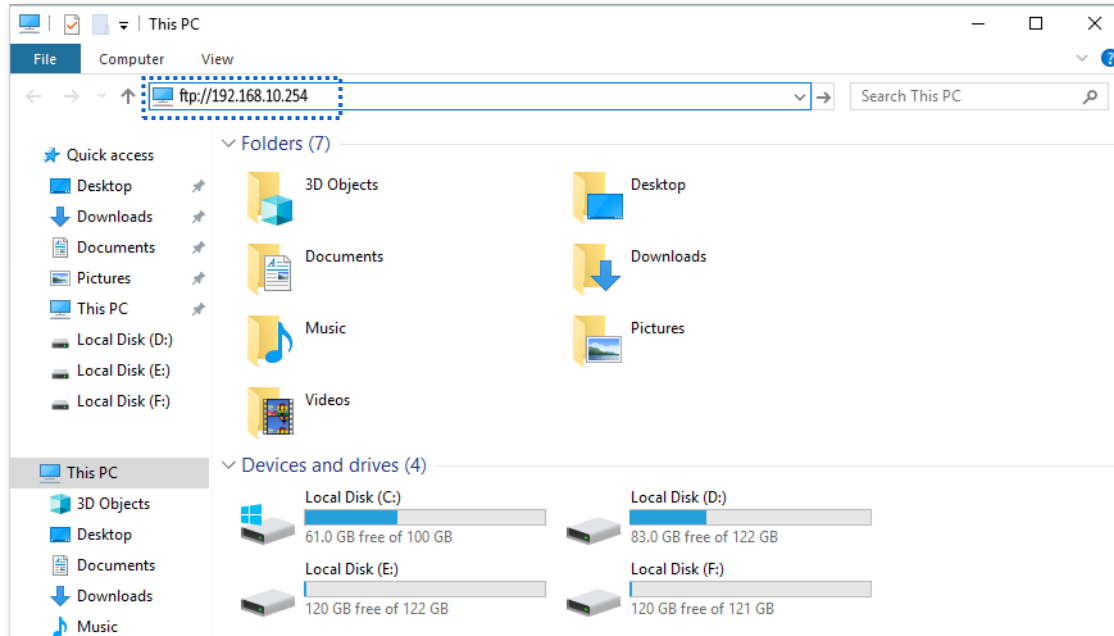

2. Enter the user name and password, which are both **Tom123** in this example, and click **Login**.

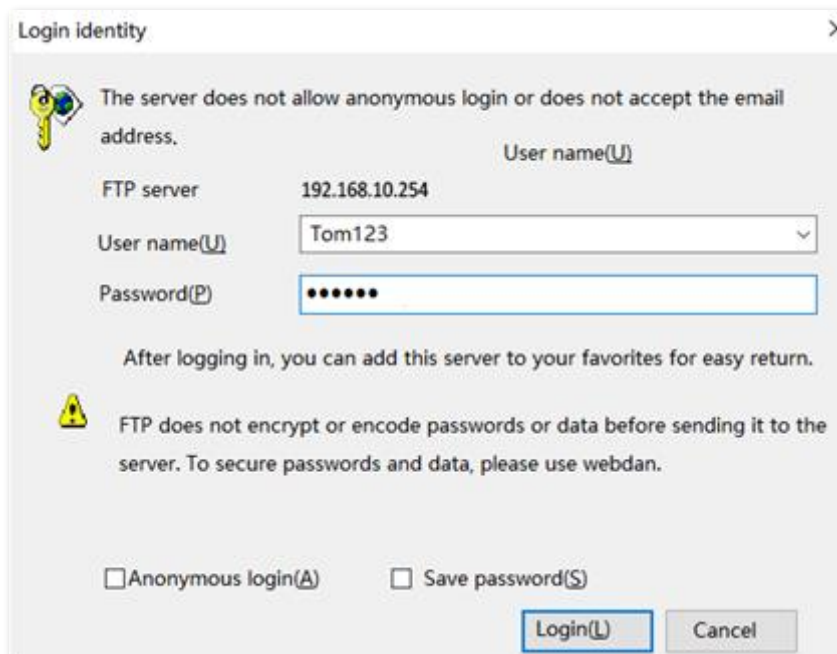

----End

The access is successful. See the following figure.

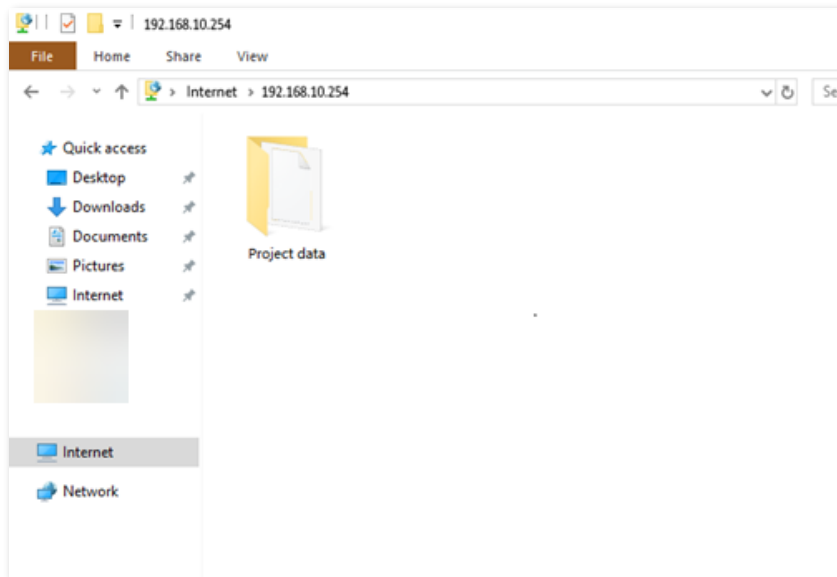

## 10.4.4 Example of configuring an L2TP over IPsec VPN

### Networking requirements

An enterprise uses the enterprise router to set up a network and successfully access the internet. The staff on business trip need to access intranet resources through the internet, such as internal documents, office OA, ERP system, CRM system, project management system and so on.

### Solution

Configure an L2TP server on the router, and enable IPsec to encrypt data packets, so that remote users can securely access the intranet through the internet.

Assume that the basic information of the L2TP server is as follows:

- The user name and password assigned by the L2TP server are both **Tom123**.
- The L2TP server IP address is **202.105.11.22**.
- L2TP server enables encryption of data.
- The intranet of the L2TP server is **192.168.10.0/24**.
- The port through which the L2TP server establishes the VPN tunnel is **WAN1**.

Assume that when the L2TP server establishes a connection with the L2TP client, the pre-shared key used to authenticate the identity is **JohnDoe123**.

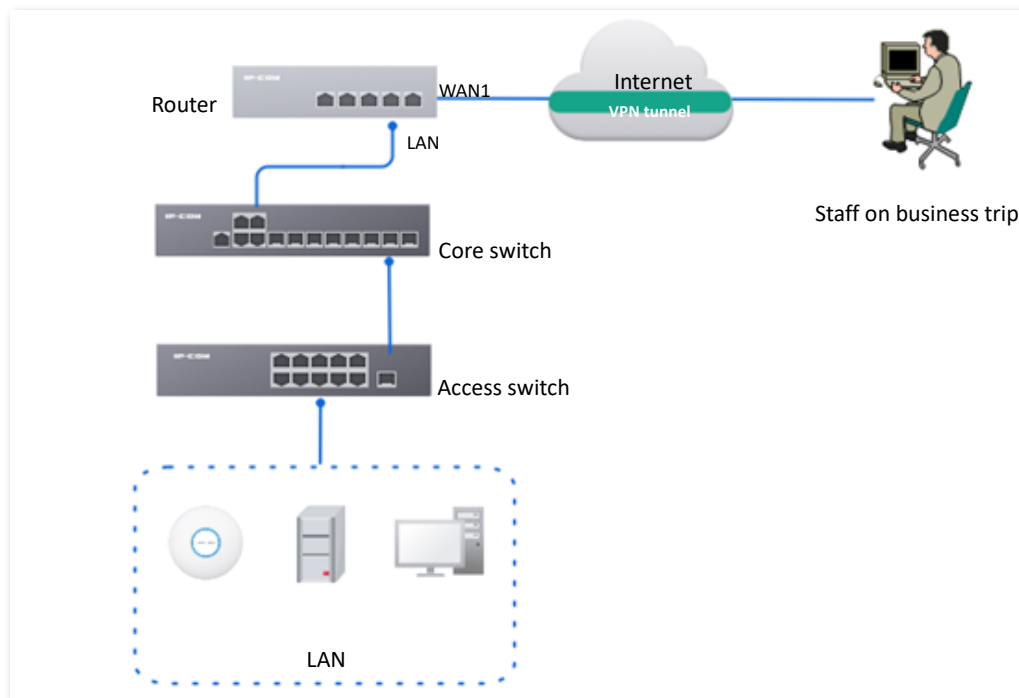

## Configuration procedure

Configure the L2TP server

Configure the L2TP user

1. [Log in to the web UI of the router.](#)
2. Configure the L2TP server.

The following table shows the examples of L2TP server parameters.

Server Name	VPN Type	Ingress and Egress	Encryption	Pre-shared Key	Client Address Pool
L2TP Server	L2TP	WAN1	Encrypted	JohnDoe123	10.1.0.100–10.1.0.163

Navigate to **More > VPN Service > VPN Server**. Click **Add** to configure L2TP server-related parameters, and click **Save**.



The **Encryption** is set to **Encrypted**, which means the L2TP server uses the IPsec to encrypt.

3. Configure the L2TP user.

The following table shows the examples of L2TP user parameters.

VPN Type	User Name	Password	User Group	Client Type
L2TP	Tom123	Tom123	Staff on Business Trip	Terminal

1) Configure VPN user group.

Navigate to **Audit > Group Policy > User Group**, click **Add** to configure VPN user group for VPN client, and click **Save**.

2) Configure the L2TP user.

Navigate to **More > VPN Service > User Management**. Click **Add** to configure the relevant parameters of the L2TP user, and click **Save**.

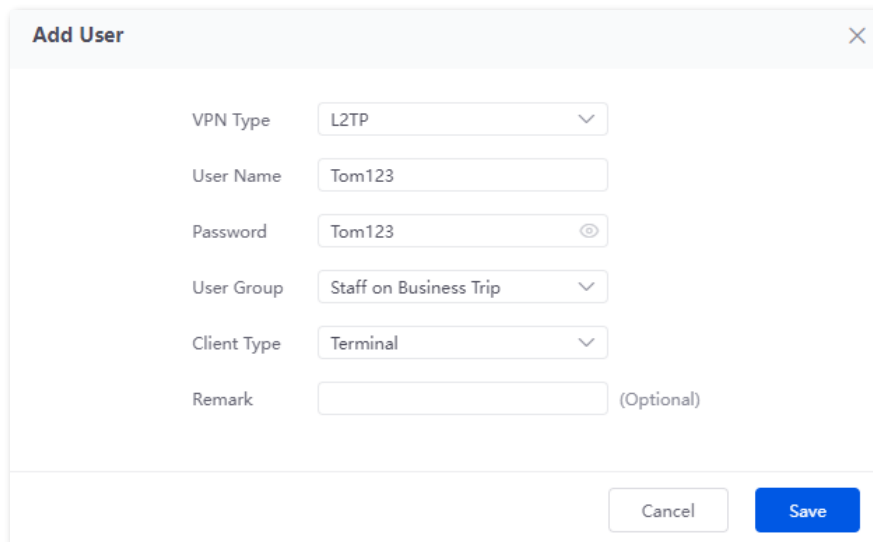

----End

## Verification

Staff on business trip use VPN dial-up to access headquarters resources.

**Scenario 1: Staff on business trip access headquarters resources on a computer (Example: Windows 10).**

### I. Staff creating VPN connection on business trip

1. Click  in the lower right corner of the desktop, click **Network & Internet settings**.

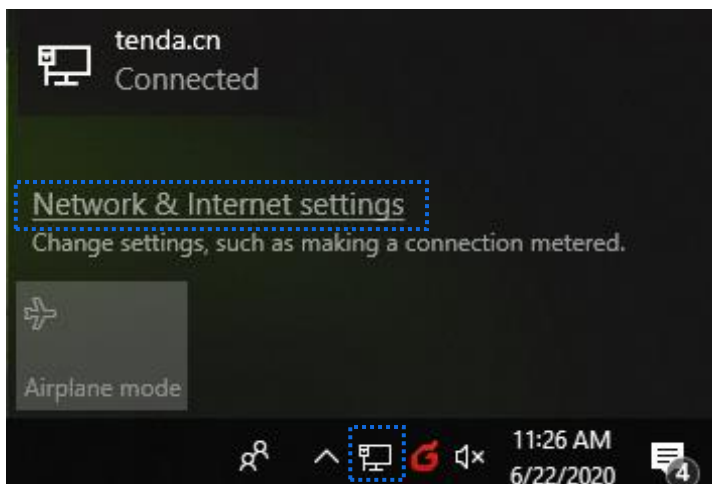

2. Click **VPN** and then **Add a VPN connection**.

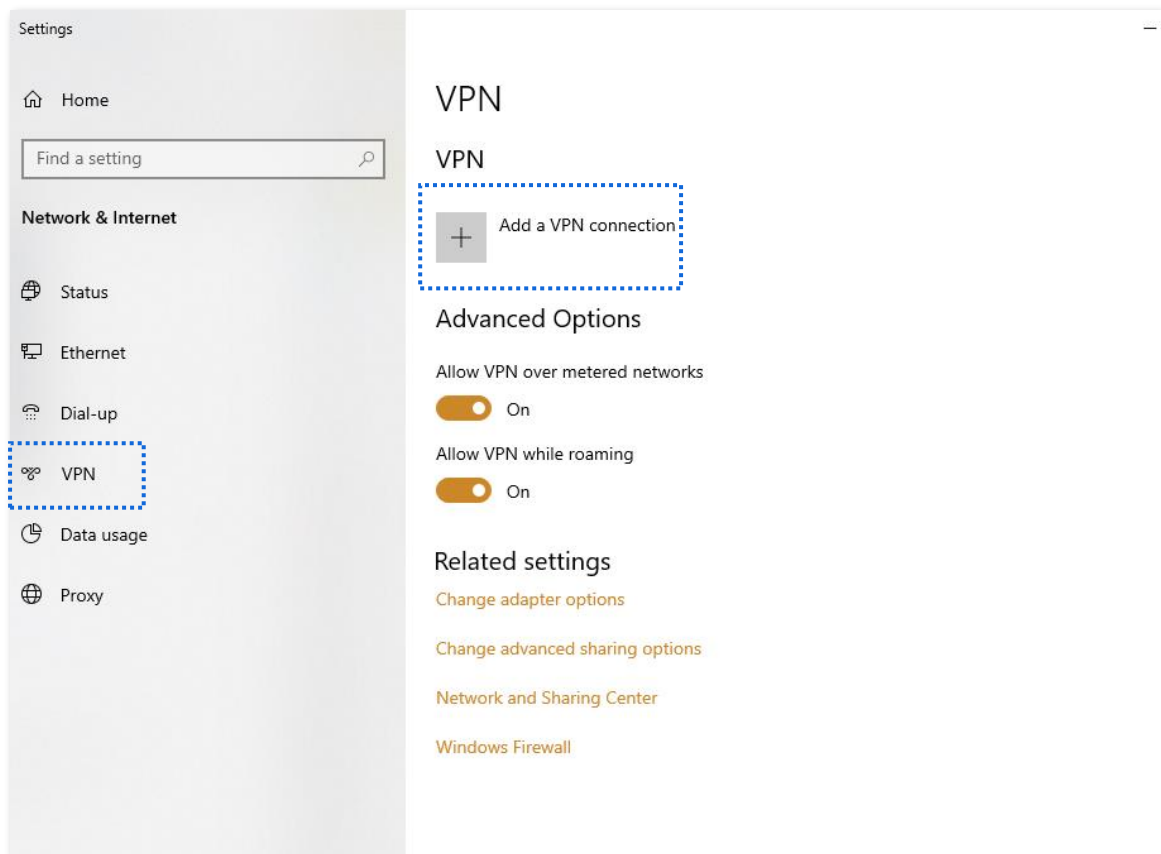

3. Set VPN connection parameters, and then click **Save**.
  - 1) Select **VPN provider**, which is **Windows (built-in)** in this example.
  - 2) Set the **Connection name** of VPN, which is **VPN Access** in this example.
  - 3) Set **Server name or address**, which is **202.105.11.22** in this example.
  - 4) Select **VPN type**, which is **L2TP/IPsec with pre-shared key** in this example.
  - 5) Set **Pre-shared key** of the IPsec tunnel, which is **JohnDoe123** in this example.
  - 6) Pull down the scroll bar, select **Type of sign-in info**, which is **User name and password** in this example.
  - 7) Set **User name** and **Password**, which are both **Tom123** in this example.

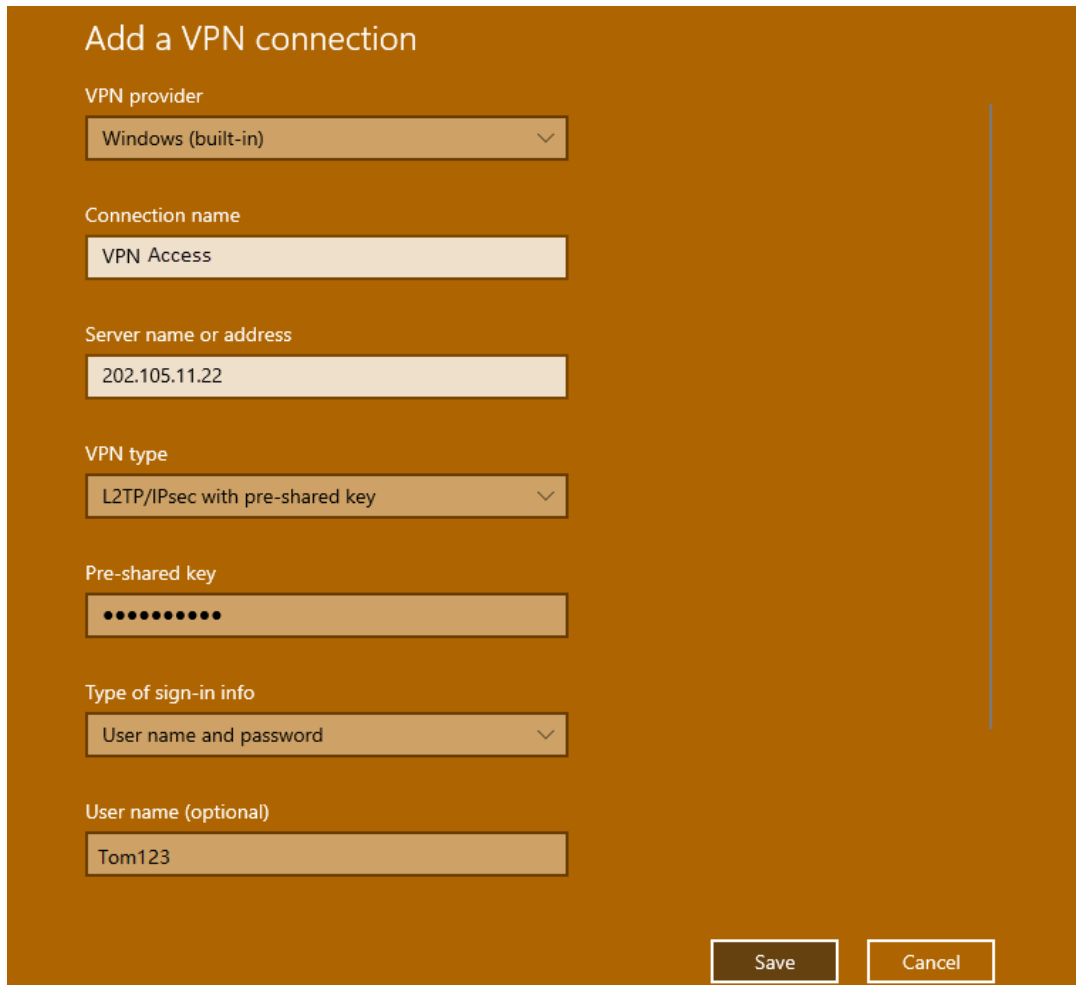

4. Click **VPN Access**, then click **Connect**.

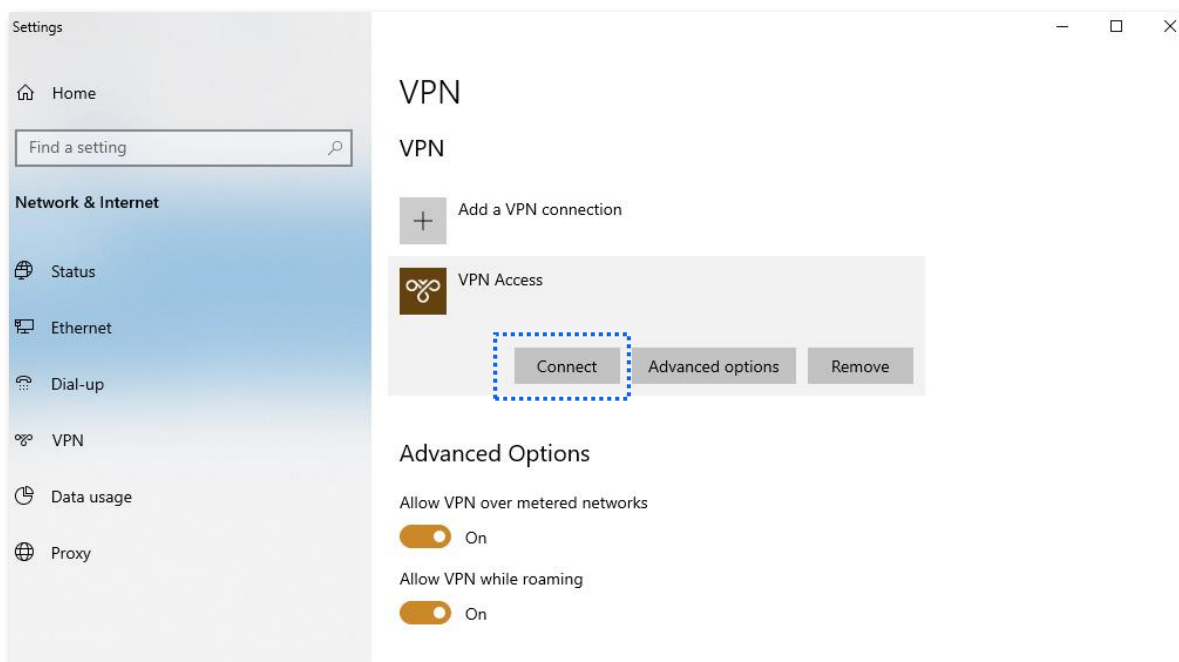



Wait until a connection is established, which can access VPN according to the account information provided by the headquarters.

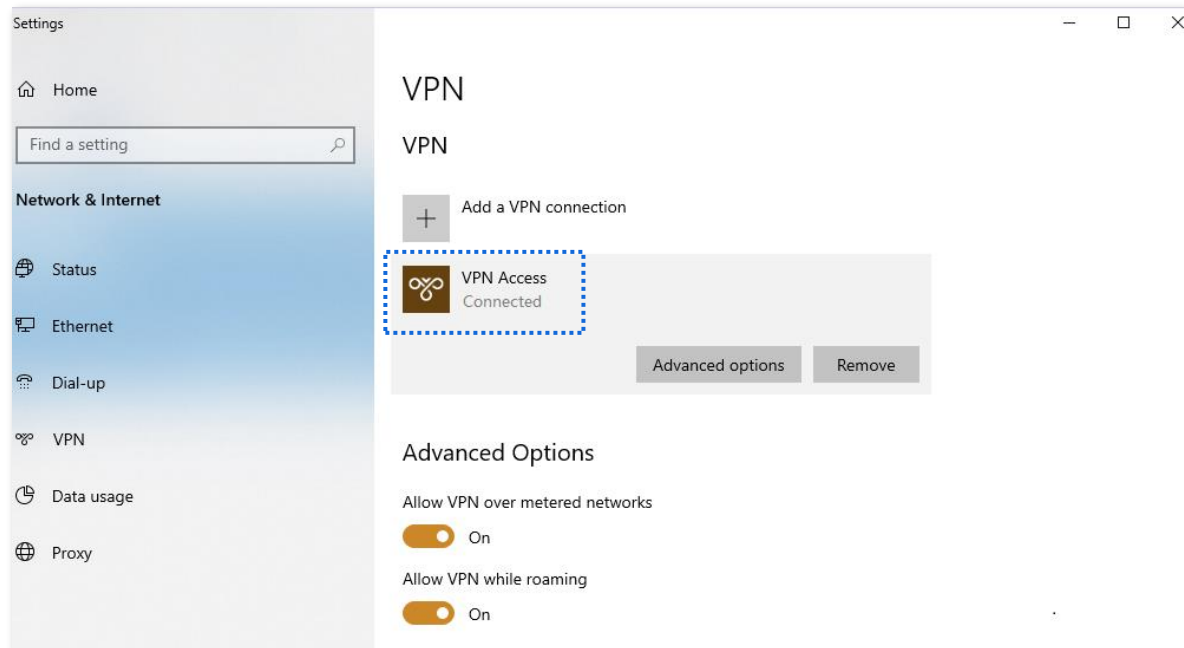

## II. Staff accessing headquarters resources on business trip

Assume that the staff on business trip need to access the FTP server of headquarters. The server information is as follows:

- FTP server IP address: 192.168.10.254
- FTP service port: 21
- Login user name/password: Tom123/Tom123

When the staff on business trip access the headquarters project materials, perform the following procedures:

1. Enter **ftp://server IP address** in a browser or **This PC**, which is **ftp://192.168.10.254** in this example.



If the LAN service port is not the default port number, the access format is **LAN service application layer protocol name://Server IP address:LAN service port**.

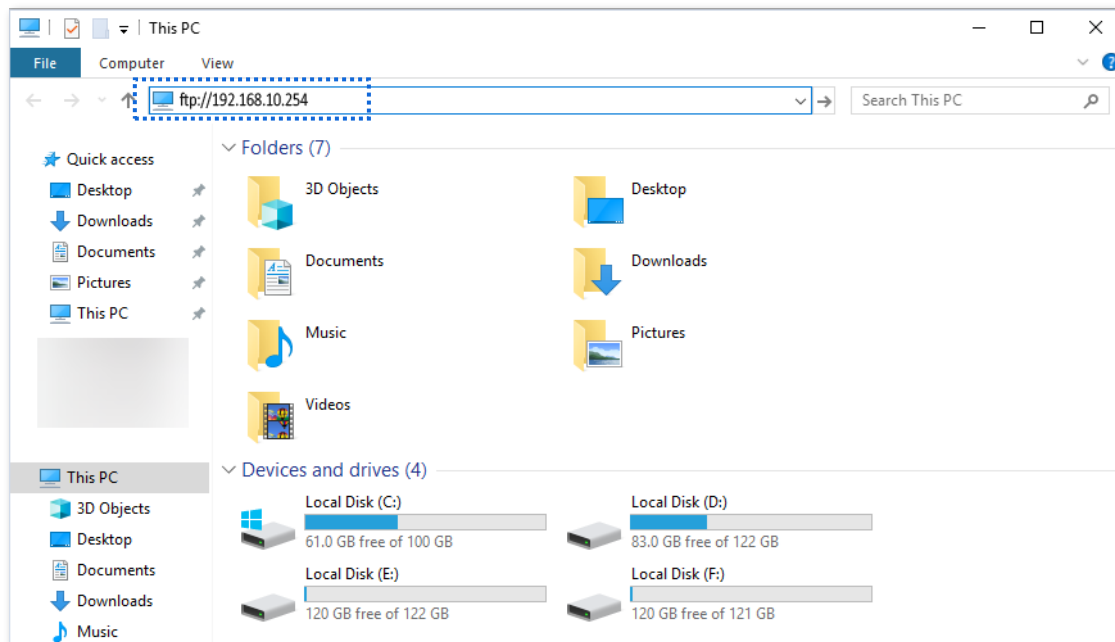

2. Enter the user name and password, which are both **Tom123** in this example, and click **Login**.

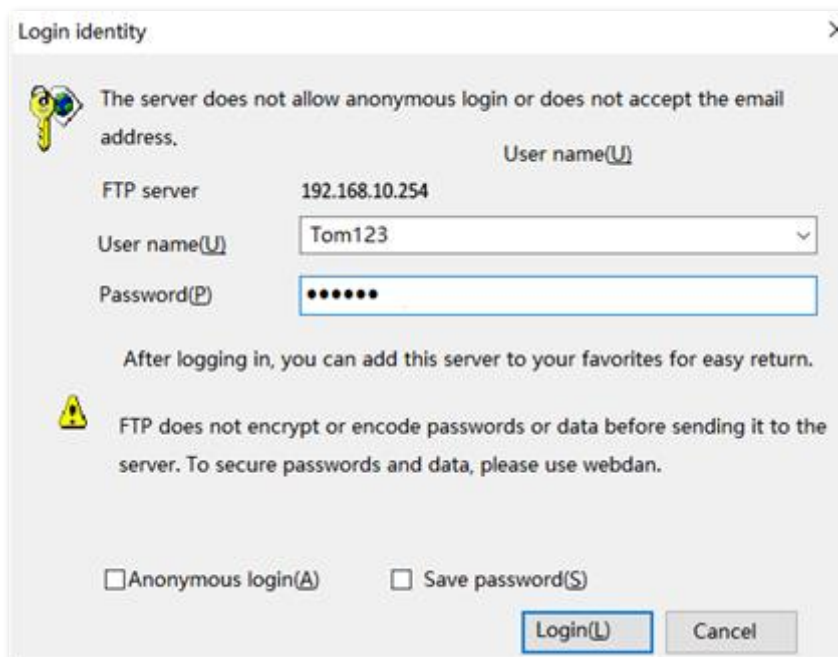

The access is successful. See the following figure.

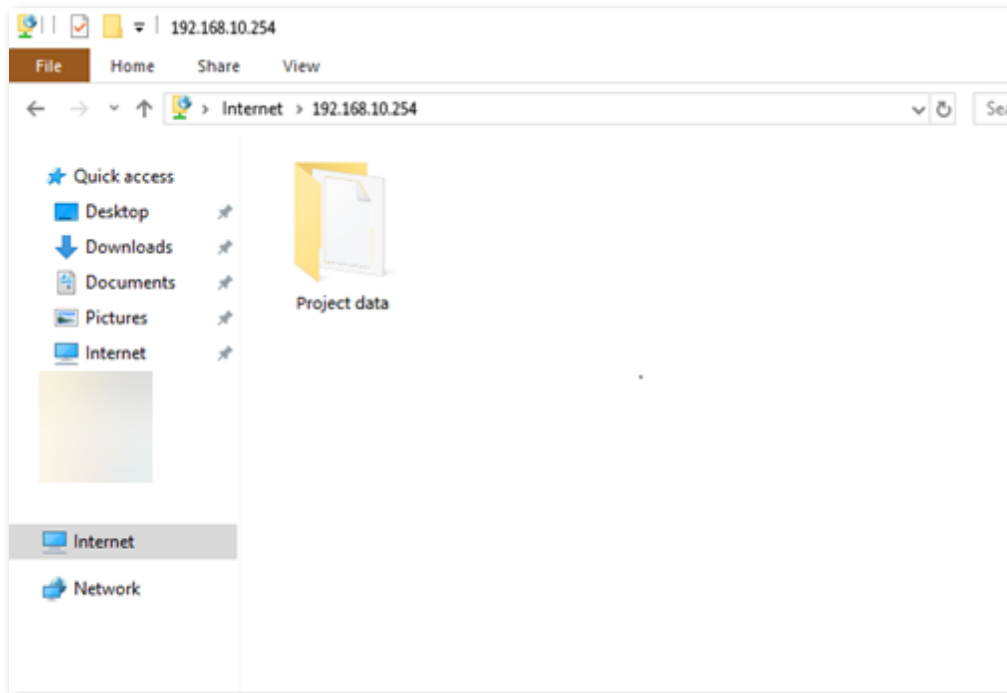

## Scenario 2: Staff on business trip access headquarters resources on mobile devices (Example: iOS system)

### I. Staff creating VPN connection on business trip

1. Click  (Settings) on your smartphone.
2. Tap **VPN**.



3. Tap **Add VPN Configuration...**

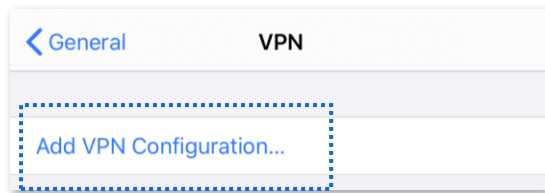

4. Set the VPN connection parameters.

- 1) Select the **Type**, which is **L2TP** in this example.
- 2) Set the name of VPN connection in **Description**, which is **HQ** in this example.
- 3) Set **Server** (the IP address of L2TP server), which is **202.105.11.22** in this example.
- 4) Set **Account** and **Password** of L2TP VPN, which are both **Tom123** in this example.
- 5) Set **Secret** of IPsec tunnel, which is **JohnDoe123** in this example.
- 6) Tap **Done**.

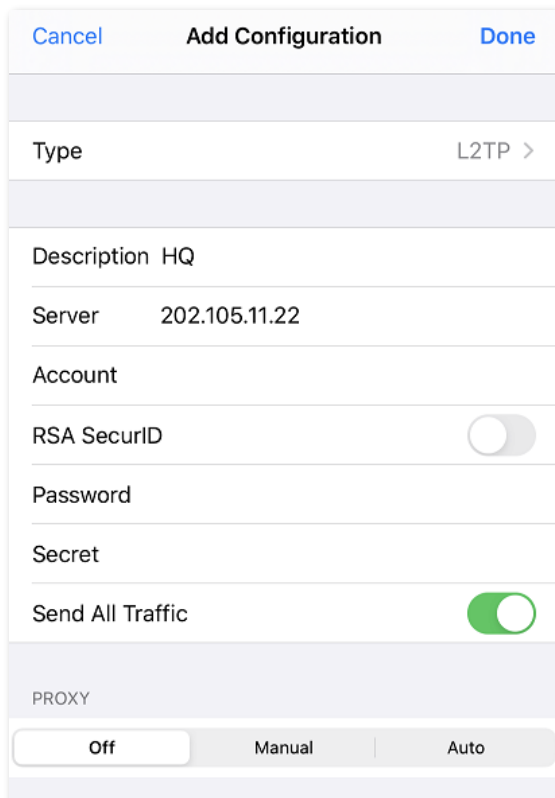

5. Tap .

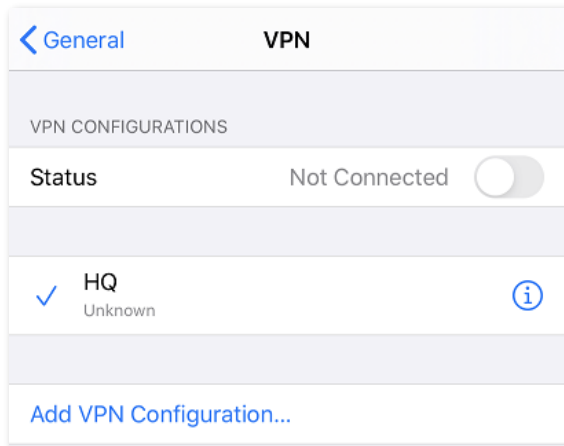

Wait until the **Status** turns to **Connected** , the IPSec connection is created successfully.

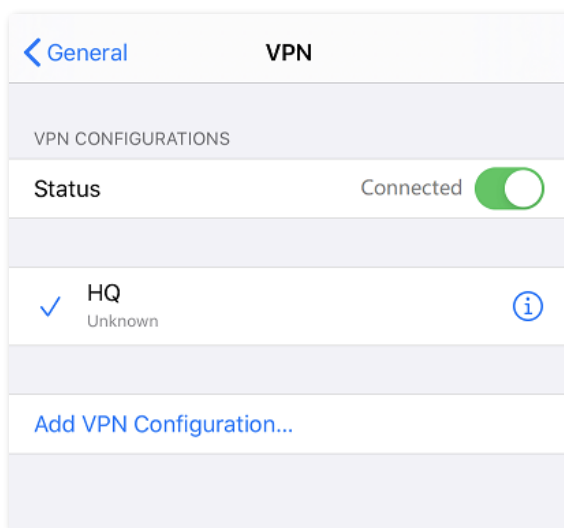

## II. Staff accessing headquarters resources on business trip

If you want to use the mobile device (such as smartphone and tablet) to access the FTP server, you should install an FTP client on your mobile device first.

## 10.4.5 IPsec

### Overview

IP Security (IPsec) is a protocol suite for transmitting data over the internet in a secure and encrypted manner.

#### ■ Encapsulation mode

The Encapsulation mode specifies the encapsulation mode of the data transmitted by IPsec. IPsec supports **Tunnel** and **Transport** modes.

- **Tunnel Mode:** This mode adds an additional IP head and is most commonly used between gateways. The whole IP data packet of the user is used to calculate the Authentication Header (AH) or Encapsulating Security Payload (ESP) head. The AH or ESP head and the user data encrypted by ESP are encapsulated in a new IP data packet.
- **Transport Mode:** This mode does not change the original IP head and is most commonly used between hosts. Only the data at the transmission layer is used to calculate the AH or ESP head. The AH or ESP head or the user data encrypted by ESP are placed behind the original IP packet head.

Mode Protocol	Tunnel Mode	Transport Mode
AH	IP   AH   Data	IP   AH   IP   Data
ESP	IP   ESP   Data   ESP-T	IP   ESP   IP   Data   ESP-T
AH +ESP	IP   AH   ESP   Data   ESP-T	IP   AH   ESP   IP   Data   ESP-T

#### ■ Security gateway

It refers to a gateway (secure and encrypted router) with the IPsec functionality. IPsec is used to protect data exchanged between such gateways from being tampered and peeped.

#### ■ IPsec peer

The two IPsec clients are called IPsec peers. The two peers (security gateways) can securely exchange data only after a Security Association (SA) is set up between them.

#### ■ SA

SA specifies some elements of the peers, such as the base protocol (AH, ESP or both), encapsulation mode (transport or tunnel), encryption algorithm (DES, 3DES or AES), shared key for data protection in specified flows and life cycle of the key.

SA has the following features:

- A triplet {SPI, Destination IP address, Security protocol identifier} is used as a unique ID.
- An SA specifies the protocol, algorithm and key for processing packets.
- An SA is unidirectional. At least two SAs are needed to protect data flows in bidirectional communication. If two peers want to use both AH and ESP to protect data flows between them, each peer will construct an independent SA for each protocol.
- An SA can be created manually or generated automatically using Internet Key Exchange (IKE).
  - Manually: The configuration is complex. All the information required to create an SA must be manually configured, and some advanced features (such as regular key update) are not supported. At this time, the SA has no life cycle limit and never expires unless it is manually deleted, which has certain security risks. Typically used in small and static environments, or when the number of peer devices communicating is less.
  - IKE Auto-Negotiation: Simple configuration, which you only need to configure the information of IKE negotiation security policy, and IKE Auto-Negotiation will create and maintain the SA. At this time, the SA has a life cycle and will be updated regularly to enhance security. Generally used in medium and large dynamic network environments.

## ■ Ways to create SA

### Manually

Manually configure all the information required by the SA, including authentication algorithm, authentication key, encryption algorithm, encryption key, SPI value and so on.

### IKE Auto-Negotiation

During the auto-negotiation, to ensure the privacy of information, both parties to the IPsec communication need to use information known to each other to encrypt and decrypt the data, so the two parties need to negotiate the security key at the beginning of the communication, and this process is completed by IKE.

IKE is a hybrid of ISAKMP, Oakley and SKEME protocols.

- ISAKMP: Internet Security Association and Key Management Protocol (ISAKMP) provides a framework for exchanging keys and SA negotiation.
- Oakley: Oakley Key Determination Protocol is a key-agreement protocol that describes the specific mechanism for key exchange.
- SKEME: Secure Key Exchange Mechanism (SKEME) describes another key exchange mechanism that differs from Oakley.

IKE negotiation process is divided into two phases:

## ■ Phase 1

The communicating parties will negotiate and exchange security proposals such as authentication algorithms and encryption algorithms, and establish an ISAKMP SA for the secure exchange of more information in Phase 2.

The specific completion process is as follows:

- 1) Negotiate and confirm a series of algorithms and other security proposals to ensure that both peers use the same security proposals.
- 2) Calculate the Diffie-Hellman (DH) public value based on the pre-shared key and the negotiated security proposal for key exchange.
- 3) Peer verification. The router verifies the legitimacy of the peer through the pre-shared key.

## ■ Phase 2

This stage mainly negotiates a specific SA for IPsec on the ISAKMP SA established in Phase 1, and establishes an IPsec SA for the secure transmission of IP data.

## Configure IPsec-tunnel mode

[Log in to the web UI of the router](#), and navigate to **More > VPN Service > IPsec** to enter the page. On this page, you can configure the IPsec policy.

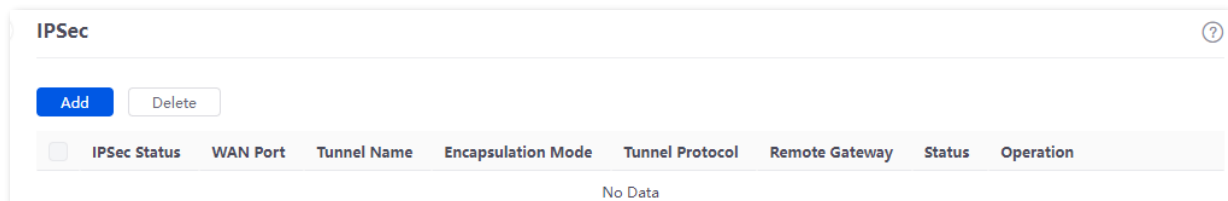



You can click **Add** to add a new IPsec policy.

IPsec data encapsulation mode includes Tunnel Mode and Transport Mode. It is tunnel mode by default.



### Parameter description

Parameter	Description
IPsec	Used to enable or disable the IPsec function.
WAN Port	Specifies the local WAN port assigned to the IPsec function. The IP address of the WAN port must be set as the value of remote gateway of the IPsec peer.
Encapsulation Mode	<p>Specifies the encapsulation mode of IPsec data.</p> <ul style="list-style-type: none"> <li><b>Tunnel:</b> Used to protect the whole IP data packet (including IP head and data load), usually used for secure communication between two gateways.</li> <li><b>Transport:</b> Used to protect data load of the IP data packet, but not the IP head. This mode is generally used for secure communication between hosts and hosts or between hosts and gateways.</li> </ul>

Parameter	Description
Tunnel Name	Specifies the name of the IPSec tunnel.
Exchange Mode	<p>Specifies the negotiation mode of the IPSec tunnel.</p> <ul style="list-style-type: none"> <li>- <b>Initiator Mode:</b> The router initiates connection proactively and asks for access to the peer gateway.</li> <li>- <b>Responder Mode:</b> The router waits for the connection request.</li> </ul> <p> <b>Note</b></p> <p>Do not set both sides of the IPSec tunnel to <b>Responder Mode</b>. Otherwise, you will fail to establish the IPSec tunnel.</p>
Tunnel Protocol	<p>Specifies the protocol which offers the security service for IPSec.</p> <ul style="list-style-type: none"> <li>- <b>AH:</b> It is abbreviated for Authentication Header. This protocol is used for verifying data integrity. If a packet is tampered during transmission, the receiver discards it during data integrity verification.</li> <li>- <b>ESP:</b> It is abbreviated for Encapsulating Security Payload. This protocol is used for verifying data integrity and encrypting data. If a packet processed using this protocol is intercepted during transmission, it is difficult for the intercepting party to obtain the real information contained in the packet. This compatible protocol is widely used in gateway products.</li> <li>- <b>AH+ESP:</b> Use both of the above protocols simultaneously.</li> </ul>
Remote Gateway	<p>Specifies the WAN port IP address or domain name set by the IPSec tunnel peer gateway.</p> <p> <b>Note</b></p> <p>When it is set to a domain name, the DDNS function has to be configured in the remote gateway to ensure that the use of IPSec tunnel is not affected by the changeable WAN port IP address of the remote gateway.</p>
Local LAN/Mask	Specifies the network segment and subnet mask of LAN network of the router. For example: Assume that the LAN IP address and subnet mask of this router are 192.168.0.1 and 255.255.255.0 respectively, enter 192.168.0.0/24.
Remote LAN/Mask	Specifies the LAN network segment and subnet mask of the remote gateway of the IPSec tunnel. If the remote gateway is a single host, enter its IP address/32.

Parameter	Description
Key Negotiation	<p>The key negotiation method to establish an IPSec tunnel. The default mode is <b>Auto Negotiation</b>.</p> <ul style="list-style-type: none"><li>– <b>Auto Negotiation:</b> It indicates that an SA is set up, maintained, and deleted automatically using IKE (Internet Key Exchange). This reduces configuration complexity and simplifies IPSec usage and management. Such an SA (Security Association) has a life cycle and is updated regularly, leading to higher security.</li><li>– <b>Manual:</b> It indicates that an SA is set up by manually specifying encryption and authentication algorithms and keys. Such an SA does not have a life cycle, and therefore it remains valid unless being manually deleted, leading to security risks. Generally, this mode is used only for commissioning.</li></ul>

### Key negotiation-auto negotiation

During the auto-negotiation, to ensure the privacy of information, both parties to the IPSec communication need to use information known to each other to encrypt and decrypt the data, so the two parties need to negotiate the security key at the beginning of the communication, and this process is completed by IKE.

IKE is a hybrid of ISAKMP, Oakley and SKEME protocols.

- ISAKMP: Internet Security Association and Key Management Protocol (ISAKMP) provides a framework for exchanging keys and SA negotiation.
- Oakley: Oakley Key Determination Protocol is a key-agreement protocol that describes the specific mechanism for key exchange.
- SKEME: Secure Key Exchange Mechanism (SKEME) describes another key exchange mechanism that differs from Oakley.

IKE negotiation process is divided into two phases:

#### ■ Phase 1

The communicating parties will negotiate and exchange security proposals such as authentication algorithms and encryption algorithms, and establish an ISAKMP SA for the secure exchange of more information in Phase 2.

#### ■ Phase 2

This stage mainly negotiates a specific SA for IPSec on the ISAKMP SA established in Phase 1, and establishes an IPSec SA for the secure transmission of IP data.

When **Key Negotiation** is set to **Auto Negotiation**, the following figure is for reference only.

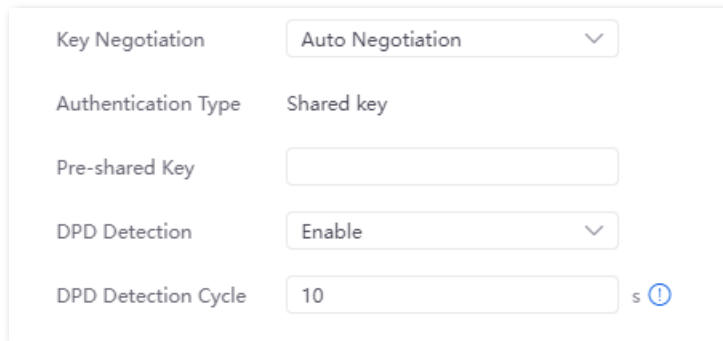

The screenshot shows a configuration panel with the following settings:

- Key Negotiation: Auto Negotiation (dropdown)
- Authentication Type: Shared key
- Pre-shared Key: (empty text field)
- DPD Detection: Enable (dropdown)
- DPD Detection Cycle: 10 (text field) s ⓘ

### Parameter description

Parameter	Description
Authentication Type	When <b>Shared key</b> is displayed on the page, it indicates that IPsec peers negotiated a key string shared between them.
Pre-shared Key	Specifies the pre-shared key used for negotiation. The key consists of a maximum of 128 characters and must be the same as that specified on the peer gateway.
DPD Detection	Used to enable or disable the Dead Peer Detection (DPD) function. When the DPD function is enabled, the router will periodically send DPD packets to the remote tunnel site to confirm whether the remote site is valid.
DPD Detection Cycle	Specifies the interval at which the router sends DPD frames. The default value is 10. If the router does not receive the confirmation of DPD frames within the valid period, it will initialize the IPsec SA from the local to the remote device.

Click **Advanced** to display the advanced parameters of auto negotiation.

Period 1

Mode Main

Encryption Algorithm DES

Integrity Verification SHA1

Diffie-Hellman Group 768

Local ID Type IP Address

Peer ID Type IP Address

Key Expiration 3600

Period 2

PFS  Enable  Disable

Encryption Algorithm DES



Integrity Verification SHA1

Diffie-Hellman Group 768

Key Expiration 3600

### Parameter description

Parameter	Description
Mode	<p>Specifies the mode supported by IKEv1. The mode selected should be consistent with that of the peer device. By default, <b>Main Mode</b> is selected.</p> <ul style="list-style-type: none"> <li>- <b>Main Mode:</b> Under this mode, packet exchanges are frequent and identity protection is provided. Therefore, this mode is applicable for scenarios that require high level of identity protection.</li> <li>- <b>Aggressive Mode:</b> Under this mode, identity protection is not provided and packet exchanges are less with high negotiation speed. Therefore, this mode is applicable for scenarios that require low level of identity protection.</li> </ul>
Encryption Algorithm	<p>Specifies the IKE session encryption algorithm.</p> <ul style="list-style-type: none"> <li>- <b>DES:</b> It is abbreviated for Data Encryption Standard. A 56-bit key is used to encrypt 64-bit data. The last 8 bits of the 64-bit data are used for parity check. 3DES indicates that three 56-bit keys are used for encryption.</li> <li>- <b>AES:</b> It is abbreviated for Advanced Encryption Standard. AES 128/192/256 indicates that 128/192/256-bit keys are used for encryption respectively.</li> </ul>

Parameter	Description
Integrity Verification	<p>Specifies the IKE session verification algorithm.</p> <ul style="list-style-type: none"> <li>– <b>MD5:</b> It is abbreviated for Message Digest Algorithm. A 128-bit message digest is generated to prevent message tampering.</li> <li>– <b>SHA1:</b> It is abbreviated for Secure Hash Algorithm. A 160-bit message digest is generated to prevent message tampering, leading to higher security than MD5.</li> </ul>
Diffie-Hellman Group	<p>Specifies the group information for the Diffie-Hellman algorithm for generating a session key used to encrypt an IKE tunnel. The information should be the same as that of the remote gateway.</p>
Local ID Type	<p>Specifies the ID of local gateway.</p> <ul style="list-style-type: none"> <li>– <b>IP Address:</b> Local router uses the WAN IP address of the remote gateway for negotiation with it.</li> <li>– <b>FQDN:</b> It is abbreviated for Fully Qualified Domain Name. You have to manually set a string of characters in the <b>Local ID</b>. Local ID should be identical with the peer ID of the remote gateway.</li> </ul> <p> <b>Note</b></p> <p>Local ID type should be identical with the peer ID type. And you are recommended to modify the <b>Mode</b> to <b>Aggressive</b> in this case.</p>
Peer ID Type	<p>Specifies the ID of peer gateway.</p> <ul style="list-style-type: none"> <li>– <b>IP Address:</b> The router uses the IP address of the specified WAN port for negotiation with the remote gateway.</li> <li>– <b>FQDN:</b> It is abbreviated for Fully Qualified Domain Name. You have to manually set a string of characters in the <b>Peer ID</b>. Peer ID should be identical with the local ID of the remote gateway.</li> </ul> <p> <b>Note</b></p> <p>Local ID type should be identical with the peer ID type. And you are recommended to modify the <b>Mode</b> to <b>Aggressive</b> in this case.</p>
Key Expiration	<p>Specifies the survival time of IPSec SA.</p>
PFS	<p>Specifies the Perfect Forward Secrecy (PFS) property of the IPSec session key. The PFS property must be consistent with the local PFS property.</p> <ul style="list-style-type: none"> <li>– <b>Enable PFS:</b> Phase 2 negotiates to generate a new key material that is not associated with the key material negotiated by Phase 1, even if the IKE1 Phase 1 key is cracked, the Phase 2 key remains secure.</li> <li>– <b>Disable PFS:</b> The key of Phase 2 will be generated according to the key material generated by Phase 1. Once the key of Phase 1 is cracked, the Phase 2 key used to protect the communication data is also at risk, which will seriously threaten the communication security of both parties.</li> </ul>

## Key negotiation-manual

When **Key Negotiation** is set to **Manual**, the following figure is for reference only. (AH+ESP tunnel protocol used as example)

Key Negotiation	Manual
ESP Encryption Algorithm	DES
ESP Encryption Key	<input type="text"/>
ESP Authentication Algorithm	MD5
ESP Authentication Key	<input type="text"/>
ESP Outgoing SPI	<input type="text"/>
ESP Incoming SPI	<input type="text"/>
AH Authentication Algorithm	MD5
AH Authentication Key	<input type="text"/>
AH Outgoing SPI	<input type="text"/>
AH Incoming SPI	<input type="text"/>

## Parameter description

Parameter	Description
ESP Encryption Algorithm	<p>When the Tunnel Protocol is set to ESP, the ESP encryption algorithm is required. The router supports the following algorithms:</p> <ul style="list-style-type: none"> <li>- <b>DES</b>: A 56-bit key is used to encrypt 64-bit data. The last 8 bits of the 64-bit data are used for parity check. 3DES indicates that three 56-bit keys are used for encryption.</li> <li>- <b>AES</b>: A 128/192/256-bit key is used for encryption. AES 128/192/256 indicates that 128/192/256-bit keys are used for encryption respectively.</li> </ul>
ESP Encryption Key	Used to set the ESP encryption key. Both IPsec communication parties should have the same key.
ESP/AH Authentication Algorithm	<p>When the <b>Tunnel Protocol</b> is set to <b>ESP</b> or <b>AH</b>, the corresponding encryption algorithm is required. The router supports the following algorithms:</p> <ul style="list-style-type: none"> <li>- <b>MD5</b>: A 128-bit message digest is generated to prevent message tampering.</li> <li>- <b>SHA1</b>: A 160-bit message digest is generated to prevent message tampering.</li> </ul>
ESP/AH Authentication Key	When the <b>Tunnel Protocol</b> is set to <b>ESP</b> or <b>AH</b> , the corresponding authentication key is required. Both IPsec communication parties should have the same key.

Parameter	Description
ESP/AH Outgoing SPI	<p>SPI (Security Parameter Index) is used to identify an IPSec SA with the IP address and security protocol of the remote gateway.</p> <ul style="list-style-type: none"> <li>- <b>ESP Outgoing SPI:</b> Keep this value same as the ESP incoming SPI value of the remote gateway.</li> </ul>
ESP/AH Incoming SPI	<ul style="list-style-type: none"> <li>- <b>ESP Incoming SPI:</b> Keep this value same as the ESP outgoing SPI value of the remote gateway.</li> <li>- <b>AH Outgoing SPI:</b> Keep this value same as the AH incoming SPI value of the remote gateway.</li> <li>- <b>AH Incoming SPI:</b> Keep this value same as the AH outgoing SPI value of the remote gateway.</li> </ul>

## Configure IPSec-transport mode

[Log in to the web UI of the router](#), and navigate to **More > VPN Service > IPSec** to enter the page. Click **Add**, select **Transport** for **Encapsulation Mode** on the **Add IPSec** pop-up window, configure other parameters as required, and click **Save**.

### Parameter description

Parameter	Description
IPSec	Used to enable or disable the IPSec function.
WAN Port	Specifies the local WAN port assigned to the IPSec function. The IP address of the WAN port must be set as the value of remote gateway of the IPSec peer.



Parameter	Description
Encapsulation Mode	<p>Specifies the encapsulation mode of IPSec data.</p> <ul style="list-style-type: none"><li>– <b>Tunnel:</b> Used to protect the whole IP data packet (including IP head and data load), usually used for secure communication between two gateways.</li><li>– <b>Transport:</b> Used to protect data load of the IP data packet, but not the IP head. This mode is generally used for secure communication between hosts and hosts or between hosts and gateways.</li></ul>
Tunnel Name	<p>Specifies the name of the IPSec tunnel.</p>
Exchange Mode	<p>Specifies the negotiation mode of the IPSec tunnel.</p> <ul style="list-style-type: none"><li>– <b>Initiator Mode:</b> The router initiates connection proactively and asks for access to the peer gateway.</li><li>– <b>Responder Mode:</b> The router waits for the connection request.</li></ul> <p> <b>Note</b></p> <p>Do not set both sides of the IPSec tunnel to <b>Responder Mode</b>. Otherwise, you will fail to establish the IPSec tunnel.</p>
Encryption Algorithm	<p>Specifies the IKE session encryption algorithm. The router supports the following algorithms:</p> <ul style="list-style-type: none"><li>– <b>DES:</b> A 56-bit key is used to encrypt 64-bit data. The last 8 bits of the 64-bit data are used for parity check. 3DES indicates that three 56-bit keys are used for encryption.</li><li>– <b>AES:</b> A 128/192/256-bit key is used for encryption. AES 128/192/256 indicates that 128/192/256-bit keys are used for encryption respectively.</li></ul>
Integrity Verification	<p>Specifies the IKE session verification algorithm.</p> <ul style="list-style-type: none"><li>– <b>MD5:</b> It is abbreviated for Message Digest Algorithm. A 128-bit message digest is generated to prevent message tampering.</li><li>– <b>SHA1:</b> It is abbreviated for Secure Hash Algorithm. A 160-bit message digest is generated to prevent message tampering, leading to higher security than MD5.</li></ul>
Pre-shared Key	<p>Specifies the pre-shared key used for negotiation. The key consists of a maximum of 128 characters and must be the same as that specified on the peer gateway.</p>

## View IPSec list

[Log in to the web UI of the router](#), and navigate to **More > VPN Service > IPSec List** to enter the page.

After the devices at both ends of the IPSec tunnel are configured, you can view the IPSec SA in the IPSec list.

IPSec List								
Name	SPI	Direction	Tunnel ID	Data Flow	Protocol	AH Authentication	ESP Authentication	ESP Encryption
No Data								

### Parameter description

Parameter	Description
Name	Specifies the name of the IPSec tunnel policy.
SPI	Specifies the Security Parameter Index (SPI) of the current tunnel, which is obtained through automatic IKE negotiation.
Direction	Specifies the direction of the tunnel (in: flow in, out: flow out). Because IPSec rules are one-way, when an IPSec tunnel is successfully established, each tunnel will generate a pair of “in and out” IPSec rules with the same name.
Tunnel ID	Specifies the gateway addresses of two sides of the tunnel.
Data Flow	Specifies the subnet masks of two sides of the tunnel.
Protocol	<p>Specifies the protocol which offers the security service for IPSec.</p> <ul style="list-style-type: none"> <li>– <b>AH:</b> It is abbreviated for Authentication Header. This protocol is used for verifying data integrity. If a packet is tampered during transmission, the receiver discards it during data integrity verification.</li> <li>– <b>ESP:</b> It is abbreviated for Encapsulating Security Payload. This protocol is used for verifying data integrity and encrypting data. If a packet processed using this protocol is intercepted during transmission, it is difficult for the intercepting party to obtain the real information contained in the packet. This compatible protocol is widely used in gateway products.</li> </ul>
AH Authentication	Specifies the AH authentication algorithm used by the tunnel, which is determined by the proposal of the second phase of IKEv1.
ESP Authentication	Specifies the ESP authentication algorithm used by the tunnel, which is determined by the proposal of the second phase of IKEv1.
ESP Encryption	Specifies the ESP encryption algorithm used by the security protocol, which is determined by the security proposal in the second phase of IKEv1.

## 10.4.6 Example of configuring an IPSec VPN

### Networking requirements

The headquarters and subsidiary use enterprise-class routers to set up a network and successfully access the internet. The subsidiary staff need to access intranet resources through the internet, such as internal documents, office OA, ERP system, CRM system, project management system and so on.

### Solution

Set up an IPSec tunnel through the two routers (such as M30) to enable remote users to securely access the intranet through the internet.

Assume that router 1 is deployed at the headquarters, the basic information is shown as follows:

- The port on which the IPSec tunnel is established is WAN1.
- The WAN1 IP address is 202.105.11.22.
- The LAN network is 192.168.10.0/24.

Assume that router 2 is deployed in the subsidiary, the basic information is shown as follows:

- The port on which the IPSec tunnel is established is WAN1.
- The WAN1 IP address is 202.105.88.77.
- The LAN network is 192.168.1.0/24.

Assume that two routers make the IPSec connection, the pre-shared key used to verify the identity is UmXmL9UK.

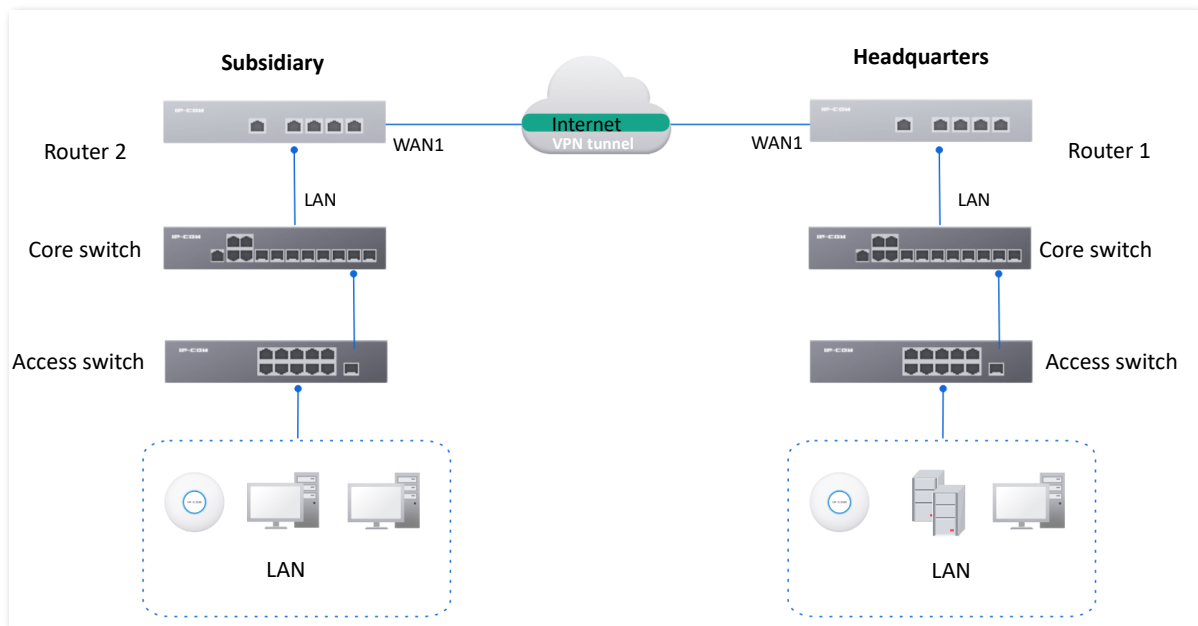

## Configuration procedure

Configure the router 1

Configure the router 2



Note

During the configuration process, if you need to set the advanced options of IPSec connection, keep the setting parameters of the two routers the same.

### I. Configure the router 1.

[Log in to the web UI of the router 1](#). Navigate to **More > VPN Service > IPSec**, and click **Add** to configure the following IPSec. The parameter settings are for reference only.

**Add IPSec**

IPSec  Enable  Disable

WAN Port: WAN1

Encapsulation Mode: Tunnel

Tunnel Name: IPSec\_1

Exchange Mode: Initiator Mode

Tunnel Protocol: ESP

Remote Gateway: 202.105.88.77

Local LAN/Mask: 192.168.10.0/24 ⓘ

Remote LAN/Mask: 192.168.1.0/24 ⓘ

Key Negotiation: Auto Negotiation

Authentication Type: Shared key

Pre-shared Key: UmXmL9UK

DPD Detection: Enable

DPD Detection Cycle: 10 s ⓘ

[Advanced >](#)

Cancel Save

The IPSec policy of router 1 is added successfully.

**IPSec** ⓘ

Add Delete

<input type="checkbox"/>	IPSec Status	WAN Port	Tunnel Name	Encapsulation Mode	Tunnel Protocol	Remote Gateway	Status	Operation
<input type="checkbox"/>	Disconnected	WAN1	IPSec_1	Tunnel	ESP	202.105.88.77	Enabled	<a href="#">Edit</a> <a href="#">Disable</a> <a href="#">Delete</a>

## II. Configure the router 2.

[Log in to the web UI of the router 2](#). Navigate to **More > VPN Service > IPSec**, and click **Add** to configure the following IPSec. The parameter settings are for reference only.

**Add IPSec**
✕

IPSec  Enable  Disable

WAN Port WAN1 ▼

Encapsulation Mode Tunnel ▼

Tunnel Name IPSec\_1

Exchange Mode Initiator Mode ▼

Tunnel Protocol ESP ▼

Remote Gateway 202.105.11.22

Local LAN/Mask 192.168.1.0/24 ⓘ

Remote LAN/Mask 192.168.10.0/24 ⓘ

Key Negotiation Auto Negotiation ▼

Authentication Type Shared key

Pre-shared Key UmXmL9UK

DPD Detection Enable ▼

DPD Detection Cycle 10 s ⓘ

[Advanced >](#)

Cancel
Save

The IPSec policy of router 2 is added successfully.

**IPSec**
?

Add
Delete

<input type="checkbox"/>	IPSec Status	WAN Port	Tunnel Name	Encapsulation Mode	Tunnel Protocol	Remote Gateway	Status	Operation
<input type="checkbox"/>	Disconnected	WAN1	IPSec_1	Tunnel	ESP	202.105.11.22	Enabled	<a href="#">Edit</a> <a href="#">Disable</a> <a href="#">Delete</a>

----End

## Verification

When the following IPSec policies are displayed in the IPSec list, the VPN tunnel is set up. The headquarters and subsidiary can securely access each other's LAN resources through the internet.

**IPSec List**
?

Name	SPI	Direction	Tunnel ID	Data Flow	Protocol	AH Authentication	ESP Authentication	ESP Encryption
IPSec_1	3473667327	out	202.105.11.22 --> 202.105.88.77	192.168.10.0/24-->192.168.1.0/24	AH	MD5	-	-
IPSec_1	3259173032	in	202.105.11.22 <-- 202.105.88.77	192.168.10.0/24<--192.168.1.0/24	AH	MD5	-	-

## 10.5 IPv6

### 10.5.1 Overview

IPv6, abbreviated for Internet Protocol Version, is the second-generation network layer protocol. IPv6 is an upgraded version of Internet Protocol version 4 (IPv4), which is the solution that addresses the relatively limited number of IP addresses possible under IPv4.

#### IPv6 address

An IPv6 address is 128 bits long and is arranged in eight groups, each of which is 16 bits. Each group is expressed as four hexadecimal digits and the groups are separated by colons. An IPv6 address is split into two parts:

- Network Prefix: n bits, equivalent to the network ID in the IPv4 address.
- Interface Identifier: 128-n bits, equivalent to the host ID in the IPv4 address.

#### Basic concept

##### ■ DHCPv6

Dynamic Host Configuration Protocol for IPv6 (DHCPv6) is a stateful protocol that assigns IPv6 addresses or prefixes and other configuration parameters to hosts.

##### ■ SLAAC

Stateless Address Autoconfiguration (SLAAC) is a stateless protocol. Hosts automatically generate IPv6 addresses or prefixes and other configuration parameters through Router Advertisement (RA).

### 10.5.2 Internet

[Log in to the web UI of the router](#), and navigate to **More > IPv6 > Internet** to enter the page. On this page, you can configure the IPv6 address of the corresponding WAN port.

There are two methods to obtain IPv6 addresses. Select the method based on the configuration of the upstream device.

Condition	Selection
The IP address assignment modes of the LAN port on the upstream device are DHCPv6, SLAAC or DHCPv6+SLAA.	<a href="#">Auto</a>
The upstream device is the ISP device, and the ISP provides a PPPoE user name and password that supports IPv6 service.	

Condition	Selection
The upstream device is the ISP device, and the ISP does not provide specific network parameters.	
The upstream device does not assign IP addresses.	
The upstream device is the ISP device, and the ISP provides a group of fixed IPv6 addresses for internet access, including the IP address, subnet mask, default gateway and DNS server information.	<a href="#">Manual</a>



If the WAN port is directly connected to the ISP network, ensure that you have enabled the IPv6 internet service. If you are not sure, contact your ISP for help.

## Auto

The WAN port automatically obtains IPv6 internet access information through DHCPv6 or SLAAC. After the IPv6 parameters of the WAN port are configured, you can view the IPv6 networking status in the **Connection Status** module on the right. The following figure is for reference only.

**Internet**
?

---

WAN1

Status  Enable  Disable

IPv6 Address Obtain Method Auto

DNS Obtain Method Auto

[Save](#)

**Connection Status**

Hardware Connection 1000 Mbps Full Duplex

Status Connected

Duration 0s

IPv6 Address fe80::da38:dff:fe3d:7de1

Subnet Prefix Length 64

Default Gateway -

Primary DNS 240c::6666

Secondary DNS -

### Parameter description

Parameter	Description
Mode	Status
	Used to enable or disable the IPv6 function of the corresponding WAN port.



Parameter	Description
IPv6 Address Obtain Method	Select <b>Auto</b> .
DNS Obtain Method	Specifies the method of the WAN port to obtain the DNS server address. <ul style="list-style-type: none"> <li>- <b>Auto</b>: The DNS server address is automatically obtained through DHCPv6 or SLAAC.</li> <li>- <b>Manual</b>: Enter the DNS server address manually.</li> </ul>
Primary DNS	Enter a correct IPv6 DNS server address.
Secondary DNS	 <b>Tip</b> If there is only one DNS address, <b>Secondary DNS</b> is not required.
Hardware Connection	Specifies the current rate and duplex mode of the WAN port.
Status	Specifies the connection status of the WAN port of the router. <ul style="list-style-type: none"> <li>- <b>Connected</b>: The WAN port of the router has been plugged into the Ethernet cable, and the IPv6 address information has been obtained.</li> <li>- <b>Connecting...</b>: The router is connecting to the upstream network device.</li> <li>- <b>Disconnected</b>: If it is not connected or fails to connect, check the Ethernet cable connection status and internet settings, or contact the corresponding ISP for help.</li> </ul>
Connection Status	
Duration	Specifies the duration of the WAN port access to the IPv6 network.
IPv6 Address	Specifies the IPv6 global unicast address of the WAN port.
Subnet Prefix Length	Specifies the network prefix number of the IPv6 address.
Default Gateway	Specifies the IPv6 default gateway of the WAN port.
Primary DNS	Specify the primary or secondary IPv6 DNS server address of the WAN port.
Secondary DNS	

## Manual

Access the internet using the fixed IPv6 address provided by ISP.

### Internet ?

WAN1

Status  Enable  Disable

IPv6 Address Obtain Method Manual ▼

IPv6 Address  / 64

IPv6 Default Gateway

DNS Obtain Method Manual ▼

Primary DNS

Secondary DNS  (Optional)

Save

#### Connection Status

Hardware Connection

Status

Duration -

IPv6 Address -

Subnet Prefix Length -

Default Gateway -

Primary DNS -

Secondary DNS -

## Parameter description

Parameter	Description
Status	Used to enable or disable the IPv6 function of the corresponding WAN port.
IPv6 Address Obtain Method	Select <b>Manual</b> .
IPv6 Address	Enter the IPv6 global unicast address provided by ISP.
IPv6 Default Gateway	Enter the IPv6 default gateway provided by ISP.
Mode	
DNS Obtain Method	Specifies the method of the WAN port to obtain the IPv6 DNS server address. Only <b>Manual</b> is allowed, which means entering the IPv6 DNS server address manually.
Primary DNS	Enter a correct IPv6 DNS server address.
Secondary DNS	<div style="display: flex; align-items: center; margin-bottom: 5px;">  Tip                 </div> If there is only one DNS address, <b>Secondary DNS</b> is not required.
Hardware Connection	Specifies the current rate and duplex mode of the WAN port.

Parameter	Description
	<p>Specifies the connection status of the WAN port of the router.</p> <ul style="list-style-type: none"> <li>- <b>Connected:</b> The WAN port of the router has been plugged into the Ethernet cable, and the IPv6 address information has been obtained.</li> <li>- <b>Connecting...:</b> The router is connecting to the upstream network device.</li> <li>- <b>Disconnected:</b> If it is not connected or fails to connect, check the Ethernet cable connection status and internet settings, or contact the corresponding ISP for help.</li> </ul>
Connection Status	Duration Specifies the duration of the WAN port access to the IPv6 network.
	IPv6 Address Specifies the IPv6 global unicast address of the WAN port.
	Subnet Prefix Length Specifies the network prefix number of the IPv6 address.
	Default Gateway Specifies the IPv6 default gateway of the WAN port.
	Primary DNS Specify the primary or secondary IPv6 DNS server address of the WAN port.
	Secondary DNS

### 10.5.3 LAN

[Log in to the web UI of the router](#), and navigate to **More > IPv6 > LAN** to enter the page.

On this page, you can configure the IPv6 address of the corresponding VLAN so that multiple devices in the LAN can share the broadband server.

The VLAN is disabled by default. The following displays the page when the function is enabled.

#### Parameter description

Parameter	Description
VLAN Interface	Specifies the VLAN interface for IPv6.
Status	Used to enable or disable the IPv6 function of the corresponding VLAN.
IPv6 Address Obtain Method	<p>Specifies the method to obtain IPv6 addresses.</p> <ul style="list-style-type: none"> <li>– <b>Auto:</b> The IPv6 address prefix of the VLAN is automatically obtained from upstream device by <b>Prefix Delegation Port</b>. The IPv6 address is automatically generated by the router according to the standard.</li> <li>– <b>Manual:</b> You need to manually set the IPv6 address prefix, complete IPv6 address and address assignment mode of the VLAN.</li> </ul>
Prefix Delegation Port	Specifies the WAN port which obtains the IPv6 address prefix of the VLAN from the upstream device. It needs to be selected when <b>IPv6 Address Obtain Method</b> is <b>Auto</b> .

Parameter	Description
IPv6 Address Prefix	Specifies the IPv6 address prefix of the VLAN.
IPv6 Address	Specifies the complete IPv6 address of the VLAN address.
Address Assignment Method	<p>Specifies the method that the router uses to assign IPv6 addresses to LAN clients.</p> <ul style="list-style-type: none"> <li>– <b>DHCPv6:</b> The client directly obtains all IPv6 address information from the DHCPv6 server, including the DNS server.</li> <li>– <b>SLAAC:</b> The client automatically generates IPv6 address information through RA, including the IPv6 address and DNS server.</li> <li>– <b>SLAAC+DHCPv6:</b> The client automatically generates the IPv6 address through RA and obtains other address information from the DHCPv6 server, such as the DNS server.</li> </ul>
Start Address	Specify the range of IPv6 addresses assigned by the DHCPv6 server.
End Address	When <b>Address Assignment Method</b> is <b>DHCPv6</b> , you need to configure parameters.
Primary Lifetime	Specifies the primary lifetime of the IPv6 address lease. If the client does not receive RA within the primary lifetime, it will deactivate the IPv6 address and no longer use the IPv6 address to create new connections, but can still receive messages with this IPv6 address as the destination address.
Valid Lifetime	Specifies the valid lifetime of the IPv6 address lease. After expiration, the IPv6 address will be deleted and invalid, and all sessions will be disconnected.
Primary DNS	Specify the IP address of the primary or secondary DNS server that is assigned to the client.
Secondary DNS	<p> <b>Note</b></p> <p>For the LAN devices to access the internet properly, ensure that the primary DNS you entered is the correct IP address of the DNS server or DNS proxy.</p>

# 11 System maintenance

## 11.1 System time

[Log in to the web UI of the router](#), and navigate to **Tool > System Time** to enter the page. On this page, you can configure the system time of the router.

To make the time-related functions effective, ensure that the system time of the router is set correctly. The router supports [Sync time with network time](#) and [Set system time manually](#). By default, **Sync Time with Network Time** is selected.

### 11.1.1 Sync time with network time

If you choose this method, the router automatically synchronizes its system time with the Network Time Server (NTS). As the router is connected to the internet, the system time is correct.

After the configuration is completed, you can refresh the page to check whether the system time of the router is correct.

**System Time**

Current Time 2024-01-11 17:37:40

Time Setup  Sync Time with Network Time  Set System Time Manually

Sync Period 1 hr

Time Zone (GMT+08:00) Beijing, Chongc

Save

#### Parameter description

Parameter	Description
Current Time	Specifies the current system time of the router.

Parameter	Description
Time Setup	Specifies the setting mode of the system time. Select <b>Sync Time with Network Time</b> .
Sync Period	Specifies the interval at which the router synchronizes the system time with a time server on the internet.
Time Zone	Specifies the standard time zone in which the router is currently located.

### 11.1.2 Set system time manually

If you choose this method, you can manually set a system time for the router. Every time the router reboots, you need to reconfigure the system time.

After the configuration is completed, you can refresh the page to check whether the system time of the router is correct.

**System Time**

Current Time 2024-01-11 17:38:34

Time Setup  Sync Time with Network Time  Set System Time Manually

Date/Time 2024-01-11 17:37:24 Sync with Local PC Time

Save

#### Parameter description

Parameter	Description
Current Time	Specifies the current system time of the router.
Time Setup	Specifies the setting mode of the system time. Select <b>Set System Time Manually</b> .
Date/Time	Click  to select the correct time, or click <b>Sync with Local PC Time</b> to synchronize the time of the router with the computer which is managing the router.

## 11.2 Diagnostic tool

### 11.2.1 Ping

Ping is used to check whether the connection is correct and the connection quality.

[Log in to the web UI of the router](#), and navigate to **Tool > Diagnosis** to enter the page. On this page, you can check whether the connection is correct and the connection quality with **Ping**.

Assume that you need to detect whether the link between the router and the Google management network (www.google.com) is unblocked.

**To perform Ping test:**

1. [Log in to the web UI of the router](#), and navigate to **Tool > Diagnosis**.
2. Select **Ping** from the **Tool** drop-down list box.
3. Set **Egress Option** to the interface for the test, which is **WAN1** in this example.
4. Enter the IP address or domain name of the ping target, which is **www.google.com** in this example.
5. Set **Tx Packets** to the number of packets sent in the Ping test, which is **10** in this example.
6. Set **Tx Packet Size** to the size of packets sent in the Ping test, which is **10** in this example.
7. Click **Start**.

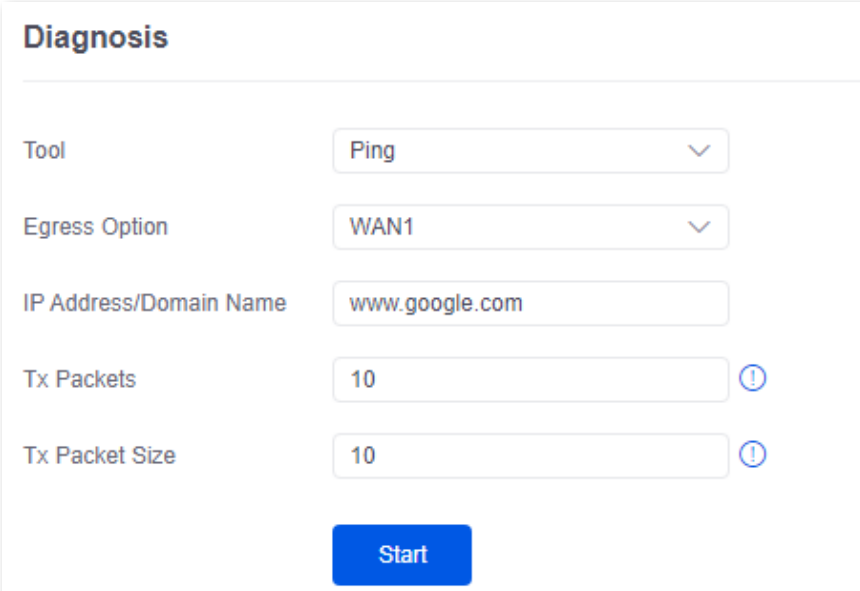

The screenshot shows a web interface titled "Diagnosis". It contains five configuration fields and a "Start" button. The fields are: "Tool" (dropdown menu set to "Ping"), "Egress Option" (dropdown menu set to "WAN1"), "IP Address/Domain Name" (text input field containing "www.google.com"), "Tx Packets" (text input field containing "10" with a warning icon to its right), and "Tx Packet Size" (text input field containing "10" with a warning icon to its right). A blue "Start" button is located at the bottom center of the form.

----End



## Parameter description

Parameter	Description
Egress Option	Specifies the interface from which the data goes out.
IP Address/Domain Name	Specifies the IP address or domain name of the target host.
Tx Packets	Specifies the number of data packets sent in the Ping test.
Tx Packet Size	Specifies the size of data packets sent in the Ping test.

The diagnosis result is shown in the lower part of the page. See the following figure.

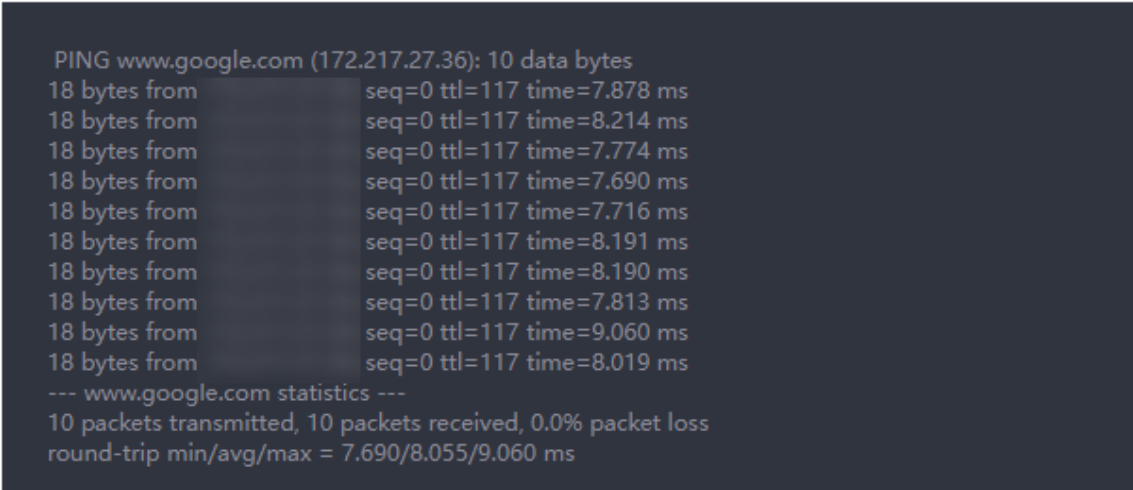

```
Diagnosis Result
PING www.google.com (172.217.27.36): 10 data bytes
18 bytes from seq=0 ttl=117 time=7.878 ms
18 bytes from seq=0 ttl=117 time=8.214 ms
18 bytes from seq=0 ttl=117 time=7.774 ms
18 bytes from seq=0 ttl=117 time=7.690 ms
18 bytes from seq=0 ttl=117 time=7.716 ms
18 bytes from seq=0 ttl=117 time=8.191 ms
18 bytes from seq=0 ttl=117 time=8.190 ms
18 bytes from seq=0 ttl=117 time=7.813 ms
18 bytes from seq=0 ttl=117 time=9.060 ms
18 bytes from seq=0 ttl=117 time=8.019 ms
--- www.google.com statistics ---
10 packets transmitted, 10 packets received, 0.0% packet loss
round-trip min/avg/max = 7.690/8.055/9.060 ms
```

## 11.2.2 Tracert

Tracert is used to detect the routes that a packet takes from a router to a destination host.

[Log in to the web UI of the router](#), and navigate to **Tool > Diagnosis** to enter the page. On this page, you can detect the routes that a packet takes from a router to a destination host with **Tracert**.

Assume that you need to detect the routes from the router to the Google management network (www.google.com).

### To perform Tracert test:

1. [Log in to the web UI of the router](#), and navigate to **Tool > Diagnosis**.
2. Select **Tracert** from the **Tool** drop-down list box.
3. Set **Egress Option** to the interface for the test, which is **WAN1** in this example.
4. Enter the IP address or domain name of the tracert target, which is **www.google.com** in this example.

5. Click **Start**.

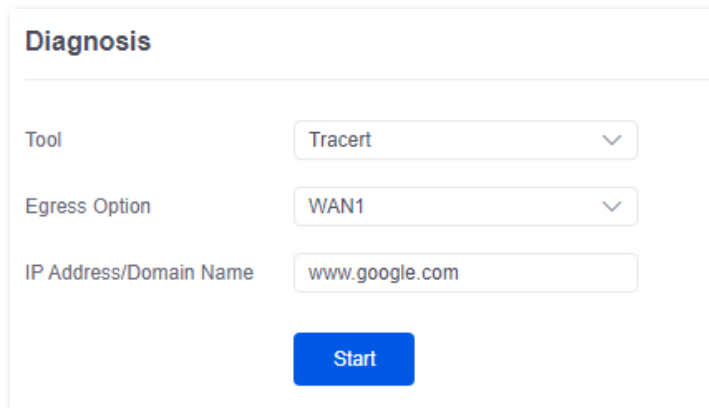

**Diagnosis**

Tool: Tracert

Egress Option: WAN1

IP Address/Domain Name: www.google.com

Start

----End

The diagnosis result is shown in the lower part of the page. See the following figure.

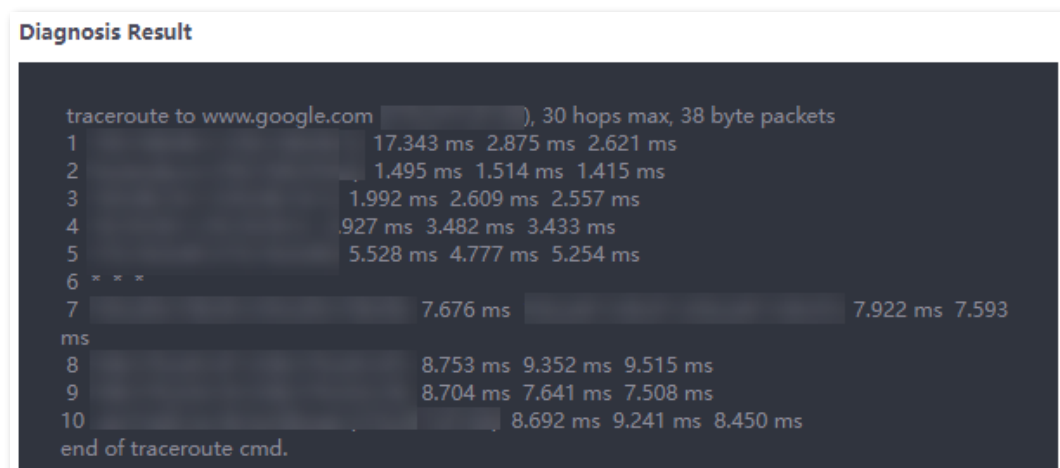

```
Diagnosis Result
tracert to www.google.com ( ), 30 hops max, 38 byte packets
 1 17.343 ms 2.875 ms 2.621 ms
 2 1.495 ms 1.514 ms 1.415 ms
 3 1.992 ms 2.609 ms 2.557 ms
 4 927 ms 3.482 ms 3.433 ms
 5 5.528 ms 4.777 ms 5.254 ms
 6 * * *
 7 7.676 ms 7.922 ms 7.593
ms
 8 8.753 ms 9.352 ms 9.515 ms
 9 8.704 ms 7.641 ms 7.508 ms
10 8.692 ms 9.241 ms 8.450 ms
end of traceroute cmd.
```

### Parameter description

Parameter	Description
Egress Option	Specifies the interface from which the data goes out.
IP Address/Domain Name	Specifies the IP address or domain name of the target host.

## 11.2.3 Packet capture tool

**Packet Capture Tool** is a network data collection and analysis tool, which can completely intercept the specified data packets in the network to provide analysis.

[Log in to the web UI of the router](#), and navigate to **Tool > Diagnosis** to enter the page. On this page, you can intercept the specified data packets of an interface with **Packet Capture Tool**.

Assume that you want to intercept all types of data packets from the router's LAN4 port. The IP address of the LAN4 port is 192.168.10.250, which belongs to **VLAN\_Default**.

### Configuration procedure:

1. [Log in to the web UI of the router](#), and navigate to **Tool > Diagnosis**.
2. Select **Packet Capture Tool** from the **Tool** drop-down list box.
3. Set **Interface** to the VLAN interface to intercept data, which is **VLAN\_Default** in this example.
4. Set **IP/MAC Address** of the LAN4 port, which is **192.168.10.250** in this example.
5. Set **Protocol**, which is **ALL** in this example.
6. Click **Start**.

The screenshot shows the 'Diagnosis' configuration page. It features four input fields: 'Tool' (set to 'Packet Capture Tool'), 'Interface' (set to 'VLAN\_Default'), 'IP/MAC Address' (set to '192.168.10.250'), and 'Protocol' (set to 'ALL'). A blue 'Start' button is located at the bottom of the form. A note next to the IP/MAC Address field states: 'If it is left blank, all addresses are captured.'

7. (Optional) During packet capture, click **End** as required.
8. Click **Download**.

The pcap file will be downloaded to the local computer, which can be opened and viewed with the packet capture firmware (such as **Wireshark**).

This screenshot shows the 'Diagnosis' configuration page after the 'Start' button has been clicked. The configuration fields remain the same. Below the fields, there are two blue buttons: 'Start' and 'Download'. At the bottom, there is a 'Diagnosis Result' section with a dark grey background and the text: 'Click Download to download the diagnosis content.'

----End

## Parameter description

Parameter	Description
Interface	Specifies the VLAN interface whose data will be intercepted.
IP/MAC Address	<p>Specifies the IP address or MAC address whose data will be intercepted.</p> <p> Tip</p> <p>If the IP address or MAC address does not exist in the network or is not under the VLAN, no packets will be intercepted.</p>
Protocol	<p>Specifies the protocol type of data to be intercepted. <b>ALL</b> indicates that <b>ICMP</b>, <b>TCP</b>, <b>UDP</b> and <b>ARP</b> are all included.</p> <ul style="list-style-type: none"><li>- <b>ICMP</b>: Abbreviated for Internet Control Message Protocol. It is used to transmit control messages between IP hosts and routers, including whether the network or the host is reachable, and whether the route is available.</li><li>- <b>TCP</b>: Abbreviated for Transmission Control Protocol. The connection is established through the three-way handshaking. When the communication is completed, the connection should be removed. It can only be used for end-to-end communication, such as Telnet and FTP.</li><li>- <b>UDP</b>: Abbreviated for User Datagram Protocol. UDP data includes destination port and source port information. The communication does not require connection, and the broadcast transmission can be realized. Services using <b>UDP</b> include DNS and SNMP.</li><li>- <b>ARP</b>: Abbreviated for Address Resolution Protocol. It is a TCP/IP protocol that obtains physical addresses based on IP addresses.</li></ul>

## 11.2.4 AP diagnosis

[Log in to the web UI of the router](#), and navigate to **Tool > Diagnosis** to enter the page. On this page, you can view the AP status based on the MAC address, including online status, IP address, and AP group to which it belongs.

Assume that you want to perform diagnosis on an AP (MAC address: D8:38:0D:C2:10:40) in the network, follow the steps below:

1. [Log in to the web UI of the router](#), and navigate to **Tool > Diagnosis**.
2. Select **AP Diagnosis** for **Tool**.
3. Set **AP MAC Address** to the MAC address of the AP, which is **D8:38:0D:C2:10:40** in this example.
4. Click **Start**.

The diagnosis result is shown in the lower part of the page. See the following figure.

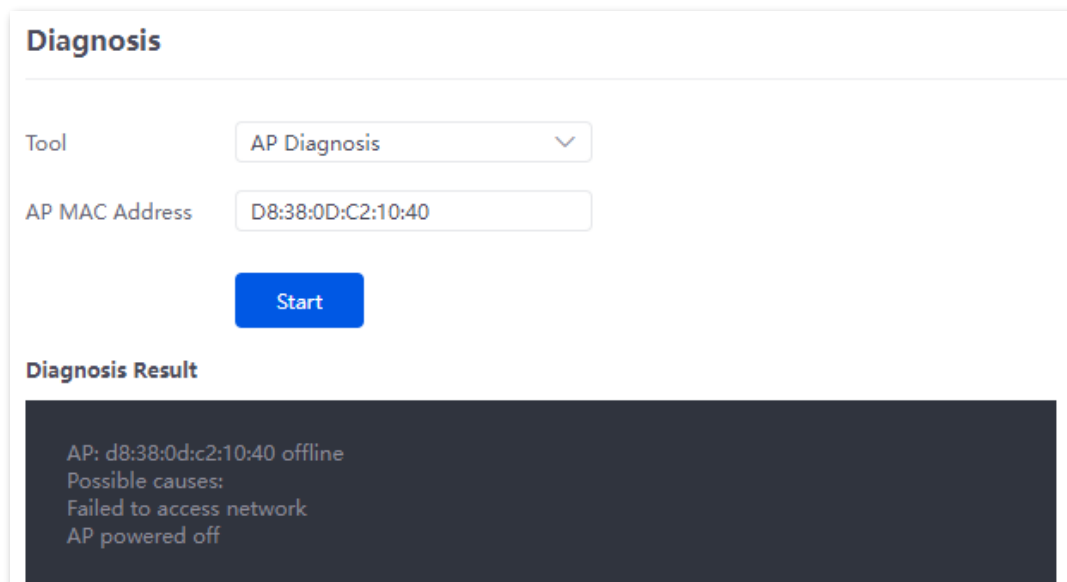

The screenshot displays the 'Diagnosis' web interface. At the top, the title 'Diagnosis' is shown. Below it, there are two input fields: 'Tool' with a dropdown menu set to 'AP Diagnosis', and 'AP MAC Address' with the value 'D8:38:0D:C2:10:40'. A blue 'Start' button is positioned below these fields. Underneath the button, the 'Diagnosis Result' section is visible, containing the following text: 'AP: d8:38:0d:c2:10:40 offline', 'Possible causes:', 'Failed to access network', and 'AP powered off'.

---End

## 11.2.5 System diagnosis

[Log in to the web UI of the router](#), and navigate to **Tool > Diagnosis** to enter the page. On this page, you can view the status information of all processes in the system.

**To perform system diagnosis:**

1. [Log in to the web UI of the router](#), and navigate to **Tool > Diagnosis**.
2. Select **System Diagnosis** for **Tool**.
3. Click **Start**.

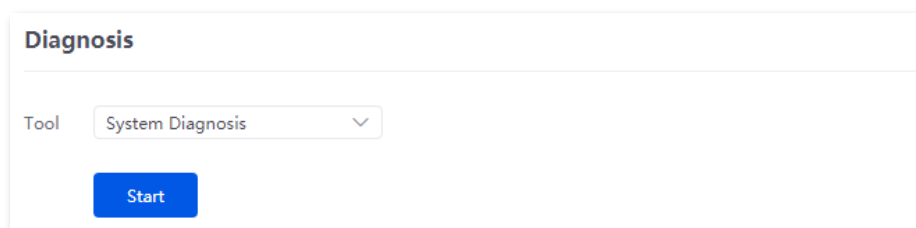

---End

The diagnosis result is shown in the lower part of the page, and you can pull the scroll bar to see more information. See the following figure.

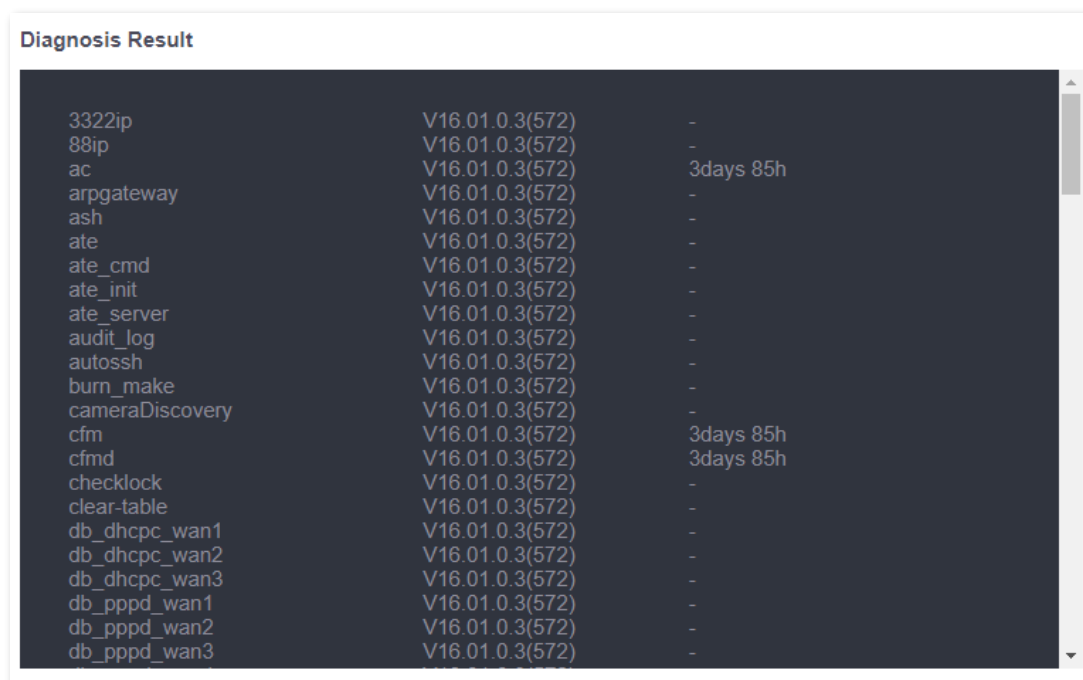

## 11.2.6 Interface info

[Log in to the web UI of the router](#), and navigate to **Tool > Diagnosis** to enter the page. On this page, you can view the interface information of the router, including the physical interface, bridging interface, tunnel interface and VLAN virtual interface. The bridging interface and the VLAN virtual interface are generated when the VLAN is created, but no VLAN virtual interface is generated when the VLAN is 0. The tunnel interface is generated when the SSID policy is created.

**To check the interface information:**

1. [Log in to the web UI of the router](#), and navigate to **Tool > Diagnosis**.
2. Select **Interface Info** for **Tool**.
3. Click **Start**.

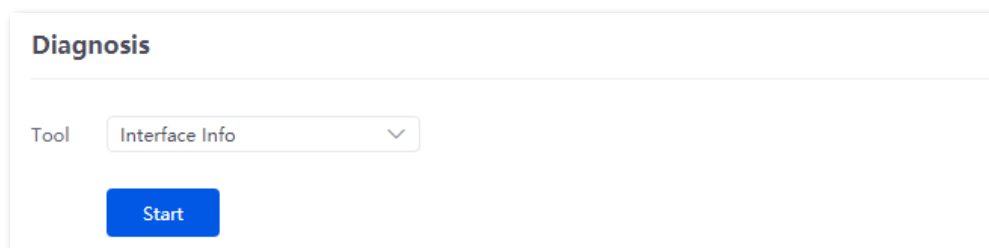

---End

The diagnosis result is shown in the lower part of the page, and you can pull the scroll bar to see more information. See the following figure.

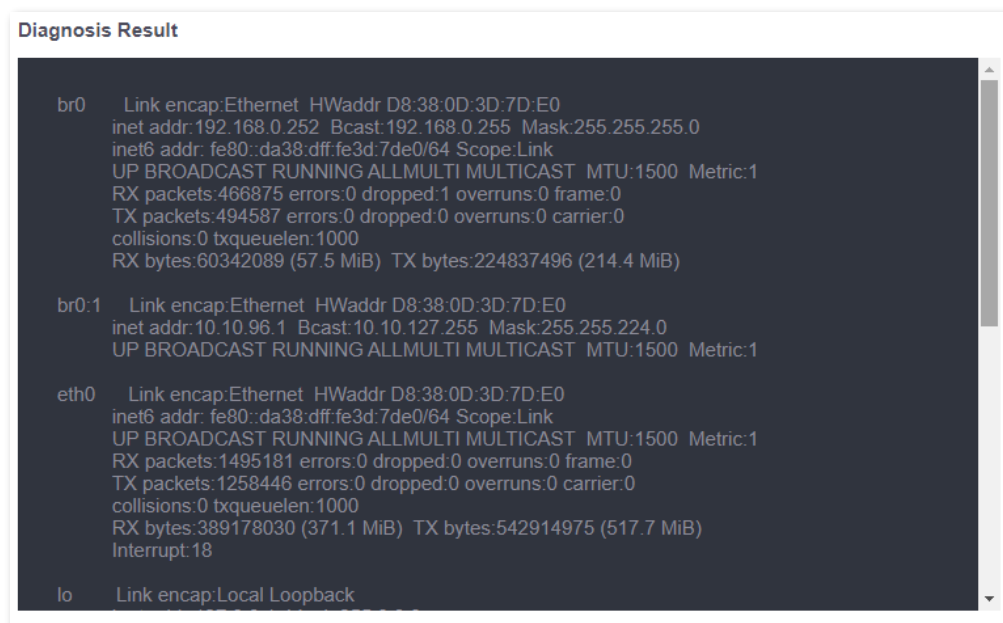

## 11.3 Log center

[Log in to the web UI of the router](#), and navigate to **Tool > Log Center** to enter the page. On this page, you can view the log information recorded by the router.

The log center records the **System Log**, **Operating Log** and **Running Log** of the router. In case of network failure, you can use the router's log center to troubleshoot the problem.

The time of the logs depends on the system time of the router. To ensure the time of the logs is correct, set correctly [System time](#) of the router first.

### 11.3.1 System log

The **System Log** records events of the system, such as DHCP log, dial-up log.

[Log in to the web UI of the router](#), and navigate to **Tool > Log Center > System Log** to enter the page. Click the drop-down list box on this page. You can view certain log information of the router.

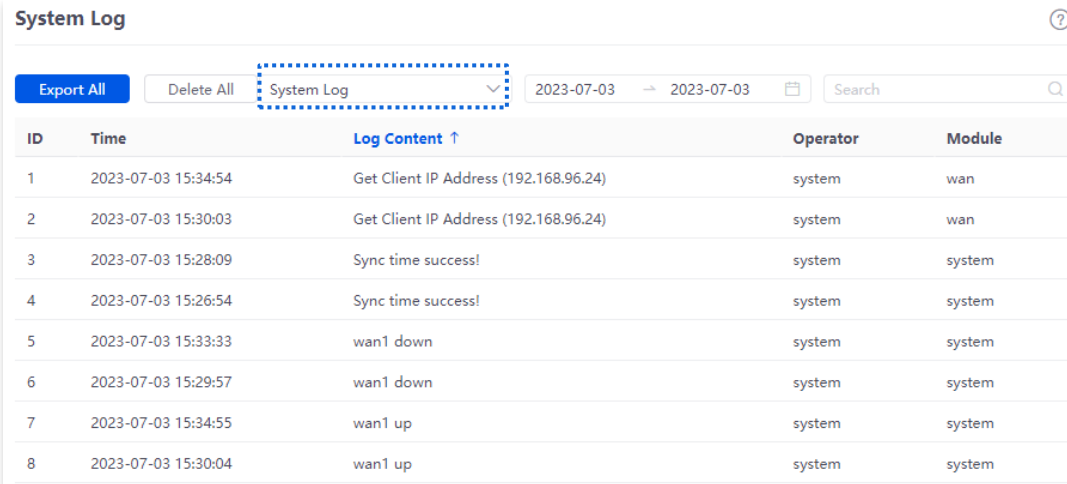

The screenshot shows the 'System Log' interface. At the top, there are buttons for 'Export All' and 'Delete All', a dropdown menu currently set to 'System Log', and date filters for '2023-07-03'. Below this is a table with columns: ID, Time, Log Content, Operator, and Module. The table contains 8 rows of log entries.

ID	Time	Log Content ↑	Operator	Module
1	2023-07-03 15:34:54	Get Client IP Address (192.168.96.24)	system	wan
2	2023-07-03 15:30:03	Get Client IP Address (192.168.96.24)	system	wan
3	2023-07-03 15:28:09	Sync time success!	system	system
4	2023-07-03 15:26:54	Sync time success!	system	system
5	2023-07-03 15:33:33	wan1 down	system	system
6	2023-07-03 15:29:57	wan1 down	system	system
7	2023-07-03 15:34:55	wan1 up	system	system
8	2023-07-03 15:30:04	wan1 up	system	system

### 11.3.2 Operating log

The **Operating Log** records the operation information that the user performed in the system, such as login log, and configuration modification.

[Log in to the web UI of the router](#), and navigate to **Tool > Log Center > Operating Log** to enter the page. You can view certain operation information of the router by selecting log types from the drop-down list box highlighted on the following figure.

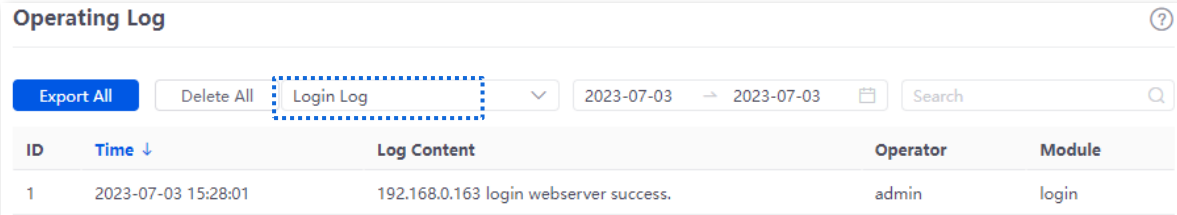

The screenshot shows the 'Operating Log' interface. At the top, there are buttons for 'Export All' and 'Delete All', a dropdown menu currently set to 'Login Log', and date filters for '2023-07-03'. Below this is a table with columns: ID, Time, Log Content, Operator, and Module. The table contains 1 row of log entries.

ID	Time ↓	Log Content	Operator	Module
1	2023-07-03 15:28:01	192.168.0.163 login webservice success.	admin	login



### 11.3.3 Running log

The **Running Log** records the information of the system process running and the AP report.

[Log in to the web UI of the router](#), and navigate to **Tool > Log Center > Running Log** to enter the page. You can view certain information of the system process running and the AP report of the router by selecting log types from the drop-down list box highlighted on the following figure.

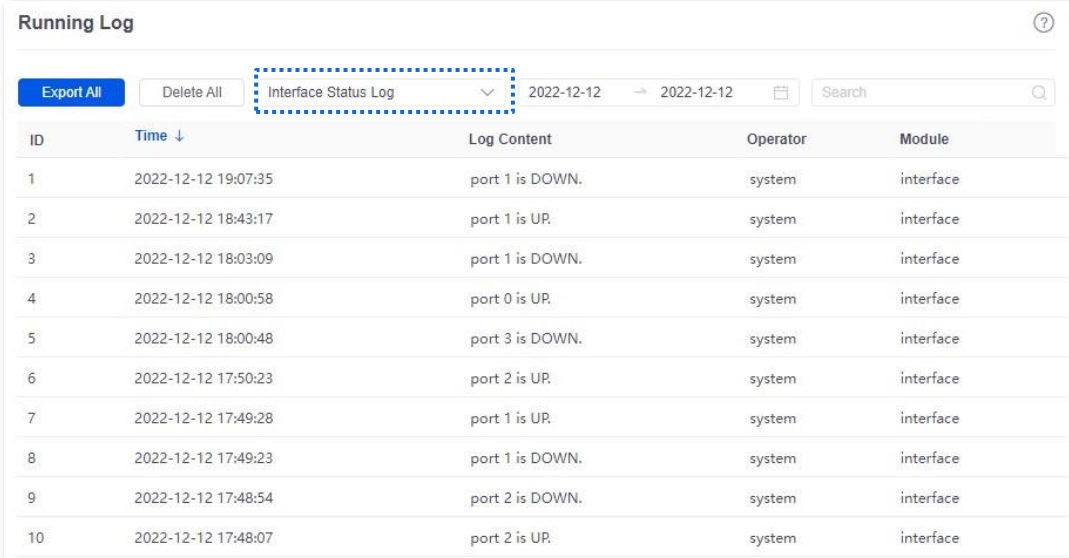

ID	Time ↓	Log Content	Operator	Module
1	2022-12-12 19:07:35	port 1 is DOWN.	system	interface
2	2022-12-12 18:43:17	port 1 is UP.	system	interface
3	2022-12-12 18:03:09	port 1 is DOWN.	system	interface
4	2022-12-12 18:00:58	port 0 is UP.	system	interface
5	2022-12-12 18:00:48	port 3 is DOWN.	system	interface
6	2022-12-12 17:50:23	port 2 is UP.	system	interface
7	2022-12-12 17:49:28	port 1 is UP.	system	interface
8	2022-12-12 17:49:23	port 1 is DOWN.	system	interface
9	2022-12-12 17:48:54	port 2 is DOWN.	system	interface
10	2022-12-12 17:48:07	port 2 is UP.	system	interface

## 11.4 Maintenance

### 11.4.1 Device information

[Log in to the web UI of the router](#), and navigate to **Tool > Maintenance > Device Info**. On this page, you can view the basic composition and usage of current system hardware, as well as system time and running time.

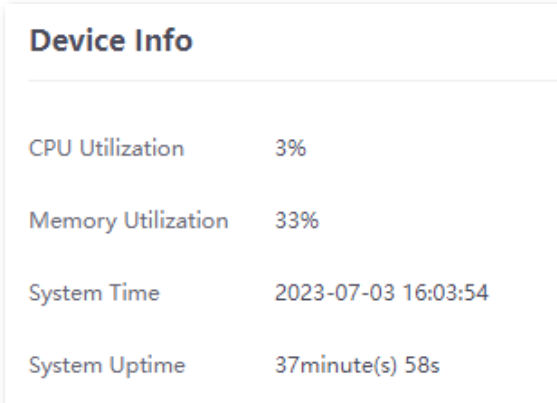

Device Info	
CPU Utilization	3%
Memory Utilization	33%
System Time	2023-07-03 16:03:54
System Uptime	37minute(s) 58s

### 11.4.2 Restore & Backup

#### Overview

You can use the Backup function to copy the current configurations of the router to the local computer and use the Configuration Restoration function to restore the configurations of the router to the backed-up configurations.

You are recommended to back up the configuration after it is significantly changed. When the performance of your router decreases because of an improper configuration, or after you restore the router to factory settings, you can use this function to restore the configuration that has been backed up.

[Log in to the web UI of the router](#), and navigate to **Tool > Maintenance > Restore & Backup**. On this page, you can use the Backup and Restore function.

#### Backup

1. [Log in to the web UI of the router](#).
2. Navigate to **Tool > Maintenance > Restore & Backup**.
3. Click **Export**.

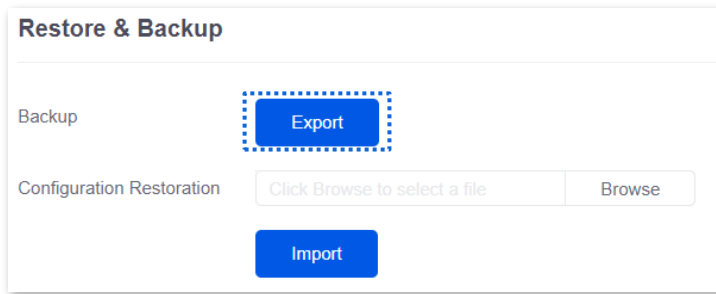

----End

The browser will download a configuration file named **RouterCfm.cfg**.



If the message “This type of file can harm your computer. Do you want to keep RouterCfm.cfg anyway?” appears on the page, click “Keep”.

## Restore

1. [Log in to the web UI of the router.](#)
2. Navigate to **Tool > Maintenance > Restore & Backup**.
3. Click **Browse**, and select the configuration file you have backed up.

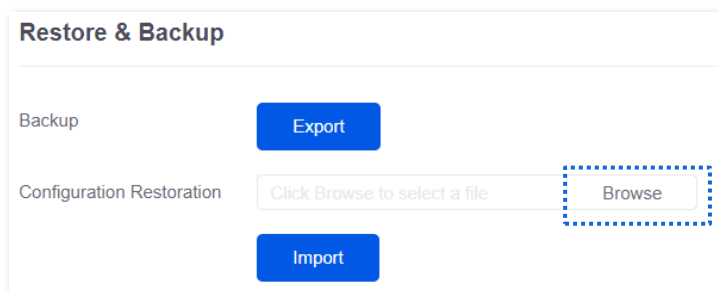

4. Click **Import**.

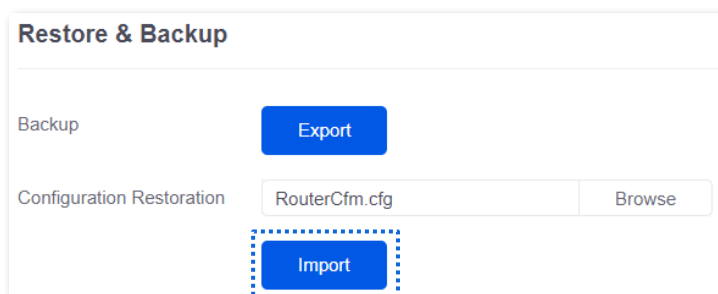

5. Confirm the prompt information, and click **OK**.

----End

A reboot progress bar appears. When the progress bar reaches 100%, the router is restored successfully.

### 11.4.3 Factory settings restore

#### Overview

If the internet is inaccessible for unknown reasons, or you forget the login password, you can reset the router to resolve the problems.

The router supports two resetting methods:

- [Reset the device using web UI](#)
- [Reset the device using the RESET button](#)

After the reset, the default LAN IP address of the router is 192.168.0.252.



Note

- Resetting the router clears all current configurations. It is recommended to [back up](#) the current configurations before the reset.
- After the reset, the router will be restored to factory settings and you can access the internet only after you reconfigure it. Reset the router with caution.
- To avoid damaging the router, ensure that the router is properly powered on throughout the reset.

#### Reset the device using web UI

1. [Log in to the web UI of the router.](#)
2. Navigate to **Tool > Maintenance > Factory Settings Restore.**
3. click **Reset.**

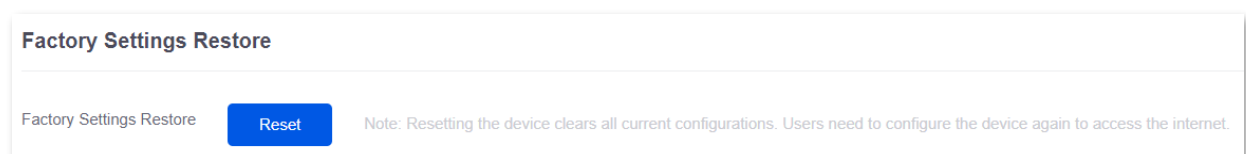

4. Confirm the prompt information, and click **OK.**

----End

A reset progress bar appears. When the progress bar reaches 100%, the router is restored to factory settings successfully. Please configure the router again.

## Reset the device using the reset button

When using this method, you can restore the router to factory settings without logging in to the web UI of the router. The operation method is as follows:

When the **SYS** LED indicator blinks, hold down the reset button (**RESET** or **Reset**) with a needle-like object for about 8 seconds and release it when the **SYS** LED indicator lights solid green.

When the **SYS** LED indicator blinks again, the router is reset successfully.

## 11.5 Upgrade service

### 11.5.1 Overview

[Log in to the web UI of the router](#), and navigate to **Tool > Upgrade Service**. On this page, you can upgrade the router's firmware and feature-library.

- [System firmware upgrade](#): You can upgrade the firmware of the router to experience more functions and get a better user experience. The router supports **Local Upgrade** and **Online Upgrade**. The default upgrade mode is **Local Upgrade**.
- [Feature-Library upgrade](#): You can update the router's feature-library. The upgrading of feature-library does not incur the upgrading of the system. The router supports **Local Upgrade** and **Online Upgrade**. The default upgrade mode is **Local Upgrade**.

#### Parameter description

Parameter	Description
Local Upgrade	Download the upgrading file from the official website ( <a href="http://www.ip-com.com.cn">www.ip-com.com.cn</a> ) to the local computer, decompress it and upgrade the system using the decompressed file. The format of the decompressed file is suffixed with <b>.bin</b> .
Online Upgrade	When the router is connected to the internet, it will automatically detect whether there is a new program for upgrading and show the relevant information about the upgrading firmware detected. After you click <b>Upgrade</b> , the router will automatically download the upgrading file and perform upgrading. Do not power off the device during the process.

## 11.5.2 System firmware upgrade



Note

- To avoid damage to the router, ensure that the correct upgrade file is used. Generally, a firmware upgrade file is suffixed with **.bin**.
- During the upgrade, do not power off the router.

[Log in to the web UI of the router](#), and navigate to **Tool > Upgrade Service > System Firmware Upgrade**. On this page, you can upgrade the firmware of the router.

1. Visit [www.ip-com.com.cn](http://www.ip-com.com.cn), download the upgrade firmware of the corresponding model to your computer and unzip it.
2. [Log in to the web UI of your router](#), and navigate to **Tool > Upgrade Service > System Firmware Upgrade**.
3. Select **Local Upgrade** for **Upgrade Mode**.
4. Click **Browse**. Select and upload the firmware that has been downloaded to your computer in step 1, and click **Upgrade**.

The screenshot shows the 'System Firmware Upgrade' web interface. It features a title bar at the top. Below the title, there are three main sections: 'Current Software Version' showing 'V16.01.0.5(1124)', 'Upgrade Mode' with radio buttons for 'Local Upgrade' (selected) and 'Online Upgrade', and 'Upgrade File Path' with a text input field containing 'US\_M30V3.0' and a 'Browse' button. At the bottom of the form is a large blue 'Upgrade' button, which is highlighted with a dashed blue border.

5. Confirm the prompt information, and click **OK**.

----End

After the progress bar completes, you can log in to the router again and check whether **Current Software Version** in **Tool > Upgrade Service > System Firmware Upgrade** is the one that you upgraded. If yes, the upgrade is successful.



To better experience the stability and new functions of the firmware, after the upgrade, you are recommended to [restore the router to factory settings](#) and configure it again.

### 11.5.3 Feature-Library upgrade



Note

- To avoid damage to the router, ensure that the correct upgrade file is used. Generally, a firmware upgrade file is suffixed with **.bin**.
- During the upgrade, do not power off the router.

[Log in to the web UI of the router](#), and navigate to **Tool > Upgrade Service > Feature-Library Upgrade**. On this page, you can upgrade the router's feature-library.

1. Visit [www.ip-com.com.cn](http://www.ip-com.com.cn), download the latest feature-library file of the corresponding model and save it to your computer.
2. [Log in to the web UI of your router](#), and navigate to **Tool > Upgrade Service > Feature-Library Upgrade**.
3. Select **Local Upgrade** for **Upgrade Mode**.
4. Click **Browse**. Select and upload the feature-library file that has been downloaded to your computer in step **1**, and click **Upgrade**.

The screenshot shows the 'Feature-Library Upgrade' web interface. At the top, it displays 'Current Software Version v1.0'. Below this, there are two radio buttons for 'Upgrade Mode': 'Local Upgrade' (which is selected) and 'Online Upgrade'. Underneath, there is a text input field for 'Upgrade File Path' and a 'Browse' button. At the bottom of the form, a blue 'Upgrade' button is highlighted with a dashed blue border.

----End

After the progress bar completes, you can log in to the router again and check whether **Current Software Version** in **Tool > Upgrade Service > Feature-Library Upgrade** is the one that you upgraded. If yes, the upgrade is successful.



## 11.6 Reboot services

### 11.6.1 Reboot

[Log in to the web UI of the router](#), and navigate to **Tool > Reboot Services > Reboot**. On this page, you can reboot the router to make certain settings take effect and improve the performance of the router. Rebooting the device disconnects from the current network. The process lasts about 1 minute. It is recommended to reboot the device when the network is relatively idle.

#### Reboot steps:

[Log in to the web UI of the router](#), and navigate to **Tool > Reboot Services > Reboot**, and click **Reboot**.

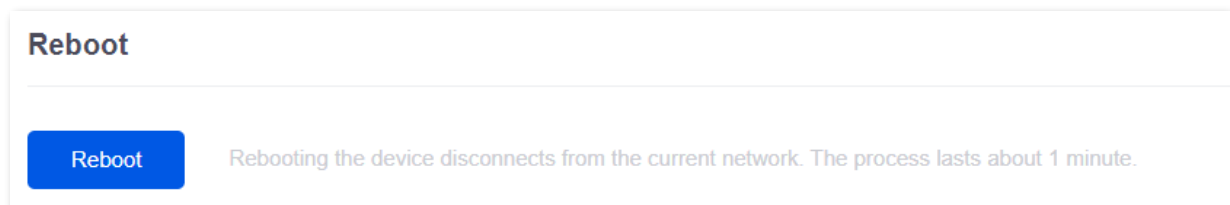

### 11.6.2 Scheduled reboot

[Log in to the web UI of the router](#), and navigate to **Tool > Reboot Services > Scheduled Reboot**. On this page, by setting the router to reboot periodically during leisure time, you can prevent the decreasing of performance and instability of the router after running for a long period.



The time of reboot depends on the system time of the router. To ensure the time of the reboot is correct, set correctly [System time](#) of the router first.

#### Scheduled reboot steps:

1. [Log in to the web UI of the router](#).
2. Navigate to **Tool > Reboot Services > Scheduled Reboot**.
3. Enable the **Scheduled Reboot** function.
4. Select the time when the router will automatically reboot, which is **03:00** in this example.
5. Select the reboot date, which is **Thur.** in this example.

6. Click **Save**.

### Scheduled Reboot

Scheduled Reboot  Enable  Disable

Reboot Time  

Cycle  Every Day

Mon.  Tues.  Wed.  Thur.  Fri.  Sat.  Sun.

----End

After the above settings are completed, the router will automatically reboot at 3:00 am every Thursday.

## 11.7 Network diagnosis

### 11.7.1 Configure network diagnosis

[Log in to the web UI of the router](#), and navigate to **Tool > Network Diagnosis > Network Diagnosis** to enter the page.

On this page, you can detect the network status of the router. If a network abnormality is detected, it will be reported to the [network monitoring logs](#).



After **Start** is clicked, the process may last for a period of time and cannot be paused or ended manually. Operate during idle periods.

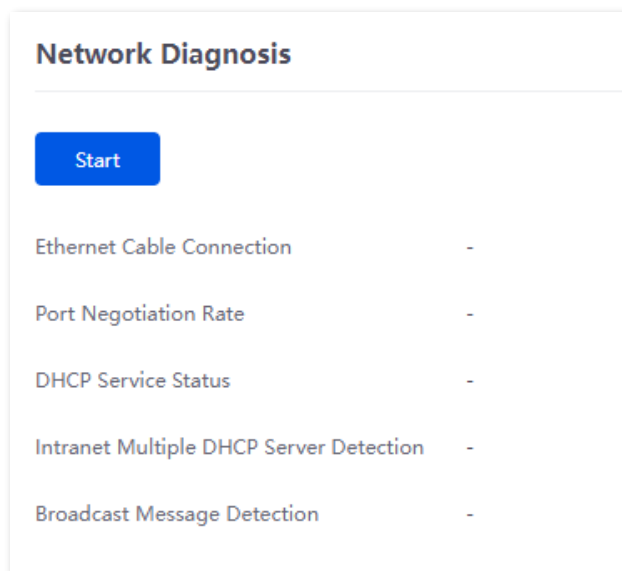

### 11.7.2 Client detection

[Log in to the web UI of the router](#), and navigate to **Tool > Network Diagnosis > Client Detection** to enter the page.

On this page, you can check the IP address of a client through its MAC address. The following figure is for reference only.

**Client Detection**

Detection Item: Check IP Address with MAC A

Query Content: Enter a MAC address

Start

Diagnosis Result

### Parameter description

Parameter	Description
Detection Item	Used to check the IP address of a client through its MAC address.
Query Content	Specifies the MAC address of the client whose IP address is to be queried.

## 11.7.3 WAN port diagnosis

[Log in to the web UI of the router](#), and navigate to **Tool > Network Diagnosis > WAN Port Diagnosis**.

On this page, you can perform a network test on the WAN port of the router.

**Test**

Ethernet Port Selection: WAN1

WAN Port Diagnosis: Dynamic IP Address, Ethernet connected, Connected

DNS Diagnosis: Normal

Delay Diagnosis: 11ms

HTTP Access Diagnosis: Normal

Test

### Parameter description

Parameter	Description
Ethernet Port Selection	Specifies the WAN port to be tested.
WAN Port Diagnosis	Used to test the WAN port's connection type, Ethernet cable connection status and internet connection status.
DNS Diagnosis	Used to test whether the WAN port can resolve the domain name properly.
Delay Diagnosis	Used to test the network delay of the WAN port.
HTTP Access Diagnosis	Used to test whether the WAN port can receive HTTP response normally.

## 11.7.4 Network monitoring logs

[Log in to the web UI of the router](#), and navigate to **Tool > Network Diagnosis > Network Monitoring Logs**.

On this page, you can check the network monitoring logs recorded by the router on this page. If the network is faulty, you can perform troubleshooting using these logs.



### Parameter description

Parameter	Description
Time	Specifies the time when the log is generated.
Log Content	Specifies the content of the abnormal log.
Manufacturer	Specifies the manufacturer of the DHCP server detected in the LAN.
MAC Address	Specifies the MAC address of the DHCP server detected in the LAN.
IP Address	Specifies the IP address of the DHCP server detected in the LAN.

## 11.8 System account

[Log in to the web UI of the router](#), and navigate to **Tool > System Account** to enter the page.

On this page, you can add, modify or delete the administrator and visitor accounts.

System Account <span style="float: right;">?</span>			
<a href="#">Add</a>			
Role	Remark	Login IP Address Limit	Operation
Administrator	-	-	<a href="#">Edit</a> <a href="#">Delete</a>

### Parameter description

Parameter	Description
<a href="#">Add</a>	Used to add a new system account.
Role	<p>Specifies the user role in managing the web UI. There is an administrator account by default. The operation authority of corresponding user roles is described as follows:</p> <ul style="list-style-type: none"> <li>- <b>Administrator:</b> Able to view and configure all functions of the router.</li> <li>- <b>Visitor:</b> Only able to view configurations of the router except system account information.</li> </ul>
Password	Used to set the login password of the account.
Confirm Password	
Remark	Specifies the remark for the account. You can enter the description for the operation permission of the account.
Login IP Address Limit	Specifies the IP addresses of the users of the account. After the configuration is completed, only users with the IP address or within the IP address range can use the account to access the web UI.
Operation	<p>Used to edit or delete account information. The super-administrator account cannot be added or deleted.</p> <p><a href="#">Edit</a>: Used to modify the account information.</p> <p><a href="#">Delete</a>: Used to delete the account information.</p>

# Appendix

## Connect the router to the internet in pure AC mode

1. [Log in to the web UI in pure AC mode.](#)
2. Navigate to **Network > LAN Settings**, on the **Configure IP Address** module, configure the LAN port information of the router and click **Save**. The following figure is for reference only.
  - Set **IP Address** of the router to one on the same network segment as the LAN IP address of the gateway, and is not occupied by other devices.
  - Retain **Subnet Mask** to default settings, which is **255.255.255.0**.
  - Set **Default Gateway** to the LAN IP address of the gateway.
  - Set **Primary DNS** to the correct IP address of DNS server or DNS proxy.

**Configure IP Address**

IP Address: 192 . 168 . 1 . 10

Subnet Mask: 255 . 255 . 255 . 0

Default Gateway: 192 . 168 . 1 . 1

Primary DNS: 192 . 168 . 1 . 1

Secondary DNS: . . .

Default VLAN Info: Management VLAN: 1

**Save**

3. Set the management computer to **Obtain an IP address automatically** and **Obtain DNS server address automatically**.

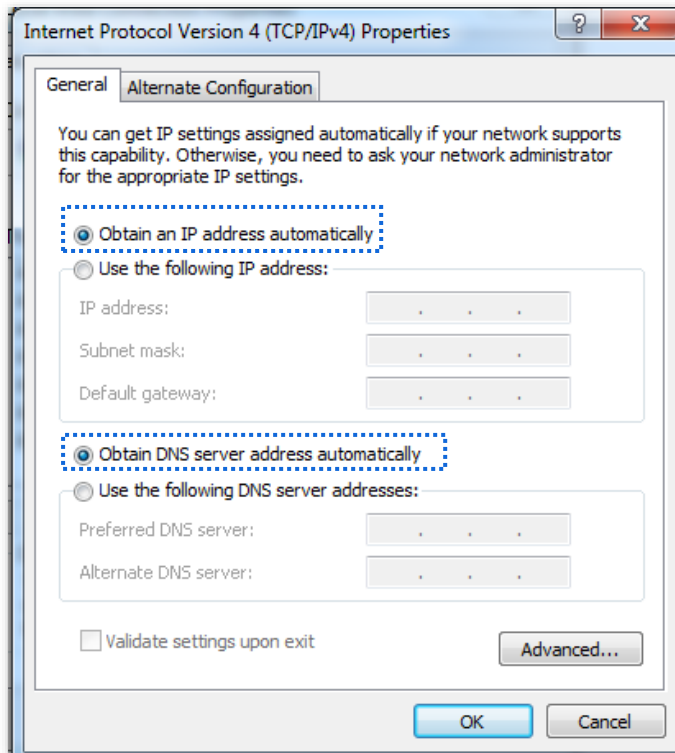

----End

Start a web browser and enter the newly set IP address in the address bar to log in to the web UI of the router again. In the **Network Info** module of the **System** page, you can view that the router is connected to the internet.

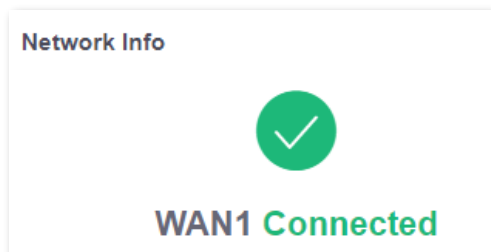



## Acronyms and abbreviations

Acronym or Abbreviation	Full Spelling
ACK	Acknowledge
AES	Advanced Encryption Standard
AH	Authentication Header
AP	Access Point
APSD	Automatic Power Save Delivery
ARP	Address Resolution Protocol
ASCII	American Standard Code for Information Interchange
BW	Bandwidth
CHAP	Challenge Handshake Authentication Protocol
CPU	Central Processing Unit
DDNS	Dynamic Domain Name Service
DDoS	Distributed Denial of Service
DES	Data Encryption Standard
DH	Diffie-Hellman
DHCP	Dynamic Host Configuration Protocol
DHCPv6	Dynamic Host Configuration Protocol for IPv6
DMZ	Demilitarized Zone
DNS	Domain Name System
DPD	Dead Peer Detection
DTIM	Delivery Traffic Indication Map
EDCA	Enhanced Distributed Channel Access

<b>Acronym or Abbreviation</b>	<b>Full Spelling</b>
ERP	Enterprise Resource Planning
ESP	Encapsulating Security Payload
FQDN	Fully Qualified Domain Name
FTP	File Transfer Protocol
GRE	Generic Routing Encapsulation
HTTP	Hypertext Transfer Protocol
HTTPS	Hypertext Transfer Protocol Secure
ICMP	Internet Control Message Protocol
ID	Identity Document
IEEE	Institute of Electrical and Electronics Engineers
IKE	Internet Key Exchange
IP	Internet Protocol
IPsec	Internet Protocol Security
IPTV	Internet Protocol Television
IPv4	Internet Protocol Version 4
IPv6	Internet Protocol Version 6
ISP	Internet Service Provider
L2TP	Layer 2 Tunneling Protocol
LAN	Local Area Network
LCP	Link Control Protocol
LED	Light Emitting Diode
MAC	Medium Access Control
MPDU	MAC Protocol Data Unit

<b>Acronym or Abbreviation</b>	<b>Full Spelling</b>
MPPE	Microsoft Point-to-Point Encryption
MSDU	MAC Service Data Unit
MTU	Maximum Transmission Unit
NAT	Network Address Translation
NTS	Network time server
PAP	Password Authentication Protocol
PFS	Perfect Forward Secrecy
PPP	Point to Point Protocol
PPPoE	Point-to-Point Protocol over Ethernet
PPTP	Point to Point Tunneling Protocol
PVID	Port-based VLAN ID
PoE	Power over Ethernet
QoS	Quality of Service
RA	Router Advertisement
RADIUS	Remote Authentication Dial In User Service
RSSI	Received Signal Strength Indicator
RTS	Request to Send
RX	Receive
SA	Security Association
SDN	Software Defined Network
SLAAC	Stateless Address Autoconfiguration
SMS	Short Message Service
SMTP	Simple Mail Transfer Protocol

<b>Acronym or Abbreviation</b>	<b>Full Spelling</b>
SN	Serial Number
SNMP	Simple Network Management Protocol
SSH	Secure Shell
SSID	Service Set Identifier
SSL	Secure Sockets Layer
TCP	Transmission Control Protocol
TKIP	Temporal Key Integrity Protocol
TX	Transmit
UDP	User Datagram Protocol
UI	User Interface
UPnP	Universal Plug and Play
URL	Uniform Resource Locator
USB	Universal Serial Bus
VLAN	Virtual Local Area Network
VPN	Virtual Private Network
VoIP	Voice over Internet Protocol
WAN	Wide Area Network
WEP	Wired Equivalent Privacy
WLAN	Wireless Local Area Network
WMM	Wi-Fi Multi-Media
WPA	Wi-Fi Protected Access
WPA-PSK	WPA-Preshared Key